

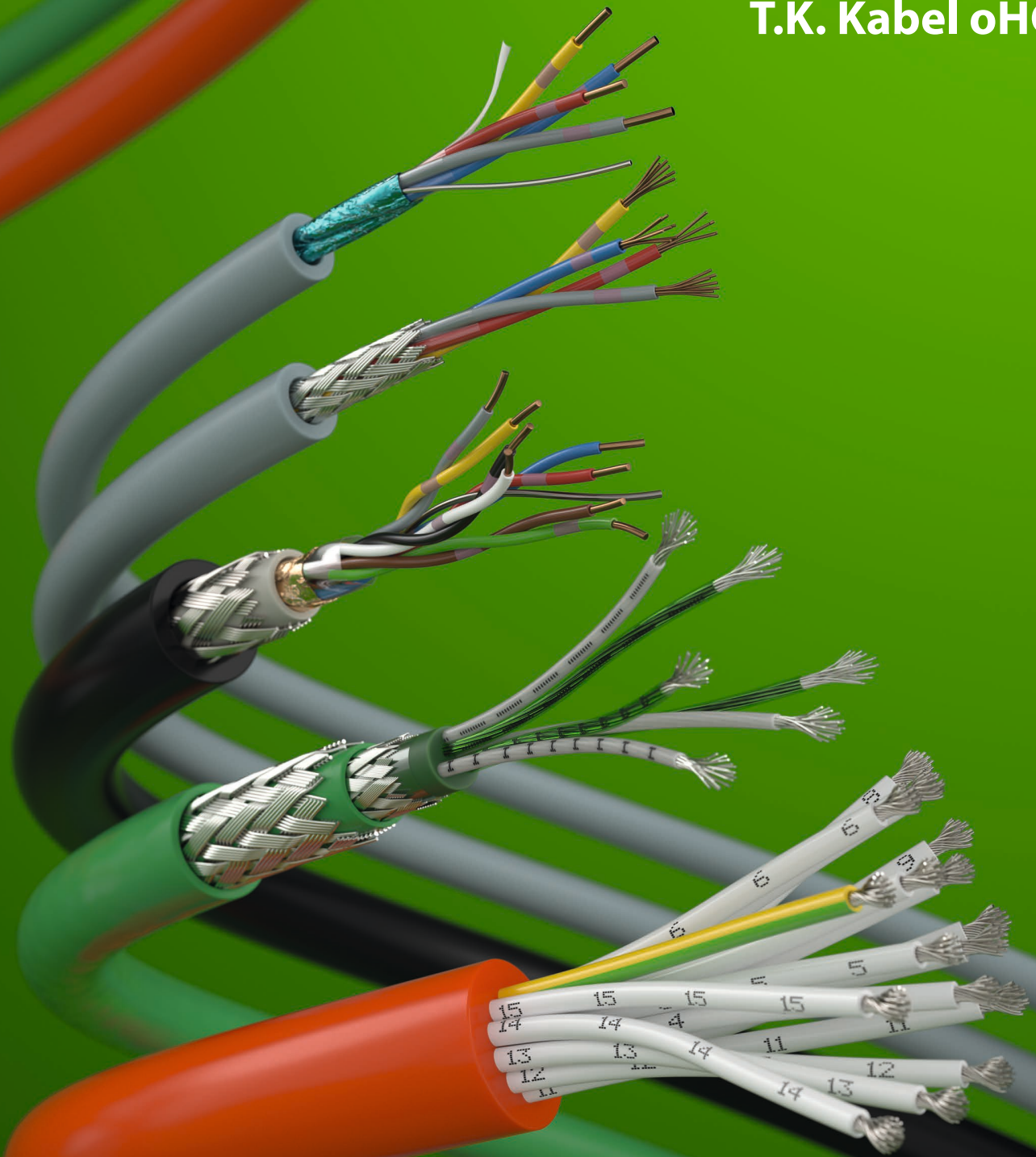

T.K. Kabel oHG



Product Catalogue



T.K. Kabel oHG

TERMITE
PROTECTED
CABLES



RODENT
PROTECTED
CABLES



SPECIAL
CABLES



Production and Distribution of Cables

certified by DIN EN ISO 9001:2008



**CONTROL
CABLES**

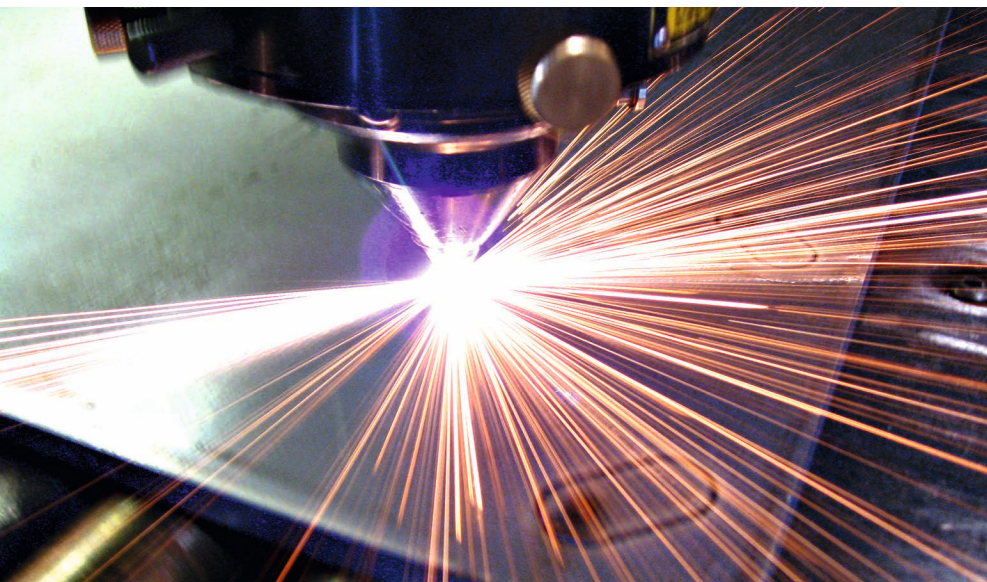

**INDUSTRIAL-
ELECTRONICS**

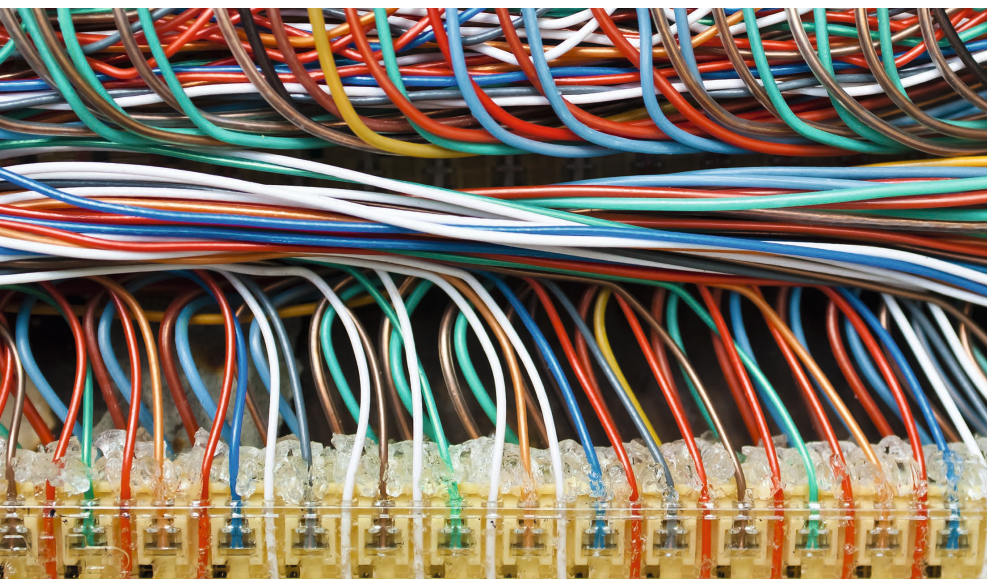

DATA CABLES



T.K. Kabel oHG · Geschwister-Scholl-Straße 11 · 71384 Weinstadt

Phone +49 (0) 7151/60 68 70 · Fax +49 (0) 7151/60 91 00 · info@tk-kabel.de · www.tk-kabel.de



T.K. Kabel oHG



Production and Distribution of Cables

certified by DIN EN ISO 9001:2008

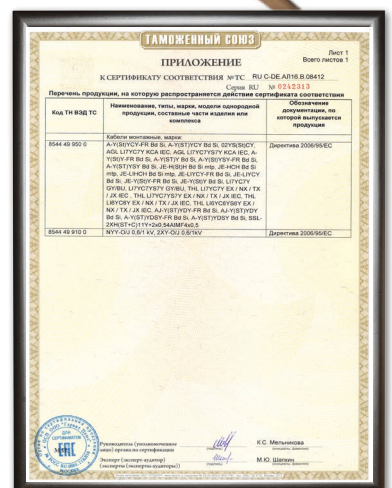



T.K. Kabel oHG

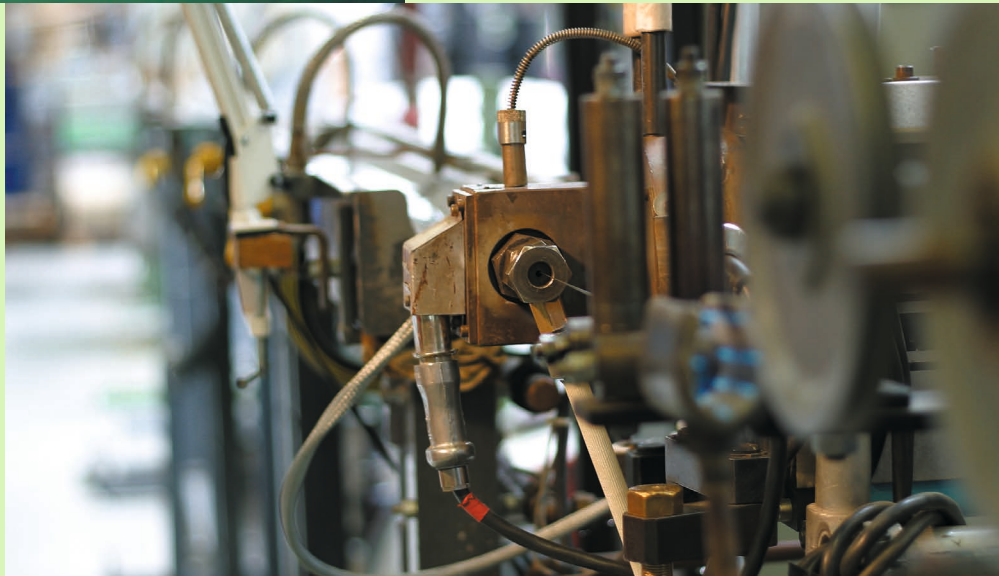
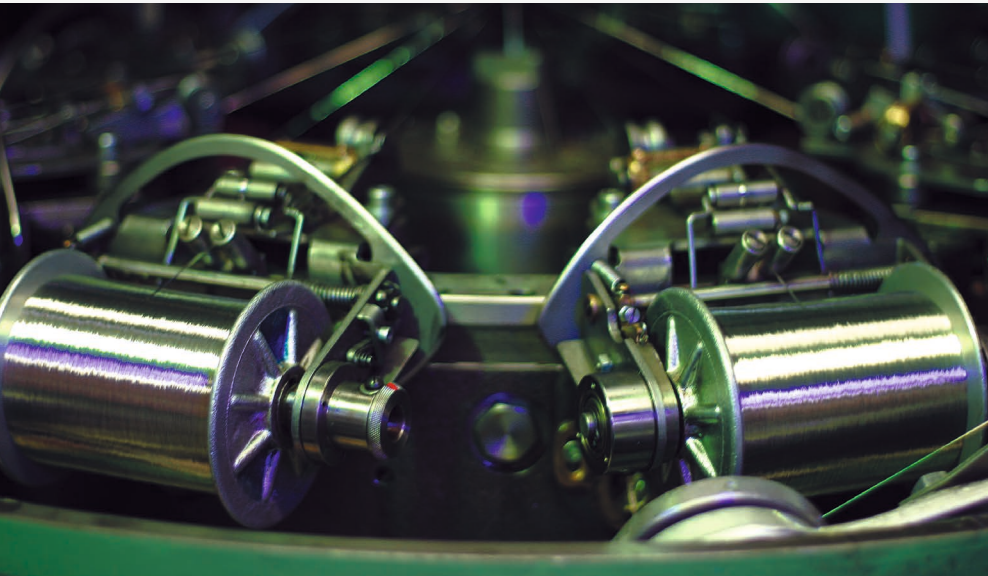

Our Family Business

Cable and Wire Experts since 1984

T.K. Kabel oHG, established in 1984, is a family business, located in Weinstadt. Since our foundation we have been working in the areas of development, production, procurement and distribution of cables and wires. Our extensive selection, ranges from installation cables for industrial electronics by control, compensating and thermo cables, to specially requested cables. Our range is directed at diverse applications, including instrument engineering, mechanical engineering, telecommunications, measurement technology, test engineering, data technology, network technology, and bus technology.

Many years of experience, coupled with our wide and detailed knowledge, ensure that we are specialists in the fields of termite, water and heat resistant special cables. We insert the different types of materials, such as PVC, PVC-FR, halogen-free compounds, PE, PUR, ETFE, FEP and silicone. During this process we ensure all raw materials are of the highest quality.

In order to meet the high quality requirements of our customers we have been certified since 1996 according to DIN EN ISO 9001. In addition we have VDE accreditations and certificates from other institutes.

T.K. Kabel oHG distinguishes itself through short delivery times of cables, especially cables with improved fire behaviour. These cables form part of our extensive in-stock range.

Satisfied customers, the highest standards of quality and a direct, solution-oriented service are important to us. We invite you to benefit from over 30 years know-how and will be glad to help with the development of individual solutions for your projects.



Jürgen Thum



Jochen Thum





T.K. Kabel oHG

INSTALLATION CABLES FOR INDUSTRIAL ELECTRONICS

Indoor cables

JE-Y(ST)Y Bd Si Eca	12
JE-LIYCY Bd Si Eca	13
JE-Y(ST)Y-FR Bd Si Dca	14
JE-LIYCY-FR Bd Si Dca	15
JE-LIYCYSY-FR Bd Si Fca	16
JE-LIY(St)YSY-FR PimF Bd Si Fca	17

JE-H(St)H Bd Si mtp B2ca/Cca/Dca	18
JE-HCH Bd Si mtp B2ca / Cca / Dca	19
JE-LIHCH Bd Si mtp Eca	20
JE-LIHCHSH Bd Si mtp Fca	21

Outdoor cables

A-Y(St)Y Bd Si Fca	22
A-Y(St)YCY Bd Si Fca	23
AJ-Y(St)YDY Bd Si Cu3.5 Fca	24
AJ-Y(St)YDY Bd Si Cu16 Fca	25
A-Y(St)YSY Bd Si Fca	26
A-LIYCY Bd Si Fca	27

A-Y(St)Y-FR Bd Si Fca	28
A-Y(St)YCY-FR Bd Si Fca	29
AJ-Y(St)YDY-FR Bd Si Cu3.5 Fca	30
AJ-Y(St)YDY-FR Bd Si Cu16 Fca	31
AJ-Y(St)YCYDY-FR Bd Si Cu16 Fca	32
A-Y(St)YSY-FR Bd Si Fca	33
A-Y(St)YSYö-FR Bd Si Fca	34
A-LIYCY-FR Bd Si Fca	35
A-LIYCYSY-FR Bd Si Fca	36
AJ-LIYCYDY-FR Bd Si Cu3.5 Fca	37
A-LIY(St)YSY-FR PimF Bd Si Fca	38

A-H(St)HCH Bd Si mtp Fca	39
AJ-H(St)HDH Bd Si Cu3.5 mtp Fca	40
A-H(St)HSH Bd Si mtp Fca	41
AJ-HCHDH Bd Si Cu16 mtp Fca	42
AJ-HCHD2Y Bd Si Cu16 mtp Fca	43
A-LIH(St)HCH Bd Si mtp Fca	44
A-LIHCH Bd Si mtp Fca	45
A-LIHCHCH Bd Si mtp Fca	46
A-LIHCHCH PimF Bd Si mtp Fca	47

SPECIAL CABLES

Indoor cables

JE-Y(St)YT-FR Bd Si	50
JE-LIYCYT-FR Bd Si	51
JE-LIYCYSYT-FR Bd Si	52
JE-LIH(St)HSO Bd Si mtp Fca	53
JE-LIHCHSOT Bd Si mtp	54
JE-LIHCHSHSOT Bd Si mtp	55

Outdoor cables

AJ-Y(St)YDYT-FR Bd Si Cu3.5	56
A-Y(St)YSYT-FR Bd Si	57
A-H(St)HSO Bd Si mtp Fca	58
A-H(St)HCHSOT Bd Si mtp	59
A-H(St)HDSHSOT Bd Si mtp	60
AJ-HCHDHSO Bd Si Cu16 mtp Fca	61

MEASURING AND CONTROL CABLES

RD-Y(St)Y Bd Eca	64
RD-H(St)H Bd Eca	65

BUS CABLES

02YS(St)CY	68
02YS(St)CY2Y	69
02YSY(St)CY-FR	70
02YS(St)CH	71

CONTROL CABLES

LIYCY	74
YSLY-OZ/JZ	76
YSLCY-OZ/JZ	80
HSLH-OZ/JZ	84
LI7YC7Y n x 2 x 0.5 GY/BU	86
LI7YC7Y n x 2 x 1.0 GY/BU	87
LI7YC7YS7Y n x 2 x 0.5 GY/BU	88
LI7YC7Y 2 x 1.5 GY / BU / BK	89
LI6Y 1 x 0.75	90
LI6YC6Y-O/J n x 0.75 GY/BU/BK	91
LI6YC6Y (4+2) x 0.75 GY/BU	92
LI6YC6Y-O 24 x 0.75 BK	93



Contents

LI6YC6Y-O/J 32 x 0.75 BK	94
LI6YC6Y-O/J n x 1.5 GY/BU/BK	95
LI6YC6Y-O/J 3 x 2.5 BK	96
LI6YC6Y-O/J 4 x AWG 14 BK	97
LI6YC6YS-O/J 3 x 2.5	98
LI6YC6YS6Y-J 18 x 0.5 BK	99
LI6YC6YS6Y-O/J n x 0.75 BK	100
LI6YC6YS6Y-O/J n x 1.5 BK	101

LISOSI 0.75	102
LISOSISOSI-O/J n x 1.5 BK	103
LISOSICSOSI n x 2 x 0.5 GY/BU	104
LISOSICSOSI-O/J n x 0.75 GY/BU	105
LISOSICSOSI-O/J n x 1.5 GY/BU	106
LISOSICSOSI 4 x 1.5 + 3 x 0.38	107
LISOSI51Y 1 x 1.5	108

COMPENSATING CABLES

AGL LI7YC7Y NC IEC n x 2 x 0.75	112
AGL LI7YC7Y KCA IEC n x 2 x 0.75 Eca/Fca	113
AGL LI7YC7Y KCA IEC 2 x 2 x 0.75 nr	114
AGL LI7YC7Y KCA IEC n x 2 x 1.0	115
AGL LI7YC7YS7Y KCA IEC n x 2 x 0.75	116

AGL LI6YC6Y KCA DIN n x 0.75	117
------------------------------	-----

AGL LISI(St)SI KCA IEC 2 x 1.5	118
AGL LISOSICSOSI KCA (IEC,DIN) n x 0.75	119
AGL LISOSICSOSI KCA IEC n x 2 x 0.75	120

THERMO CABLES

THL LIYCY KX IEC n x 1.5	124
THL LI7YC7Y TX IEC n x 2 x 0.75	125
THL LI7YC7Y EX IEC n x 2 x 0.75	126
THL LI7YC7Y JX IEC n x 2 x 0.75	127
THL LI7YC7YS7Y JX IEC n x 2 x 0.75	128

THL LI6YC6Y NX IEC n x 2 x 0.75	129
THL LISOSICSOSI EX IEC n x 2 x 0.75	130

POWER CABLES

NY-Y-O/J 0.6/1 kV	134
NY-Y-OZ/JZ 0.6/1 kV	136
NYCY 0.6/1 kV	138
NYCWY 0.6/1 kV	140
NYYSYö-FR-O/J 0.6/1 kV	141

2XY-O/J (R2V) 0.6/1kV	142
N2XY-O/J 0.6/1kV	144
N2XCY 0.6/1kV	148
N2XY-FR-O/J 0.6/1kV Fca	150
N2XH-O/J 0.6/1kV	154
N2XCH 0.6/1kV	156

INSULATED WIRES

H05V-U/-K	160
H07V-U/-K	161

DATA CABLES

SLAN 1000 S/FTP 4PR AWG 23/1	164
XLAN 1000 S/FTP 4PR AWG 23/1	165
XLAN 1200 S/FTP 4PR AWG 22/1	166
XLAN 1500 S/FTP 4PR AWG 22/1	167
XLAN flex 1000 S/FTP 4PR AWG 26/7	168
XLAN flex 600 S/FTP 4PR AWG 26/7	169

TECHNICAL INFORMATION

Core identification according to vde 0815	172
Core identification according to din 47100	173
Core identification according to din vde 0293	174
Colour codes	174
Strand construction & conductor resistance acc. vde 0295	175
Strand conversion AWG	176
Basic material properties	177
Intern. ident. colours for temp. measurement technology	178
LAN - Fire behaviour, fire propagation and calorific potential	179
LAN - Planning and installation advice	180
LAN - Planning and installation advice	181
LAN - Instructions for connection	181
LAN - Key cable parameters	182
Codes	184
KTG - cable drums	186
Non-returnable drums	188
Properties and test specifications	190
CE-Identification	192
General	193
Environment protection	193
General Terms and Conditions	194





T.K. Kabel oHG

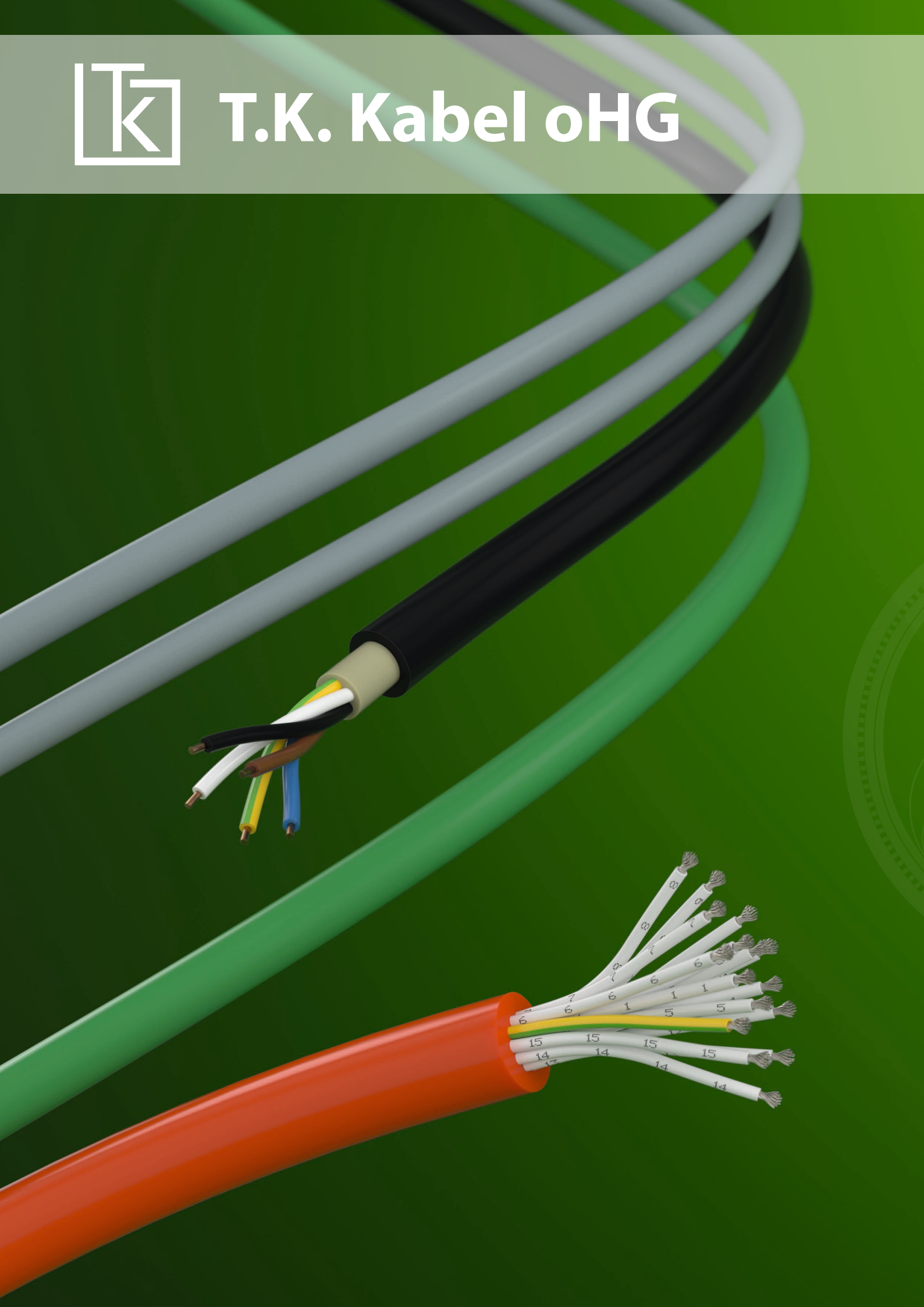

Installation cables for industrial electronics

Indoor cables

JE-Y(ST)Y Bd Si Eca	12
JE-LIYCY Bd Si Eca	13
JE-Y(ST)Y-FR Bd Si Dca	14
JE-LIYCY-FR Bd Si Dca	15
JE-LIYCYSY-FR Bd Si Fca	16
JE-LIY(ST)YSY-FR PimF Bd Si Fca	17
JE-H(ST)H Bd Si mtp B2ca / Cca / Dca	18
JE-HCH Bd Si mtp B2ca / Cca / Dca	19
JE-LIHCH Bd Si mtp Eca	20
JE-LIHCHSH Bd Si mtp Fca	21

Outdoor cables

A-Y(ST)Y Bd Si Fca	22
A-Y(ST)YCY Bd Si Fca	23
AJ-Y(ST)YDY Bd Si Cu3.5 Fca	24
AJ-Y(ST)YDY Bd Si Cu16 Fca	25
A-Y(ST)YSY Bd Si Fca	26
A-LIYCY Bd Si Fca	27
A-Y(ST)Y-FR Bd Si Fca	28
A-Y(ST)YCY-FR Bd Si Fca	29
AJ-Y(ST)YDY-FR Bd Si Cu3.5 Fca	30
AJ-Y(ST)YDY-FR Bd Si Cu16 Fca	31
AJ-Y(ST)YCYDY-FR Bd Si Cu16 Fca	32
A-Y(ST)YSY-FR Bd Si Fca	33
A-Y(ST)YSYö-FR Bd Si Fca	34
A-LIYCY-FR Bd Si Fca	35
A-LIYCYSY-FR Bd Si Fca	36
AJ-LIYCYDY-FR Bd Si Cu3.5 Fca	37
A-LIY(ST)YSY-FR PimF Bd Si Fca	38
A-H(ST)HCH Bd Si mtp Fca	39
AJ-H(ST)HDH Bd Si Cu3.5 mtp Fca	40
A-H(ST)HSH Bd Si mtp Fca	41
AJ-HCHDH Bd Si Cu16 mtp Fca	42
AJ-HCHD2Y Bd Si Cu16 mtp Fca	43
A-LIH(ST)HCH Bd Si mtp Fca	44
A-LIHCH Bd Si mtp Fca	45
A-LIHCHCH Bd Si mtp Fca	46
A-LIHCHCH PimF Bd Si mtp Fca	47

JE-Y(ST)Y Bd Si Eca

acc. to DIN VDE 0815

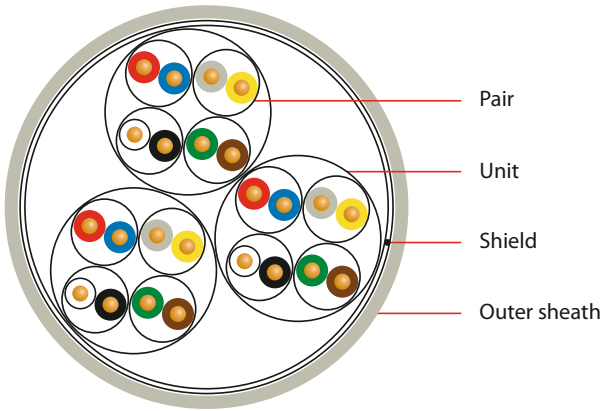

APPLICATION

For information transmission in dry and moist production sites, in and under plaster, as well as outdoors for fixed installation. Not approved for power and underground installation.

CONSTRUCTION

Conductor: copper, solid, bare (Ø 0.8 mm)

Core insulation: PVC

Core stranding: 2 cores to pair, 4 pairs to unit, units in layers;
2 x 2 as star quad

Lapping: plastic foil

Shield: tinned drain wire (Ø 0.8 mm); plastic-laminated aluminium foil

Outer sheath: PVC; colour: pebble grey RAL 7032 or blue RAL 5015

ELECTRICAL CHARACTERISTICS

(Conductor) loop resistance max.	73.2 Ω/km
Insulation resistance min.	100 MΩ x km
Mutual capacitance (800 Hz) max.	100 nF/km <small>2 and 4 pair cable plus 20% permitted 1 pair 180nF/km</small>
Capacitance unbalance (800 Hz) max.	200 pF/100m <small>20% of values, min one value up to 400 pF</small>
Test voltage core-core	500 V 50 Hz 1 min
Test voltage core-screen	2000 V 50 Hz 1 min
Peak operating voltage	225 V

THERMAL & MECHANICAL PROPERTIES

Temperature range during installation	-5°C to +50°C
Temperature range stationary	-30°C to +70°C
Minimum bending radius	7.5 x diameter

Dimension	Sheath thickness approx. mm	Diameter approx. mm	Cable weight approx. kg/km	Copper index kg/km
1 x 2 x 0.8	1.0	5.0	36	15
2 x 2 x 0.8	1.0	6.6	55	25
4 x 2 x 0.8	1.0	8.3	87	45
8 x 2 x 0.8	1.0	10.5	146	85
12 x 2 x 0.8	1.0	11.8	200	126
16 x 2 x 0.8	1.2	13.5	270	166
20 x 2 x 0.8	1.2	14.7	325	206
24 x 2 x 0.8	1.2	15.8	375	246
28 x 2 x 0.8	1.2	16.2	425	287
32 x 2 x 0.8	1.4	19.0	510	327
36 x 2 x 0.8	1.4	20.3	565	367
40 x 2 x 0.8	1.4	20.7	610	407
48 x 2 x 0.8	1.4	22.3	720	488
60 x 2 x 0.8	1.6	24.3	895	608
80 x 2 x 0.8	1.6	29.5	1200	809
96 x 2 x 0.8	1.6	30.0	1380	1015
100 x 2 x 0.8	1.8	31.0	1450	1420

Subject to changes due to technical progress and error



JE-LIYCY Bd Si Eca

acc. to DIN VDE 0815

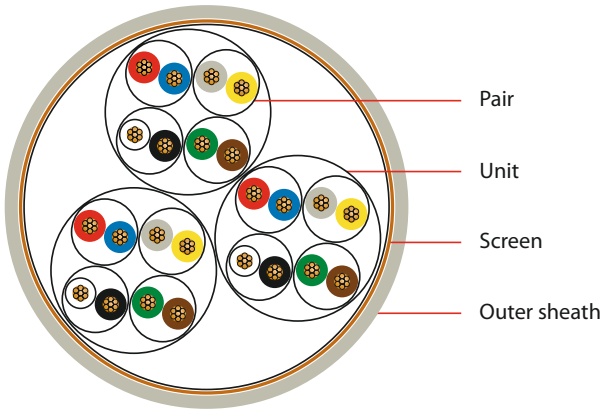

Dimension	Sheath thickness approx. mm	Diameter approx. mm	Cable weight approx. kg/km	Copper index kg/km
1 x 2 x 0.5	1.0	6.2	60	35
2 x 2 x 0.5	1.0	7.0	75	48
4 x 2 x 0.5	1.0	8.6	120	84
8 x 2 x 0.5	1.0	12.0	200	140
12 x 2 x 0.5	1.2	13.1	265	193
16 x 2 x 0.5	1.2	14.3	325	243
20 x 2 x 0.5	1.2	15.5	385	292
24 x 2 x 0.5	1.2	16.8	450	342
32 x 2 x 0.5	1.4	20.5	610	435
40 x 2 x 0.5	1.4	22.5	720	531
48 x 2 x 0.5	1.6	24.0	850	637

APPLICATION

For information transmission in dry and moist production sites, in and under plaster, as well as outdoors for fixed installation. Not approved for power and underground installation.

CONSTRUCTION

Conductor: copper strand, bare; $7 \times 0.3 \text{ mm} = 0.5 \text{ mm}^2$ ($\varnothing 0.9 \text{ mm}$)

Core insulation: PVC

Core stranding: 2 cores to pair, 4 pairs to unit, units in layers; 2 x 2 as star quad

Lapping: plastic foil

Screen: tinned copper wire braid ($\varnothing 0.2 \text{ mm}$); optical coverage approx. 80 %

Outer sheath: PVC; colour: pebble grey RAL 7032 or blue RAL 5015

ELECTRICAL CHARACTERISTICS

(Conductor) loop resistance max.	78.4 Ω /km
Insulation resistance min.	100 M Ω x km
Mutual capacitance (800 Hz) max.	100 nF/km 2 and 4 pair cable plus 20% permitted 1 pair 180nF/km
Capacitance unbalance (800 Hz) max.	200 pF/100m 20% of values, min one value up to 400 pF
Test voltage core-core	500 V 50 Hz 1 min
Test voltage core-screen	2000 V 50 Hz 1 min
Peak operating voltage	225 V

THERMAL & MECHANICAL PROPERTIES

Temperature range during installation	-5°C to +50°C
Temperature range stationary	-30°C to +70°C
Minimum bending radius	7.5 x diameter

Subject to changes due to technical progress and error



JE-Y(ST)Y-FR Bd Si Dca

in resemblance to DIN VDE 0815

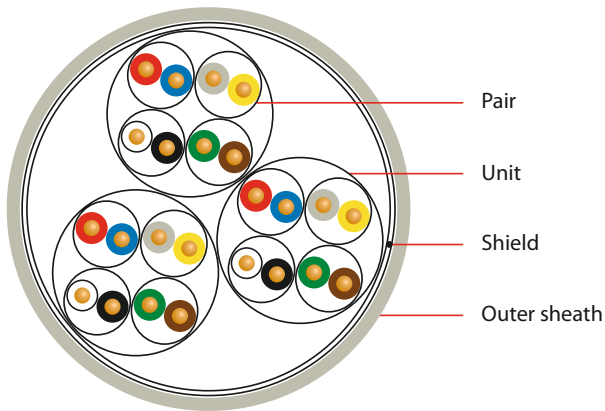

APPLICATION

For information transmission in dry and moist production sites, in and under plaster, as well as outdoors for fixed installation. Not approved for power and underground installation.

CONSTRUCTION

- Conductor:** copper, solid, bare (Ø 0.8 mm)
- Core insulation:** PVC
- Core stranding:** 2 cores to pair, 4 pairs to unit, units in layers; 2 x 2 as star quad
- Lapping:** plastic foil
- Shield:** tinned drain wire (Ø 0.8 mm); plastic-laminated aluminium foil
- Outer sheath:** PVC-FR; colour: pebble grey RAL 7032 or blue RAL 5015

BEHAVIOUR UNDER FIRE CONDITIONS

Fire retardant: IEC 60332-3-24, DIN EN 60332-3-24
Low smoke and fume

ELECTRICAL CHARACTERISTICS

(Conductor) loop resistance max.	73.2 Ω/km
Insulation resistance min.	100 MΩ x km
Mutual capacitance (800 Hz) max.	100 nF/km <small>2 and 4 pair cable plus 20% permitted 1 pair 180nF/km</small>
Capacitance unbalance (800 Hz) max.	200 pF/100m <small>20% of values, min one value up to 400 pF</small>
Test voltage core-core	500 V 50 Hz 1 min
Test voltage core-screen	2000 V 50 Hz 1 min
Peak operating voltage	225 V

THERMAL & MECHANICAL PROPERTIES

Temperature range during installation	-5°C to +50°C
Temperature range stationary	-30°C to +70°C
Minimum bending radius	7.5 x diameter

Dimension	Sheath thickness approx. mm	Diameter approx. mm	Cable weight approx. kg/km	Copper index kg/km
1 x 2 x 0.8	1.0	5.0	36	15
2 x 2 x 0.8	1.0	6.6	55	25
4 x 2 x 0.8	1.0	8.3	87	45
8 x 2 x 0.8	1.0	10.5	146	85
12 x 2 x 0.8	1.0	11.8	200	126
16 x 2 x 0.8	1.2	13.5	270	166
20 x 2 x 0.8	1.2	14.7	325	206
24 x 2 x 0.8	1.2	15.8	375	246
28 x 2 x 0.8	1.2	16.2	425	287
32 x 2 x 0.8	1.4	19.0	510	327
36 x 2 x 0.8	1.4	20.3	565	367
40 x 2 x 0.8	1.4	20.7	610	407
48 x 2 x 0.8	1.4	22.3	720	488
60 x 2 x 0.8	1.6	24.3	895	608
80 x 2 x 0.8	1.6	29.5	1200	809
96 x 2 x 0.8	1.6	30.0	1380	1015
100 x 2 x 0.8	1.8	31.0	1450	1420

Subject to changes due to technical progress and error



JE-LIYCY-FR Bd Si Dca

in resemblance to DIN VDE 0815

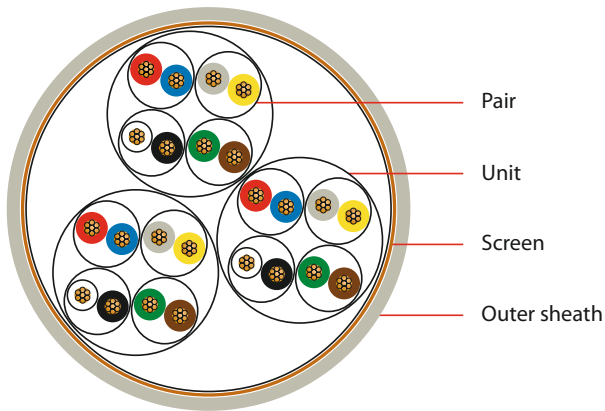

Dimension	Sheath thickness approx. mm	Diameter approx. mm	Cable weight approx. kg/km	Copper index kg/km
1 x 2 x 0.5	1.0	6.2	60	35
2 x 2 x 0.5	1.0	7.0	75	48
4 x 2 x 0.5	1.0	8.6	120	84
8 x 2 x 0.5	1.0	12.0	200	140
12 x 2 x 0.5	1.2	13.1	265	193
16 x 2 x 0.5	1.2	14.3	325	243
20 x 2 x 0.5	1.2	15.5	385	292
24 x 2 x 0.5	1.2	16.8	450	342
32 x 2 x 0.5	1.4	20.5	610	435
40 x 2 x 0.5	1.4	22.5	720	531
48 x 2 x 0.5	1.6	24.0	850	637

APPLICATION

For information transmission in dry and moist production sites, in and under plaster, as well as outdoors for fixed installation. Not approved for power and underground installation.

CONSTRUCTION

Conductor: copper strand, bare; $7 \times 0.3 \text{ mm} = 0.5 \text{ mm}^2$ ($\varnothing 0.9 \text{ mm}$)

Core insulation: PVC

Core stranding: 2 cores to pair, 4 pairs to unit, units in layers; 2 x 2 as star quad

Lapping: plastic foil

Screen: tinned copper wire braid ($\varnothing 0.2 \text{ mm}$); optical coverage approx. 80 %

Outer sheath: PVC-FR; colour: pebble grey RAL 7032 or blue RAL 5015

BEHAVIOUR UNDER FIRE CONDITIONS

Fire retardant: IEC 60332-3-24, DIN EN 60332-3-24

Low smoke and fume

ELECTRICAL CHARACTERISTICS

(Conductor) loop resistance max.	78.4 Ω /km
Insulation resistance min.	100 $M\Omega \times \text{km}$
Mutual capacitance (800 Hz) max.	100 nF/km 2 and 4 pair cable plus 20% permitted 1 pair 180nF/km
Capacitance unbalance (800 Hz) max.	200 pF/100m 20% of values, min one value up to 400 pF
Test voltage core-core	500 V 50 Hz 1 min
Test voltage core-screen	2000 V 50 Hz 1 min
Peak operating voltage	225 V

THERMAL & MECHANICAL PROPERTIES

Temperature range during installation	-5°C to +50°C
Temperature range stationary	-30°C to +70°C
Minimum bending radius	7.5 x diameter

Subject to changes due to technical progress and error



JE-LIYCYSY-FR Bd Si Fca

in resemblance to DIN VDE 0815

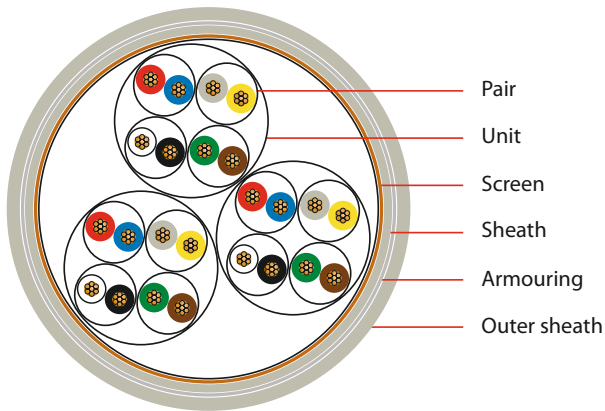

APPLICATION

For information transmission in dry and moist production sites, in and under plaster, as well as outdoors for fixed installation. Not approved for power and underground installation.

CONSTRUCTION

Conductor: copper strand, bare; $7 \times 0.3 \text{ mm} = 0.5 \text{ mm}^2$ ($\varnothing 0.9 \text{ mm}$)

Core insulation: PVC

Core stranding: 2 cores to pair, 4 pairs to unit, units in layers; 2 x 2 as star quad

Lapping: plastic foil

Screen: tinned copper wire braid ($\varnothing 0.2 \text{ mm}$); optical coverage approx. 80 %

Sheath: PVC

Armouring: galvanized steel wire braid ($\varnothing 0.24 \text{ mm}$); optical coverage approx. 80%

Outer sheath: PVC-FR; colour: pebble grey RAL 7032 or blue RAL 5015

BEHAVIOUR UNDER FIRE CONDITIONS

Fire retardant: IEC 60332-3-24, DIN EN 60332-3-24

Low smoke and fume

Dimension	Sheath thickness approx. mm	Diameter approx. mm	Cable weight approx. kg/km	Copper index kg/km
2 x 2 x 0.5	1.4	11.0	190	48
4 x 2 x 0.5	1.4	13.0	260	84
8 x 2 x 0.5	1.4	16.0	385	140
12 x 2 x 0.5	1.4	17.0	470	193
16 x 2 x 0.5	1.4	18.0	545	243
20 x 2 x 0.5	1.4	19.5	620	292
32 x 2 x 0.5	1.8	25.5	970	435
40 x 2 x 0.5	1.8	27.0	1120	531

ELECTRICAL CHARACTERISTICS

(Conductor) loop resistance max.	78.4 Ω /km
Insulation resistance min.	100 M Ω x km
Mutual capacitance (800 Hz) max.	100 nF/km 2 and 4 pair cable plus 20% permitted 1 pair 180nF/km
Capacitance unbalance (800 Hz) max.	200 pF/100m 20% of values, min one value up to 400 pF
Test voltage core-core	500 V 50 Hz 1 min
Test voltage core-screen	2000 V 50 Hz 1 min
Peak operating voltage	225 V

THERMAL & MECHANICAL PROPERTIES

Temperature range during installation	-5°C to +50°C
Temperature range stationary	-30°C to +70°C
Minimum bending radius	10 x diameter

Subject to changes due to technical progress and error



T.K. Kabel oHG · Geschwister-Scholl-Straße 11 · 71384 Weinstadt

Phone +49 (0) 7151/60 68 70 · Fax +49 (0) 7151/60 91 00 · info@tk-kabel.de · www.tk-kabel.de

JE-LIY(St)YSY-FR PimF Bd Si Fca

in resemblance to DIN VDE 0815

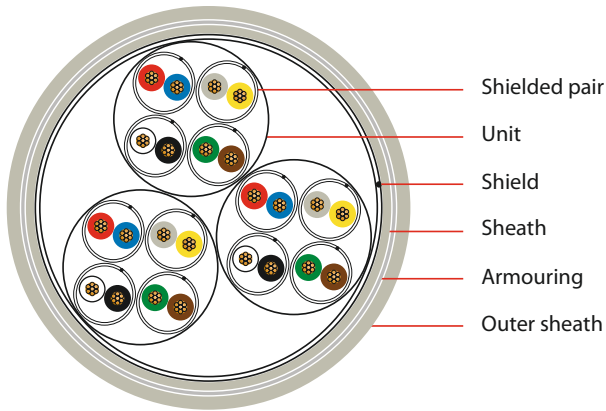

Dimension	Sheath thickness approx. mm	Diameter approx. mm	Cable weight approx. kg/km	Copper index kg/km
2 x 2 x 0.5	1.0	11.4	162	28
4 x 2 x 0.5	1.2	12.0	198	50
8 x 2 x 0.5	1.2	17.4	370	96
12 x 2 x 0.5	1.4	18.7	445	141
16 x 2 x 0.5	1.4	20.1	570	186
20 x 2 x 0.5	1.4	22.1	645	233

APPLICATION

For information transmission in dry and moist production sites, in and under plaster, as well as outdoors for fixed installation. Not approved for power and underground installation.

CONSTRUCTION

Conductor: copper strand, bare; 7 x 0.3 mm = 0.5 mm² (Ø 0.9 mm)

Core insulation: PVC

Shielded pairs: each pair one layer plastic tape;
 drain wire: tinned copper strand 7 x 0.16 mm;
 one layer plastic laminated aluminium foil

Core stranding: 2 cores to pair, 4 pairs to unit, units in layers;
 2 x 2 as star quad

Lapping: plastic foil

Shield: tinned drain wire (Ø 0.8 mm); plastic-laminated aluminium foil

Sheath: PVC

Armouring: galvanized steel wire braid (Ø 0.24 mm);
 optical coverage approx. 80%

Outer sheath: PVC-FR; colour: pebble grey RAL 7032 or blue RAL 5015

BEHAVIOUR UNDER FIRE CONDITIONS

Fire retardant: IEC 60332-3-24, DIN EN 60332-3-24

Low smoke and fume

ELECTRICAL CHARACTERISTICS

(Conductor) loop resistance max.	78.4 Ω/km
Insulation resistance min.	100 MΩ x km
Mutual capacitance (800 Hz) max.	180 nF/km
Capacitance unbalance (800 Hz) max.	200 pF/100m <small>20% of values, min one value up to 400 pF</small>
Test voltage core-core	500 V 50 Hz 2 min
Test voltage core-screen	2000 V 50 Hz 2 min
Peak operating voltage	225 V

THERMAL & MECHANICAL PROPERTIES

Temperature range during installation	-5°C to +50°C
Temperature range stationary	-30°C to +70°C
Minimum bending radius	15 x diameter

Subject to changes due to technical progress and error



JE-H(St)H Bd Si mtp* B2ca/Cca/Dca

acc. to DIN VDE 0815

* capable of maxi-termi-point

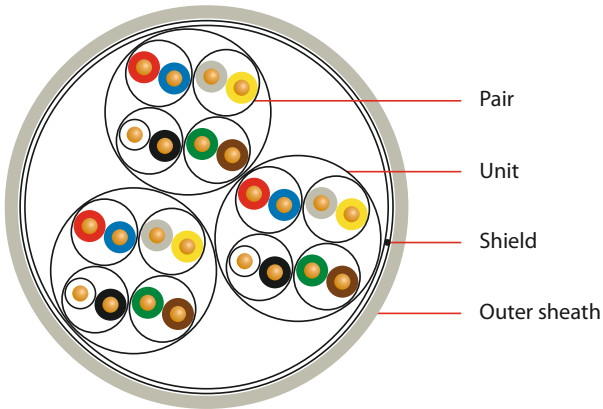

APPLICATION

This halogen-free, flame-resistant cable is used where increased fire protection of persons, material goods and buildings is required. It serves for signal transmission in communication systems with fixed installation. Not approved for power installation. Due to water absorption the cable should only be laid directly in earth or water if a protective conduit is used.

CONSTRUCTION

Conductor: copper, solid, bare (Ø 0.8 mm)

Core insulation: halogen-free compound

Core stranding: 2 cores to pair, 4 pairs to unit, units in layers; 2 x 2 as star quad

Lapping: plastic foil

Shield: tinned drain wire (Ø 0.8 mm); plastic-laminated aluminium foil

Outer sheath: halogen-free compound; colour: pebble grey RAL 7032 or blue RAL 5015

BEHAVIOUR UNDER FIRE CONDITIONS

Zero halogen, non corrosive gases: IEC 60754-2, DIN EN 50267

Flame retardant: IEC 60332-1-2, DIN EN 60332-1-2

Fire retardant: IEC 60332-3-24, DIN EN 60332-3-24

Smoke density: IEC 61034, DIN EN 61034

Dimension	Sheath thickness approx. mm	Diameter approx. mm	Cable weight approx. kg/km	Copper index kg/km
2 x 2 x 0.8	1.0	6.0	55	25
4 x 2 x 0.8	1.0	7.7	90	45
8 x 2 x 0.8	1.0	10.5	155	85
12 x 2 x 0.8	1.0	11.5	205	126
16 x 2 x 0.8	1.0	12.2	255	166
20 x 2 x 0.8	1.2	14.0	325	206
24 x 2 x 0.8	1.2	14.9	380	246
32 x 2 x 0.8	1.4	18.6	515	327
40 x 2 x 0.8	1.4	20.0	620	407

ELECTRICAL CHARACTERISTICS

(Conductor) loop resistance max.	73.2 Ω/km
Insulation resistance min.	100 MΩ x km
Mutual capacitance (800 Hz) max.	120 nF/km 2 and 4 pair cable plus 20% permitted 1 pair 180nF/km
Capacitance unbalance (800 Hz) max.	200 pF/100m 20% of values, min one value up to 400 pF
Test voltage core-core	500 V 50 Hz 1 min
Test voltage core-screen	2000 V 50 Hz 1 min
Peak operating voltage	225 V

THERMAL & MECHANICAL PROPERTIES

Temperature range during installation	-5°C to +50°C
Temperature range stationary	-30°C to +70°C
Minimum bending radius	7.5 x diameter

Subject to changes due to technical progress and error



JE-HCH Bd Si mtp* B2ca / Cca / Dca

acc. to DIN VDE 0815

* capable of maxi-termi-point

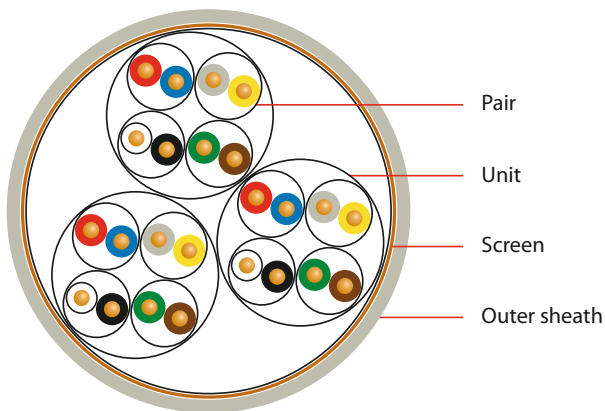

Dimension	Sheath thickness approx. mm	Diameter approx. mm	Cable weight approx. kg/km	Copper index kg/km
1 x 2 x 0.8	1.0	6.0	50	30
2 x 2 x 0.8	1.0	6.6	75	48
4 x 2 x 0.8	1.0	8.4	115	84
8 x 2 x 0.8	1.0	11.3	190	140
12 x 2 x 0.8	1.2	12.7	260	189
16 x 2 x 0.8	1.2	13.8	320	239
20 x 2 x 0.8	1.2	15.0	375	286
32 x 2 x 0.8	1.4	18.8	575	429
40 x 2 x 0.8	1.4	22.0	710	499

APPLICATION

This halogen-free, flame-resistant cable is used where increased fire protection of persons, material goods and buildings is required. It serves for signal transmission in communication systems with fixed installation. Not approved for power installation. Due to water absorption the cable should only be laid directly in earth or water if a protective conduit is used.

CONSTRUCTION

- Conductor:** copper, solid, bare (Ø 0.8 mm)
- Core insulation:** halogen-free compound
- Core stranding:** 2 cores to pair, 4 pairs to unit, units in layers; 2 x 2 as star quad
- Lapping:** plastic foil
- Screen:** tinned copper wire braid (Ø 0.2 mm)
- Outer sheath:** halogen-free compound; colour: pebble grey RAL 7032 or blue RAL 5015

BEHAVIOUR UNDER FIRE CONDITIONS

- Zero halogen, non corrosive gases: IEC 60754-2, DIN EN 50267
- Flame retardant: IEC 60332-1-2, DIN EN 60332-1-2
- Fire retardant: IEC 60332-3-24, DIN EN 60332-3-24
- Smoke density: IEC 61034, DIN EN 61034

ELECTRICAL CHARACTERISTICS

(Conductor) loop resistance max.	73.2 Ω/km
Insulation resistance min.	100 MΩ x km
Mutual capacitance (800 Hz) max.	120 nF/km 2 and 4 pair cable plus 20% permitted 1 pair 180nF/km
Capacitance unbalance (800 Hz) max.	200 pF/100m 20% of values, min. one value max. 400 pF
Test voltage core-core	500 V 50 Hz 1 min
Test voltage core-screen	2000 V 50 Hz 1 min
Peak operating voltage	225 V

THERMAL & MECHANICAL PROPERTIES

Temperature range during installation	-5°C to +50°C
Temperature range stationary	-30°C to +70°C
Minimum bending radius	10 x diameter

Subject to changes due to technical progress and error



JE-LIHCH Bd Si mtp* Eca

acc. to DIN VDE 0815

* capable of maxi-termi-point

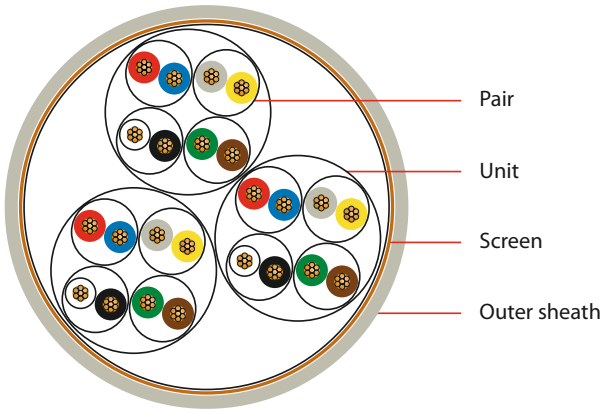

Dimension	Sheath thickness approx. mm	Diameter approx. mm	Cable weight approx. kg/km	Copper index kg/km
1 x 2 x 0.5	1.0	6.2	60	35
2 x 2 x 0.5	1.0	6.8	75	48
4 x 2 x 0.5	1.0	8.7	125	84
8 x 2 x 0.5	1.0	12.9	225	140
12 x 2 x 0.5	1.2	13.6	280	193
16 x 2 x 0.5	1.2	14.7	345	243
20 x 2 x 0.5	1.2	15.9	405	292
24 x 2 x 0.5	1.4	17.2	470	342
32 x 2 x 0.5	1.4	20.5	620	435
40 x 2 x 0.5	1.6	22.5	740	531

APPLICATION

This halogen-free, flame-resistant cable is used where increased fire protection of persons, material goods and buildings is required. It serves for signal transmission in communication systems with fixed installation. Not approved for power installation. Due to water absorption the cable should only be laid directly in earth or water if a protective conduit is used.

CONSTRUCTION

Conductor: copper strand, bare; $7 \times 0.3 \text{ mm} = 0.5 \text{ mm}^2$ ($\varnothing 0.9 \text{ mm}$)

Core insulation: halogen-free compound

Core stranding: 2 cores to pair, 4 pairs to unit, units in layers; 2 x 2 as star quad

Lapping: plastic foil

Screen: tinned copper wire braid ($\varnothing 0.2 \text{ mm}$)

Outer sheath: halogen-free compound; colour: pebble grey RAL 7032 or blue RAL 5015

BEHAVIOUR UNDER FIRE CONDITIONS

Zero halogen, non corrosive gases: IEC 60754-2, DIN EN 50267

Flame retardant: IEC 60332-1-2, DIN EN 60332-1-2

Fire retardant: IEC 60332-3-24, DIN EN 60332-3-24

Smoke density: IEC 61034, DIN EN 61034

ELECTRICAL CHARACTERISTICS

(Conductor) loop resistance max.	78.4 Ω /km
Insulation resistance min.	100 M Ω x km
Mutual capacitance (800 Hz) max.	120 nF/km 2 and 4 pair cable plus 20% permitted 1 pair 180nF/km
Capacitance unbalance (800 Hz) max.	200 pF/100m 20% of values, min one value up to 400 pF
Test voltage core-core	500 V 50 Hz 1 min
Test voltage core-screen	2000 V 50 Hz 1 min
Peak operating voltage	225 V

THERMAL & MECHANICAL PROPERTIES

Temperature range during installation	-5°C to +50°C
Temperature range stationary	-30°C to +70°C
Minimum bending radius	10 x diameter

Subject to changes due to technical progress and error



T.K. Kabel oHG · Geschwister-Scholl-Straße 11 · 71384 Weinstadt
Phone +49 (0) 7151/60 68 70 · Fax +49 (0) 7151/60 91 00 · info@tk-kabel.de · www.tk-kabel.de

JE-LIHCHSH Bd Si mtp* Fca

in resemblance to DIN VDE 0815

* capable of maxi-termi-point

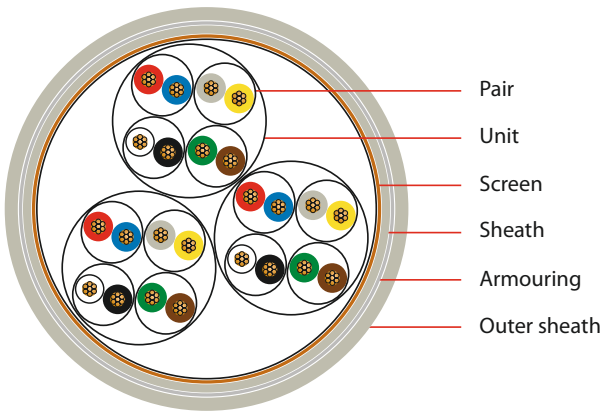

Dimension	Sheath thickness approx. mm	Diameter approx. mm	Cable weight approx. kg/km	Copper index kg/km
2 x 2 x 0.5	1.4	11.4	190	48
4 x 2 x 0.5	1.4	13.4	265	84
8 x 2 x 0.5	1.4	16.5	390	140
12 x 2 x 0.5	1.4	17.1	450	193
16 x 2 x 0.5	1.6	18.6	545	243
20 x 2 x 0.5	1.6	20.0	625	292
32 x 2 x 0.5	1.8	25.6	940	435
40 x 2 x 0.5	1.8	27.0	1070	531

APPLICATION

This halogen-free, flame-resistant cable is used where increased fire protection of persons, material goods and buildings is required. It serves for signal transmission in communication systems with fixed installation. Not approved for power installation. Due to water absorption the cable should only be laid directly in earth or water if a protective conduit is used.

CONSTRUCTION

Conductor: copper strand, bare; $7 \times 0.3 \text{ mm} = 0.5 \text{ mm}^2$ ($\varnothing 0.9 \text{ mm}$)

Core insulation: halogen-free compound

Core stranding: 2 cores to pair, 4 pairs to unit, units in layers; 2 x 2 as star quad

Lapping: plastic foil

Screen: tinned copper wire braid ($\varnothing 0.2 \text{ mm}$); optical coverage approx. 80 %

Sheath: halogen free compound

Armouring: galvanized steel wire braid ($\varnothing 0.24 \text{ mm}$); optical coverage approx. 80 %

Outer sheath: halogen-free compound; colour: pebble grey RAL 7032 or blue RAL 5015

BEHAVIOUR UNDER FIRE CONDITIONS

Zero halogen, non corrosive gases: IEC 60754-2, DIN EN 50267

Flame retardant: IEC 60332-1-2, DIN EN 60332-1-2

Fire retardant: IEC 60332-3-24, DIN EN 60332-3-24

Smoke density: IEC 61034, DIN EN 61034

ELECTRICAL CHARACTERISTICS

(Conductor) loop resistance max.	78.4 Ω /km
Insulation resistance min.	100 M Ω x km
Mutual capacitance (800 Hz) max.	120 nF/km 2 and 4 pair cable plus 20% permitted 1 pair 180nF/km
Capacitance unbalance (800 Hz) max.	200 pF/100m 20% of values, min. one value max. 400 pF
Test voltage core-core	500 V 50 Hz 1 min
Test voltage core-screen	2000 V 50 Hz 1 min
Peak operating voltage	225 V

THERMAL & MECHANICAL PROPERTIES

Temperature range during installation	-5°C to +50°C
Temperature range stationary	-30°C to +70°C
Minimum bending radius	10 x diameter

Subject to changes due to technical progress and error



T.K. Kabel oHG · Geschwister-Scholl-Straße 11 · 71384 Weinstadt
Phone +49 (0) 7151/60 68 70 · Fax +49 (0) 7151/60 91 00 · info@tk-kabel.de · www.tk-kabel.de

A-Y(St)Y Bd Si Fca

in resemblance to DIN VDE 0815

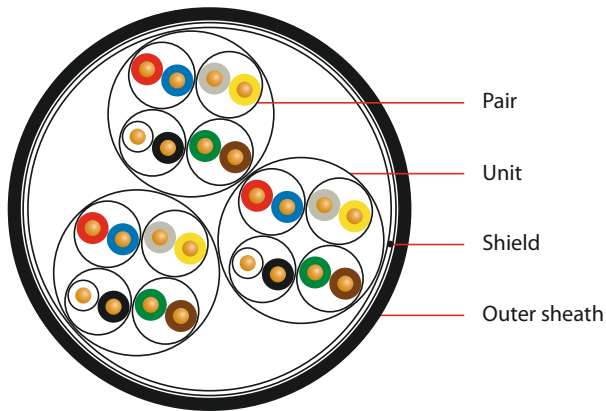

APPLICATION

For information transmission in dry and moist production sites, in and under plaster, as well as outdoors for fixed installation. Not approved for power installation, but appropriate for underground installation.

CONSTRUCTION

Conductor: copper, solid, bare (Ø 0.8 mm)

Core insulation: PVC

Core stranding: 2 cores to pair, 4 pairs to unit, units in layers; 2 x 2 as star quad

Lapping: plastic foil

Shield: tinned drain wire (Ø 0.8 mm); plastic-laminated aluminium foil

Outer sheath: PVC; colour: black RAL 9005 or blue RAL 5015 uv-resistant

ELECTRICAL CHARACTERISTICS

(Conductor) loop resistance max.	73.2 Ω/km
Insulation resistance min.	100 MΩ x km
Mutual capacitance (800 Hz) max.	100 nF/km 2 and 4 pair cable plus 20% permitted 1 pair 180nF/km
Capacitance unbalance (800 Hz) max.	200 pF/100m 20% of values, min one value up to 400 pF
Test voltage core-core	500 V 50 Hz 1 min
Test voltage core-screen	2000 V 50 Hz 1 min
Peak operating voltage	225 V

THERMAL & MECHANICAL PROPERTIES

Temperature range during installation	-5°C to +50°C
Temperature range stationary	-30°C to +70°C
Minimum bending radius	7.5 x diameter

Dimension	Sheath thickness approx. mm	Diameter approx. mm	Cable weight approx. kg/km	Copper index kg/km
2 x 2 x 0.8	1.8	7.5	86	25
4 x 2 x 0.8	1.8	10.0	130	45
8 x 2 x 0.8	1.8	12.5	200	85
12 x 2 x 0.8	1.8	14.0	270	126
16 x 2 x 0.8	1.8	15.5	335	166
20 x 2 x 0.8	1.8	16.0	395	206
24 x 2 x 0.8	1.8	18.0	432	246
28 x 2 x 0.8	1.8	18.5	520	287
32 x 2 x 0.8	1.8	20.0	600	327
36 x 2 x 0.8	1.8	20.5	695	367
40 x 2 x 0.8	1.8	22.0	725	407
48 x 2 x 0.8	1.8	24.1	765	488
60 x 2 x 0.8	2.0	27.0	1040	608
80 x 2 x 0.8	2.0	31.0	1360	809

Subject to changes due to technical progress and error



A-Y(St)YCY Bd Si Fca

in resemblance to DIN VDE 0815

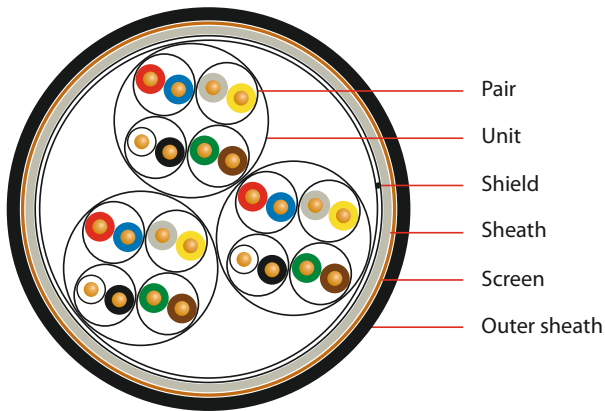

Dimension	Sheath thickness approx. mm	Diameter approx. mm	Cable weight approx. kg/km	Copper index kg/km
2 x 2 x 0.8	1.8	10.5	165	65
4 x 2 x 0.8	1.8	12.3	220	95
8 x 2 x 0.8	1.8	14.3	310	147
12 x 2 x 0.8	1.8	15.7	390	190
16 x 2 x 0.8	1.8	18.0	475	232
20 x 2 x 0.8	1.8	18.5	540	298
40 x 2 x 0.8	2.0	26.6	930	525

APPLICATION

For information transmission in dry and moist production sites, in and under plaster, as well as outdoors for fixed installation. Not approved for power installation, but appropriate for underground installation.

CONSTRUCTION

Conductor: copper, solid, bare (Ø 0.8 mm)

Core insulation: PVC

Core stranding: 2 cores to pair, 4 pairs to unit, units in layers; 2 x 2 as star quad

Lapping: plastic foil

Shield: tinned drain wire (Ø 0.8 mm); plastic-laminated aluminium foil

Sheath: PVC

Screen: tinned copper wire braid (Ø 0.2 mm); optical coverage approx. 80 %

Outer sheath: PVC; colour: black RAL 9005 or blue RAL 5015 uv-resistant

ELECTRICAL CHARACTERISTICS

(Conductor) loop resistance max.	73.2 Ω/km
Insulation resistance min.	100 MΩ x km
Mutual capacitance (800 Hz) max.	100 nF/km 2 and 4 pair cable plus 20% permitted 1 pair 180nF/km
Capacitance unbalance (800 Hz) max.	200 pF/100m 20% of values, min. one value max. 400 pF
Test voltage core-core	500 V 50 Hz 1 min
Test voltage core-screen	2000 V 50 Hz 1 min
Peak operating voltage	225 V

THERMAL & MECHANICAL PROPERTIES

Temperature range during installation	-5°C to +50°C
Temperature range stationary	-30°C to +70°C
Minimum bending radius	10 x diameter

Subject to changes due to technical progress and error



AJ-Y(St)YDY Bd Si Cu3.5 Fca

in resemblance to DIN VDE 0815

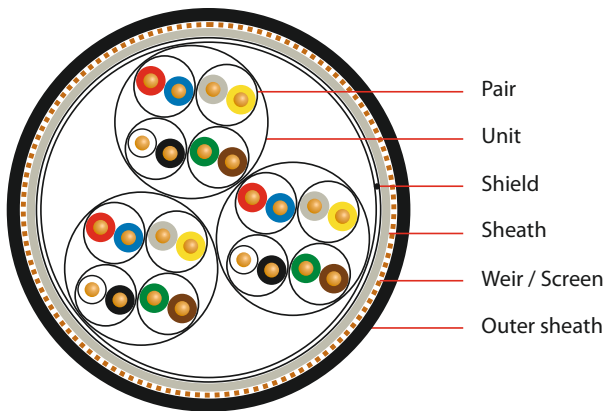

Dimension	Sheath thickness approx. mm	Diameter approx. mm	Cable weight approx. kg/km	Copper index kg/km
2 x 2 x 0.8	1.8	12.2	175	60
4 x 2 x 0.8	1.8	13.5	225	81
8 x 2 x 0.8	1.8	16.5	315	121
12 x 2 x 0.8	1.8	17.0	365	162
16 x 2 x 0.8	1.8	18.0	430	203
20 x 2 x 0.8	1.8	20.0	510	280
32 x 2 x 0.8	2.0	25.0	813	358
40 x 2 x 0.8	2.0	26.5	930	440

APPLICATION

For information transmission in dry and moist production sites, in and under plaster, as well as outdoors for fixed installation. Not approved for power installation, but appropriate for underground installation.

CONSTRUCTION

Conductor: copper, solid, bare (Ø 0.8 mm)

Core insulation: PVC

Core stranding: 2 cores to pair, 4 pairs to unit, units in layers; 2 x 2 as star quad

Lapping: plastic foil

Shield: tinned drain wire (Ø 0.8 mm); plastic-laminated aluminium foil

Sheath: PVC

Weir / Screen: cross section 3.5 mm²; surrounded with 7 bare copper wires (Ø 0.8 mm); lapping with plastic foil

Outer sheath: PVC; colour: black RAL 9005 or blue RAL 5015 uv-resistant

ELECTRICAL CHARACTERISTICS

(Conductor) loop resistance max.	73.2 Ω/km
Insulation resistance min.	100 MΩ x km
Mutual capacitance (800 Hz) max.	100 nF/km 2 and 4 pair cable plus 20% permitted 1 pair 180nF/km
Capacitance unbalance (800 Hz) max.	200 pF/100m 20% of values, min. one value max. 400 pF
Test voltage core-core	500 V 50 Hz 1 min
Test voltage core-screen	2000 V 50 Hz 1 min
Peak operating voltage	225 V

THERMAL & MECHANICAL PROPERTIES

Temperature range during installation	-5°C to +50°C
Temperature range stationary	-30°C to +70°C
Minimum bending radius	10 x diameter

Subject to changes due to technical progress and error



AJ-Y(St)YDY Bd Si Cu16 Fca

in resemblance to DIN VDE 0815

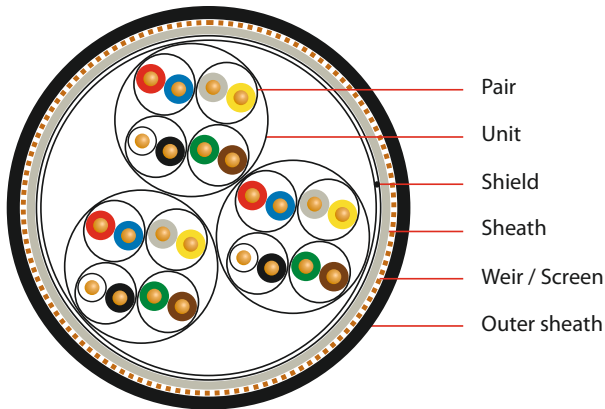

Dimension	Sheath thickness approx. mm	Diameter approx. mm	Cable weight approx. kg/km	Copper index kg/km
2 x 2 x 0.8	1.8	12.7	310	193
4 x 2 x 0.8	1.8	15.0	375	213
8 x 2 x 0.8	1.8	17.5	460	253
12 x 2 x 0.8	1.8	18.5	555	294
16 x 2 x 0.8	1.8	19.5	630	334
20 x 2 x 0.8	1.8	21.0	700	374
32 x 2 x 0.8	2.0	26.5	980	495
40 x 2 x 0.8	2.0	28.0	1100	575

APPLICATION

For information transmission in dry and moist production sites, in and under plaster, as well as outdoors for fixed installation. Not approved for power installation, but appropriate for underground installation.

CONSTRUCTION

Conductor: copper, solid, bare (Ø 0.8 mm)

Core insulation: PVC

Core stranding: 2 cores to pair, 4 pairs to unit, units in layers; 2 x 2 as star quad

Lapping: plastic foil

Shield: tinned drain wire (Ø 0.8 mm); plastic-laminated aluminium foil

Sheath: PVC

Weir / Screen: cross section 16 mm²; surrounded with 16 bare copper wires (Ø 1.13 mm); lapping with plastic foil

Outer sheath: PVC; colour: black RAL 9005 or blue RAL 5015 uv-resistant

ELECTRICAL CHARACTERISTICS

(Conductor) loop resistance max.	73.2 Ω/km
Insulation resistance min.	100 MΩ x km
Mutual capacitance (800 Hz) max.	100 nF/km 2 and 4 pair cable plus 20% permitted 1 pair 180nF/km
Capacitance unbalance (800 Hz) max.	200 pF/100m 20% of values, min. one value max. 400 pF
Test voltage core-core	500 V 50 Hz 1 min
Test voltage core-screen	2000 V 50 Hz 1 min
Peak operating voltage	225 V

THERMAL & MECHANICAL PROPERTIES

Temperature range during installation	-5°C to +50°C
Temperature range stationary	-30°C to +70°C
Minimum bending radius	10 x diameter

Subject to changes due to technical progress and error



A-Y(St)YSY Bd Si Fca

in resemblance to DIN VDE 0815

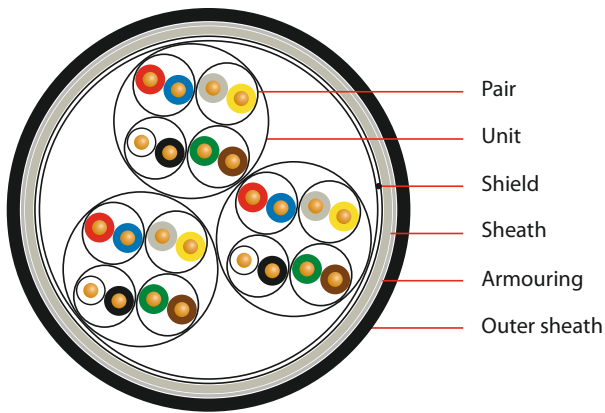

Dimension	Sheath thickness approx. mm	Diameter approx. mm	Cable weight approx. kg/km	Copper index kg/km
1 x 2 x 0.8	1.8	10.4	134	15
2 x 2 x 0.8	1.8	11.0	160	25
4 x 2 x 0.8	1.8	12.5	216	45
8 x 2 x 0.8	1.8	15.5	320	85
12 x 2 x 0.8	1.8	16.0	386	126
16 x 2 x 0.8	1.8	17.0	450	166
20 x 2 x 0.8	1.8	19.0	540	206
32 x 2 x 0.8	2.0	24.0	850	327
40 x 2 x 0.8	2.0	26.0	960	407

APPLICATION

For information transmission in dry and moist production sites, in and under plaster, as well as outdoors for fixed installation. Not approved for power installation, but appropriate for underground installation.

CONSTRUCTION

Conductor: copper, solid, bare (Ø 0.8 mm)

Core insulation: PVC

Core stranding: 2 cores to pair, 4 pairs to unit, units in layers; 2 x 2 as star quad

Lapping: plastic foil

Shield: tinned drain wire (Ø 0.8 mm); plastic-laminated aluminium foil

Sheath: PVC

Armouring: galvanized steel wire braid (Ø 0.24 mm); optical coverage approx. 80 %

Outer sheath: PVC; colour: black RAL 9005 or blue RAL 5015 uv-resistant

ELECTRICAL CHARACTERISTICS

(Conductor) loop resistance max.	73.2 Ω/km
Insulation resistance min.	100 MΩ x km
Mutual capacitance (800 Hz) max.	100 nF/km 2 and 4 pair cable plus 20% permitted 1 pair 180nF/km
Capacitance unbalance (800 Hz) max.	200 pF/100m 20% of values, min. one value max. 400 pF
Test voltage core-core	500 V 50 Hz 1 min
Test voltage core-screen	2000 V 50 Hz 1 min
Peak operating voltage	225 V

THERMAL & MECHANICAL PROPERTIES

Temperature range during installation	-5°C to +50°C
Temperature range stationary	-30°C to +70°C
Minimum bending radius	10 x diameter

Subject to changes due to technical progress and error



A-LIYCY Bd Si Fca

in resemblance to DIN VDE 0815

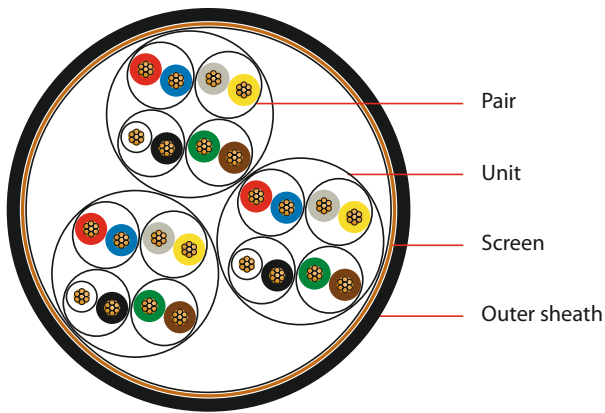

Dimension	Sheath thickness approx. mm	Diameter approx. mm	Cable weight approx. kg/km	Copper index kg/km
2 x 2 x 0.5	1.8	8.3	110	48
4 x 2 x 0.5	1.8	10.5	150	84
8 x 2 x 0.5	1.8	13.3	240	140
12 x 2 x 0.5	1.8	14.0	300	193
16 x 2 x 0.5	1.8	15.2	360	243
20 x 2 x 0.5	1.8	16.5	425	292
32 x 2 x 0.5	1.8	21.5	640	435
40 x 2 x 0.5	1.8	23.0	750	531

APPLICATION

For information transmission in dry and moist production sites, in and under plaster, as well as outdoors for fixed installation. Not approved for power installation, but appropriate for underground installation.

CONSTRUCTION

Conductor: copper strand, bare; $7 \times 0.3 \text{ mm} = 0.5 \text{ mm}^2$ ($\varnothing 0.9 \text{ mm}$)

Core insulation: PVC

Core stranding: 2 cores to pair, 4 pairs to unit, units in layers; 2 x 2 as star quad

Lapping: plastic foil

Screen: tinned copper wire braid ($\varnothing 0.2 \text{ mm}$); optical coverage approx. 80 %

Outer sheath: PVC; colour: black RAL 9005 or blue RAL 5015 uv-resistant

ELECTRICAL CHARACTERISTICS

(Conductor) loop resistance max.	78.4 Ω /km
Insulation resistance min.	100 M Ω x km
Mutual capacitance (800 Hz) max.	100 nF/km 2 and 4 pair cable plus 20% permitted 1 pair 180nF/km
Capacitance unbalance (800 Hz) max.	200 pF/100m 20% of values, min. one value max. 400 pF
Test voltage core-core	500 V 50 Hz 1 min
Test voltage core-screen	2000 V 50 Hz 1 min
Peak operating voltage	225 V

THERMAL & MECHANICAL PROPERTIES

Temperature range during installation	-5°C to +50°C
Temperature range stationary	-30°C to +70°C
Minimum bending radius	7.5 x diameter

Subject to changes due to technical progress and error



A-Y(St)Y-FR Bd Si Fca

in resemblance to DIN VDE 0815

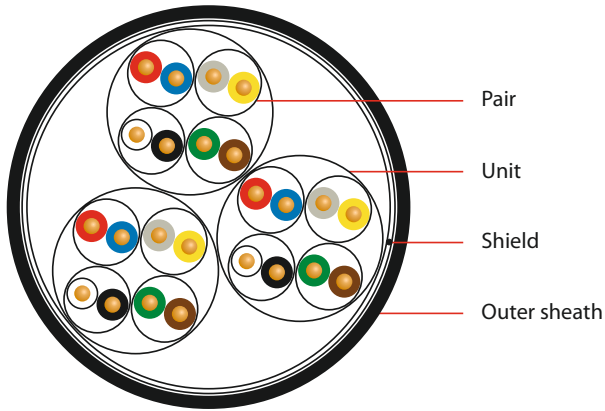

APPLICATION

For information transmission in dry and moist production sites, in and under plaster, as well as outdoors for fixed installation. Not approved for power installation, but appropriate for underground installation.

CONSTRUCTION

- Conductor:** copper, solid, bare (Ø 0.8 mm)
- Core insulation:** PVC
- Core stranding:** 2 cores to pair, 4 pairs to unit, units in layers; 2 x 2 as star quad
- Lapping:** plastic foil
- Shield:** tinned drain wire (Ø 0.8 mm); plastic-laminated aluminium foil
- Outer sheath:** PVC-FR; colour: black RAL 9005 or blue RAL 5015 uv-resistant

BEHAVIOUR UNDER FIRE CONDITIONS

Fire retardant: IEC 60332-3-24, DIN EN 60332-3-24
Low smoke and fume

ELECTRICAL CHARACTERISTICS

(Conductor) loop resistance max.	73.2 Ω/km
Insulation resistance min.	100 MΩ x km
Mutual capacitance (800 Hz) max.	100 nF/km <small>2 and 4 pair cable plus 20% permitted 1 pair 180nF/km</small>
Capacitance unbalance (800 Hz) max.	200 pF/100m <small>20% of values, min. one value max. 400 pF</small>
Test voltage core-core	500 V 50 Hz 1 min
Test voltage core-screen	2000 V 50 Hz 1 min
Peak operating voltage	225 V

THERMAL & MECHANICAL PROPERTIES

Temperature range during installation	-5°C to +50°C
Temperature range stationary	-30°C to +70°C
Minimum bending radius	7.5 x diameter

Dimension	Sheath thickness approx. mm	Diameter approx. mm	Cable weight approx. kg/km	Copper index kg/km
2 x 2 x 0.8	1.8	7.5	86	25
4 x 2 x 0.8	1.8	10.0	130	45
8 x 2 x 0.8	1.8	12.5	200	85
12 x 2 x 0.8	1.8	14.0	270	126
16 x 2 x 0.8	1.8	15.5	335	166
20 x 2 x 0.8	1.8	16.0	395	206
24 x 2 x 0.8	1.8	18.0	432	246
28 x 2 x 0.8	1.8	18.5	520	287
32 x 2 x 0.8	1.8	20.0	600	327
36 x 2 x 0.8	1.8	20.5	695	367
40 x 2 x 0.8	1.8	22.0	725	407
48 x 2 x 0.8	1.8	24.1	765	488
60 x 2 x 0.8	2.0	27.0	1040	608
80 x 2 x 0.8	2.0	31.0	1360	809

Subject to changes due to technical progress and error



A-Y(St)YCY-FR Bd Si Fca

in resemblance to DIN VDE 0815

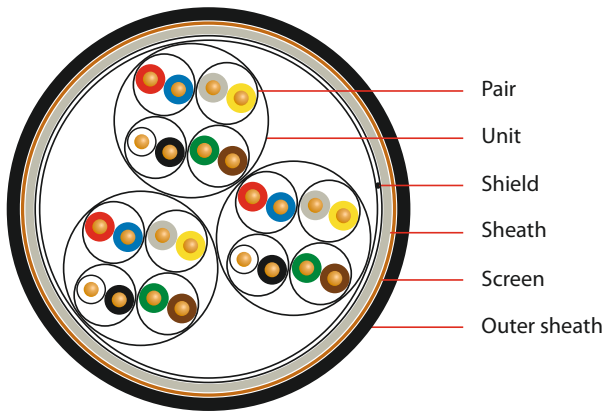

APPLICATION

For information transmission in dry and moist production sites, in and under plaster, as well as outdoors for fixed installation. Not approved for power installation, but appropriate for underground installation.

CONSTRUCTION

Conductor: copper, solid, bare (\varnothing 0.8 mm)

Core insulation: PVC

Core stranding: 2 cores to pair, 4 pairs to unit, units in layers; 2 x 2 as star quad

Lapping: plastic foil

Shield: tinned drain wire (\varnothing 0.8 mm); plastic-laminated aluminium foil

Sheath: PVC

Screen: tinned copper wire braid (\varnothing 0.2 mm); optical coverage approx. 80 %

Outer sheath: PVC-FR;

colour: black RAL 9005 or blue RAL 5015 uv-resistant

BEHAVIOUR UNDER FIRE CONDITIONS

Fire retardant: IEC 60332-3-24, DIN EN 60332-3-24

Low smoke and fume

Dimension	Sheath thickness approx. mm	Diameter approx. mm	Cable weight approx. kg/km	Copper index kg/km
(Cu3.5) 1 x 2 x 0.8	1.8	10.7	160	58
(Cu3.5) 2 x 2 x 0.8	1.8	11.5	185	72
2 x 2 x 0.8	1.8	10.5	165	65
4 x 2 x 0.8	1.8	12.3	220	95
8 x 2 x 0.8	1.8	14.3	310	147
12 x 2 x 0.8	1.8	15.7	390	190
16 x 2 x 0.8	1.8	18.0	475	232
20 x 2 x 0.8	1.8	18.5	540	298
32 x 2 x 0.8	2.0	23.2	745	448
40 x 2 x 0.8	2.0	26.6	930	525

ELECTRICAL CHARACTERISTICS

(Conductor) loop resistance max.	73.2 Ω /km
Insulation resistance min.	100 M Ω x km
Mutual capacitance (800 Hz) max.	100 nF/km 2 and 4 pair cable plus 20% permitted 1 pair 180nF/km
Capacitance unbalance (800 Hz) max.	200 pF/100m 20% of values, min. one value max. 400 pF
Test voltage core-core	500 V 50 Hz 1 min
Test voltage core-screen	2000 V 50 Hz 1 min
Peak operating voltage	225 V

THERMAL & MECHANICAL PROPERTIES

Temperature range during installation	-5°C to +50°C
Temperature range stationary	-30°C to +70°C
Minimum bending radius	10 x diameter

Subject to changes due to technical progress and error



T.K. Kabel oHG · Geschwister-Scholl-Straße 11 · 71384 Weinstadt

Phone +49 (0) 7151/60 68 70 · Fax +49 (0) 7151/60 91 00 · info@tk-kabel.de · www.tk-kabel.de

AJ-Y(St)YDY-FR Bd Si Cu3.5 Fca

in resemblance to DIN VDE 0815

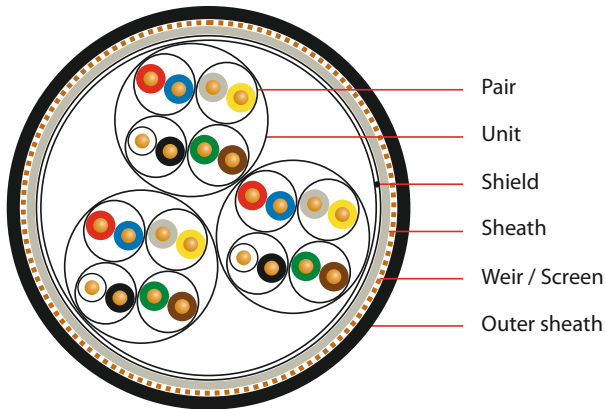

Dimension	Sheath thickness approx. mm	Diameter approx. mm	Cable weight approx. kg/km	Copper index kg/km
2 x 2 x 0.8	1.8	12.2	175	60
4 x 2 x 0.8	1.8	13.5	225	81
8 x 2 x 0.8	1.8	16.5	315	121
12 x 2 x 0.8	1.8	17.0	365	162
16 x 2 x 0.8	1.8	18.0	430	203
20 x 2 x 0.8	1.8	20.0	510	280
32 x 2 x 0.8	2.0	25.0	813	358
40 x 2 x 0.8	2.0	26.5	930	440

APPLICATION

For information transmission in dry and moist production sites, in and under plaster, as well as outdoors for fixed installation. Not approved for power installation, but appropriate for underground installation.

CONSTRUCTION

Conductor: copper, solid, bare (Ø 0.8 mm)

Core insulation: PVC

Core stranding: 2 cores to pair, 4 pairs to unit, units in layers; 2 x 2 as star quad

Lapping: plastic foil

Shield: tinned drain wire (Ø 0.8 mm); plastic-laminated aluminium foil

Sheath: PVC

Weir / Screen: cross section 3.5 mm²; surrounded with 7 bare copper wires (Ø 0.8 mm); lapping with plastic foil

Outer sheath: PVC-FR; colour: black RAL 9005 or blue RAL 5015 uv-resistant

BEHAVIOUR UNDER FIRE CONDITIONS

Fire retardant: IEC 60332-3-24, DIN EN 60332-3-24

Low smoke and fume

ELECTRICAL CHARACTERISTICS

(Conductor) loop resistance max.	73.2 Ω/km
Insulation resistance min.	100 MΩ x km
Mutual capacitance (800 Hz) max.	100 nF/km 2 and 4 pair cable plus 20% permitted 1 pair 180nF/km
Capacitance unbalance (800 Hz) max.	200 pF/100m 20% of values, min. one value max. 400 pF
Test voltage core-core	500 V 50 Hz 1 min
Test voltage core-screen	2000 V 50 Hz 1 min
Peak operating voltage	225 V

THERMAL & MECHANICAL PROPERTIES

Temperature range during installation	-5°C to +50°C
Temperature range stationary	-30°C to +70°C
Minimum bending radius	10 x diameter

Subject to changes due to technical progress and error



AJ-Y(St)YDY-FR Bd Si Cu16 Fca

in resemblance to DIN VDE 0815

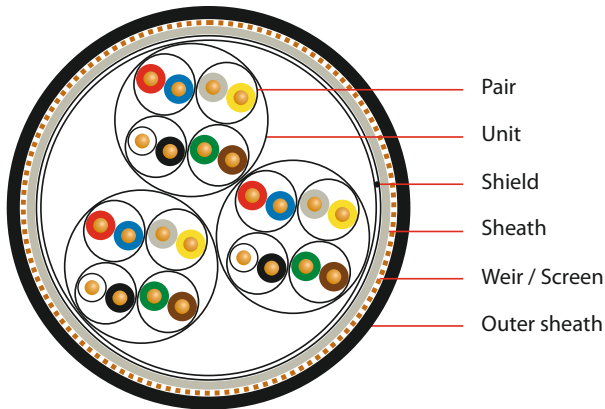

APPLICATION

For information transmission in dry and moist production sites, in and under plaster, as well as outdoors for fixed installation. Not approved for power installation, but appropriate for underground installation.

CONSTRUCTION

Conductor: copper, solid, bare (Ø 0.8 mm)

Core insulation: PVC

Core stranding: 2 cores to pair, 4 pairs to unit, units in layers; 2 x 2 as star quad

Lapping: plastic foil

Shield: tinned drain wire (Ø 0.8 mm); plastic-laminated aluminium foil

Sheath: PVC

Weir / Screen: cross section 16 mm²; surrounded with 16 bare copper wires (Ø 1.13 mm); lapping with plastic foil

Outer sheath: PVC-FR;

colour: black RAL 9005 or blue RAL 5015 uv-resistant

BEHAVIOUR UNDER FIRE CONDITIONS

Fire retardant: IEC 60332-3-24, DIN EN 60332-3-24

Low smoke and fume

Dimension	Sheath thickness approx. mm	Diameter approx. mm	Cable weight approx. kg/km	Copper index kg/km
2 x 2 x 0.8	1.8	12.7	310	193
4 x 2 x 0.8	1.8	15.0	375	213
8 x 2 x 0.8	1.8	17.5	460	253
12 x 2 x 0.8	1.8	18.5	555	294
16 x 2 x 0.8	1.8	19.5	630	334
20 x 2 x 0.8	1.8	21.0	700	374
32 x 2 x 0.8	2.0	26.5	980	495
40 x 2 x 0.8	2.0	28.0	1100	575

ELECTRICAL CHARACTERISTICS

(Conductor) loop resistance max.	73.2 Ω/km
Insulation resistance min.	100 MΩ x km
Mutual capacitance (800 Hz) max.	100 nF/km 2 and 4 pair cable plus 20% permitted 1 pair 180nF/km
Capacitance unbalance (800 Hz) max.	200 pF/100m 20% of values, min. one value max. 400 pF
Test voltage core-core	500 V 50 Hz 1 min
Test voltage core-screen	2000 V 50 Hz 1 min
Peak operating voltage	225 V

THERMAL & MECHANICAL PROPERTIES

Temperature range during installation	-5°C to +50°C
Temperature range stationary	-30°C to +70°C
Minimum bending radius	10 x diameter

Subject to changes due to technical progress and error



AJ-Y(St)YCYDY-FR Bd Si Cu16 Fca

in resemblance to DIN VDE 0815

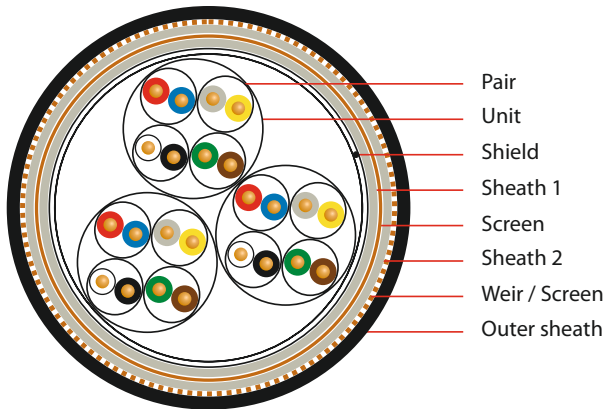

APPLICATION

For information transmission in dry and moist production sites, in and under plaster, as well as outdoors for fixed installation. Not approved for power installation, but appropriate for underground installation.

CONSTRUCTION

Conductor: copper, solid, bare (Ø 0.8 mm)

Core insulation: PVC

Core stranding: 2 cores to pair, 4 pairs to unit, units in layers; 2 x 2 as star quad

Lapping: plastic foil

Shield: tinned drain wire (Ø 0.8 mm); plastic-laminated aluminium foil

Sheath 1: PVC

Lapping: plastic foil

Screen: tinned copper wire braid (Ø 0.2 mm); optical coverage approx. 80 %

Sheath 2: PVC

Weir / Screen: cross section 16 mm²; surrounded with 16 bare copper wires (Ø 1.13 mm); lapping with plastic foil

Outer sheath: PVC-FR;

colour: black RAL 9005 or blue RAL 5015 uv-resistant

BEHAVIOUR UNDER FIRE CONDITIONS

Fire retardant: IEC 60332-3-24, DIN EN 60332-3-24

Low smoke and fume

Dimension	Sheath thickness approx. mm	Diameter approx. mm	Cable weight approx. kg/km	Copper index kg/km
2 x 2 x 0.8	1.8	16.1	410	233
4 x 2 x 0.8	1.8	17.8	475	266
8 x 2 x 0.8	1.8	20.0	575	324
12 x 2 x 0.8	1.8	20.9	650	369
16 x 2 x 0.8	1.8	22.1	725	413
20 x 2 x 0.8	1.8	23.6	820	472
32 x 2 x 0.8	2.0	28.0	1110	622
40 x 2 x 0.8	2.0	30.0	1270	721

ELECTRICAL CHARACTERISTICS

(Conductor) loop resistance max.	73.2 Ω/km
Insulation resistance min.	100 MΩ x km
Mutual capacitance (800 Hz) max.	100 nF/km 2 and 4 pair cable plus 20% permitted 1 pair 180nF/km
Capacitance unbalance (800 Hz) max.	200 pF/100m 20% of values, min. one value max. 400 pF
Test voltage core-core	500 V 50 Hz 1 min
Test voltage core-screen	2000 V 50 Hz 1 min
Test voltage shield-screen	2000 V 50 Hz 1 min
Peak operating voltage	225 V

THERMAL & MECHANICAL PROPERTIES

Temperature range during installation	-5°C to +50°C
Temperature range stationary	-30°C to +70°C
Minimum bending radius	10 x diameter

Subject to changes due to technical progress and error



A-Y(St)YSY-FR Bd Si Fca

in resemblance to DIN VDE 0815

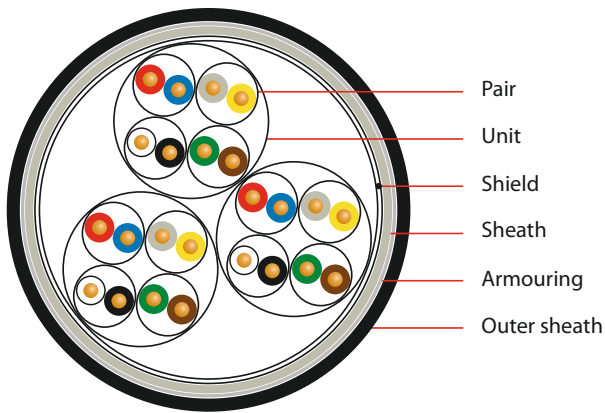

Dimension	Sheath thickness approx. mm	Diameter approx. mm	Cable weight approx. kg/km	Copper index kg/km
1 x 2 x 0.8	1.8	10.4	134	15
2 x 2 x 0.8	1.8	11.0	160	25
4 x 2 x 0.8	1.8	12.5	216	45
8 x 2 x 0.8	1.8	15.5	320	85
12 x 2 x 0.8	1.8	16.0	386	126
16 x 2 x 0.8	1.8	17.0	450	166
20 x 2 x 0.8	1.8	19.0	540	206
32 x 2 x 0.8	2.0	24.0	850	327
40 x 2 x 0.8	2.0	26.0	960	407

APPLICATION

For information transmission in dry and moist production sites, in and under plaster, as well as outdoors for fixed installation. Not approved for power installation, but appropriate for underground installation.

CONSTRUCTION

Conductor: copper, solid, bare (Ø 0.8 mm)

Core insulation: PVC

Core stranding: 2 cores to pair, 4 pairs to unit, units in layers; 2 x 2 as star quad

Lapping: plastic foil

Shield: tinned drain wire (Ø 0.8 mm); plastic-laminated aluminium foil

Sheath: PVC

Armouring: galvanized steel wire braid (Ø 0.24 mm); optical coverage approx. 80 %

Outer sheath: PVC-FR;

colour: black RAL 9005 or blue RAL 5015 uv-resistant

BEHAVIOUR UNDER FIRE CONDITIONS

Fire retardant: IEC 60332-3-24, DIN EN 60332-3-24

Low smoke and fume

ELECTRICAL CHARACTERISTICS

(Conductor) loop resistance max.	73.2 Ω/km
Insulation resistance min.	100 MΩ x km
Mutual capacitance (800 Hz) max.	100 nF/km 2 and 4 pair cable plus 20% permitted 1 pair 180nF/km
Capacitance unbalance (800 Hz) max.	200 pF/100m 20% of values, min. one value max. 400 pF
Test voltage core-core	500 V 50 Hz 1 min
Test voltage core-screen	2000 V 50 Hz 1 min
Peak operating voltage	225 V

THERMAL & MECHANICAL PROPERTIES

Temperature range during installation	-5°C to +50°C
Temperature range stationary	-30°C to +70°C
Minimum bending radius	10 x diameter

Subject to changes due to technical progress and error



A-Y(St)YSYö-FR Bd Si Fca

in resemblance to DIN VDE 0815

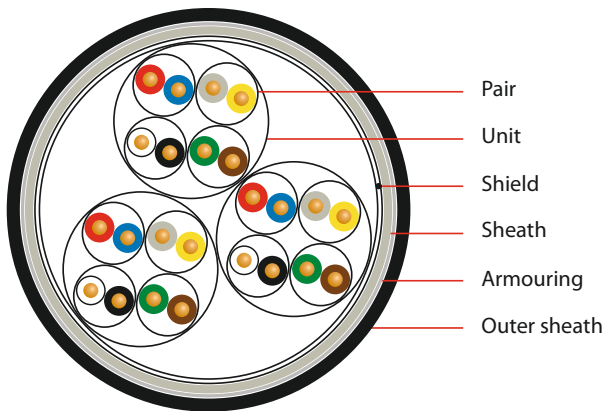

APPLICATION

For information transmission in dry and moist production sites, in and under plaster, as well as outdoors for fixed installation. Not approved for power installation, but appropriate for underground installation. Resistant to impact of oils.

CONSTRUCTION

Conductor: copper, solid, bare (Ø 0.8 mm)

Core insulation: PVC

Core stranding: 2 cores to pair, 4 pairs to unit, units in layers; 2 x 2 as star quad

Lapping: plastic foil

Shield: tinned drain wire (Ø 0.8 mm); plastic-laminated aluminium foil

Sheath: PVC

Armouring: galvanized steel wire braid (Ø 0.24 mm); optical coverage approx. 80 %

Outer sheath: PVC-FR; oil-resistant acc. DIN EN 60811-404, VDE 0473-811-404 edition 2012; colour: black RAL 9005

BEHAVIOUR UNDER FIRE CONDITIONS

Fire retardant: IEC 60332-3-24, DIN EN 60332-3-24

Low smoke and fume

Dimension	Sheath thickness approx. mm	Diameter approx. mm	Cable weight approx. kg/km	Copper index kg/km
1 x 2 x 0.8	1.8	10.4	134	15
2 x 2 x 0.8	1.8	11.0	160	25
4 x 2 x 0.8	1.8	12.5	216	45
8 x 2 x 0.8	1.8	15.5	320	85
12 x 2 x 0.8	1.8	16.0	386	126
16 x 2 x 0.8	1.8	17.0	450	166
20 x 2 x 0.8	1.8	19.0	540	206
32 x 2 x 0.8	2.0	24.0	850	327
40 x 2 x 0.8	2.0	26.0	960	407

ELECTRICAL CHARACTERISTICS

(Conductor) loop resistance max.	73.2 Ω/km
Insulation resistance min.	100 MΩ x km
Mutual capacitance (800 Hz) max.	100 nF/km 2 and 4 pair cable plus 20% permitted 1 pair 180nF/km
Capacitance unbalance (800 Hz) max.	200 pF/100m 20% of values, min. one value max. 400 pF
Test voltage core-core	500 V 50 Hz 1 min
Test voltage core-screen	2000 V 50 Hz 1 min
Peak operating voltage	225 V

THERMAL & MECHANICAL PROPERTIES

Temperature range during installation	-5°C to +50°C
Temperature range stationary	-30°C to +70°C
Minimum bending radius	10 x diameter

Subject to changes due to technical progress and error



T.K. Kabel oHG · Geschwister-Scholl-Straße 11 · 71384 Weinstadt

Phone +49 (0) 7151/60 68 70 · Fax +49 (0) 7151/60 91 00 · info@tk-kabel.de · www.tk-kabel.de

A-LIYCY-FR Bd Si Fca

in resemblance to DIN VDE 0815

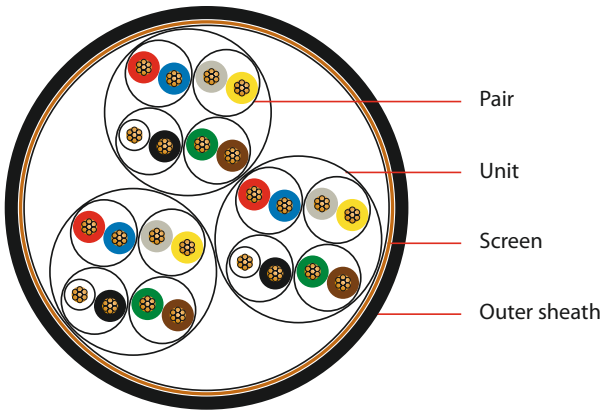

APPLICATION

For information transmission in dry and moist production sites, in and under plaster, as well as outdoors for fixed installation. Not approved for power installation, but appropriate for underground installation.

CONSTRUCTION

Conductor: copper strand, bare; $7 \times 0.3 \text{ mm} = 0.5 \text{ mm}^2$ ($\varnothing 0.9 \text{ mm}$)

Core insulation: PVC

Core stranding: 2 cores to pair, 4 pairs to unit, units in layers; 2 x 2 as star quad

Lapping: plastic foil

Screen: tinned copper wire braid ($\varnothing 0.2 \text{ mm}$); optical coverage approx. 80 %

Outer sheath: PVC-FR; colour: black RAL 9005 or blue RAL 5015 uv-resistant

BEHAVIOUR UNDER FIRE CONDITIONS

Fire retardant: IEC 60332-3-24, DIN EN 60332-3-24

Low smoke and fume

Dimension	Sheath thickness approx. mm	Diameter approx. mm	Cable weight approx. kg/km	Copper index kg/km
2 x 2 x 0.5	1.8	8.3	110	48
4 x 2 x 0.5	1.8	10.5	150	84
8 x 2 x 0.5	1.8	13.3	240	140
12 x 2 x 0.5	1.8	14.0	300	193
16 x 2 x 0.5	1.8	15.2	360	243
20 x 2 x 0.5	1.8	16.5	425	292
32 x 2 x 0.5	1.8	21.5	640	435
40 x 2 x 0.5	1.8	23.0	750	531

ELECTRICAL CHARACTERISTICS

(Conductor) loop resistance max.	78.4 Ω /km
Insulation resistance min.	100 M Ω x km
Mutual capacitance (800 Hz) max.	100 nF/km 2 and 4 pair cable plus 20% permitted 1 pair 180nF/km
Capacitance unbalance (800 Hz) max.	200 pF/100m 20% of values, min. one value max. 400 pF
Test voltage core-core	500 V 50 Hz 1 min
Test voltage core-screen	2000 V 50 Hz 1 min
Peak operating voltage	225 V

THERMAL & MECHANICAL PROPERTIES

Temperature range during installation	-5°C to +50°C
Temperature range stationary	-30°C to +70°C
Minimum bending radius	7.5 x diameter

Subject to changes due to technical progress and error



A-LIYCYSY-FR Bd Si Fca

in resemblance to DIN VDE 0815

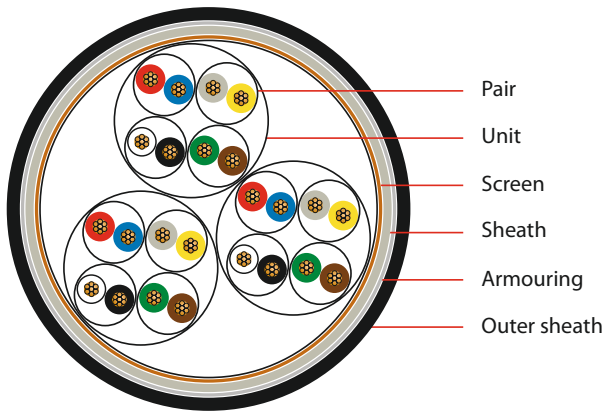

Dimension	Sheath thickness approx. mm	Diameter approx. mm	Cable weight approx. kg/km	Copper index kg/km
2 x 2 x 0.5	1.8	11.5	195	48
4 x 2 x 0.5	1.8	13.5	265	84
8 x 2 x 0.5	1.8	16.6	390	140
12 x 2 x 0.5	1.8	17.6	470	193
16 x 2 x 0.5	1.8	18.7	550	243
20 x 2 x 0.5	1.8	20.0	625	292
32 x 2 x 0.5	1.8	26.1	975	435
40 x 2 x 0.5	2.0	27.6	1125	531

APPLICATION

For information transmission in dry and moist production sites, in and under plaster, as well as outdoors for fixed installation. Not approved for power installation, but appropriate for underground installation.

CONSTRUCTION

Conductor: copper strand, bare; $7 \times 0.3 \text{ mm} = 0.5 \text{ mm}^2$ ($\varnothing 0.9 \text{ mm}$)

Core insulation: PVC

Core stranding: 2 cores to pair, 4 pairs to unit, units in layers; 2 x 2 as star quad

Lapping: plastic foil

Screen: tinned copper wire braid ($\varnothing 0.2 \text{ mm}$); optical coverage approx. 80 %

Sheath: PVC

Armouring: galvanized steel wire braid ($\varnothing 0.24 \text{ mm}$); optical coverage approx. 80 %

Outer sheath: PVC-FR;

colour: black RAL 9005 or blue RAL 5015 uv-resistant

BEHAVIOUR UNDER FIRE CONDITIONS

Fire retardant: IEC 60332-3-24, DIN EN 60332-3-24

Low smoke and fume

ELECTRICAL CHARACTERISTICS

(Conductor) loop resistance max.	78.4 Ω /km
Insulation resistance min.	100 M Ω x km
Mutual capacitance (800 Hz) max.	100 nF/km 2 and 4 pair cable plus 20% permitted 1 pair 180nF/km
Capacitance unbalance (800 Hz) max.	200 pF/100m 20% of values, min. one value max. 400 pF
Test voltage core-core	500 V 50 Hz 1 min
Test voltage core-screen	2000 V 50 Hz 1 min
Peak operating voltage	225 V

THERMAL & MECHANICAL PROPERTIES

Temperature range during installation	-5°C to +50°C
Temperature range stationary	-30°C to +70°C
Minimum bending radius	10 x diameter

Subject to changes due to technical progress and error



AJ-LIYCYDY-FR Bd Si Cu3.5 Fca

in resemblance to DIN VDE 0815

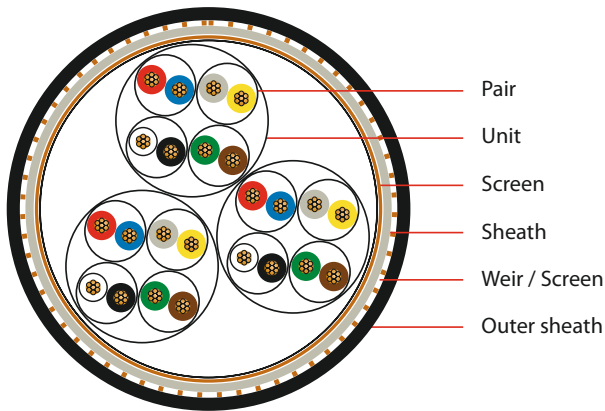

APPLICATION

For information transmission in dry and moist production sites, in and under plaster, as well as outdoors for fixed installation. Not approved for power installation, but appropriate for underground installation.

CONSTRUCTION

Conductor: copper strand, bare; $7 \times 0.3 \text{ mm} = 0.5 \text{ mm}^2$ ($\varnothing 0.9 \text{ mm}$)

Core insulation: PVC

Core stranding: 2 cores to pair, 4 pairs to unit, units in layers; 2 x 2 as star quad

Lapping: plastic foil

Screen: tinned copper wire braid ($\varnothing 0.2 \text{ mm}$); optical coverage approx. 80 %

Sheath: PVC

Weir / Screen: cross section 3.5 mm^2 ; surrounded with 7 bare copper wires ($\varnothing 0.08 \text{ mm}$); lapping with plastic foil

Outer sheath: PVC-FR;

colour: black RAL 9005 or blue RAL 5015 uv-resistant

BEHAVIOUR UNDER FIRE CONDITIONS

Fire retardant: IEC 60332-3-24, DIN EN 60332-3-24

Low smoke and fume

Dimension	Sheath thickness approx. mm	Diameter approx. mm	Cable weight approx. kg/km	Copper index kg/km
1 x 2 x 0.5	1.8	12.0	180	79
2 x 2 x 0.5	1.8	13.0	200	84
4 x 2 x 0.5	1.8	15.0	240	121
8 x 2 x 0.5	1.8	18.0	365	178
12 x 2 x 0.5	1.8	18.5	425	232
16 x 2 x 0.5	1.8	20.5	510	283
20 x 2 x 0.5	1.8	22.0	580	333
32 x 2 x 0.5	2.0	27.0	870	478
40 x 2 x 0.5	2.0	28.5	1000	576

ELECTRICAL CHARACTERISTICS

(Conductor) loop resistance max.	78.4 Ω /km
Insulation resistance min.	100 M Ω x km
Mutual capacitance (800 Hz) max.	100 nF/km 2 and 4 pair cable plus 20% permitted 1 pair 180nF/km
Capacitance unbalance (800 Hz) max.	200 pF/100m 20% of values, min. one value max. 400 pF
Test voltage core-core	500 V 50 Hz 1 min
Test voltage core-screen	2000 V 50 Hz 1 min
Peak operating voltage	225 V

THERMAL & MECHANICAL PROPERTIES

Temperature range during installation	-5°C to +50°C
Temperature range stationary	-30°C to +70°C
Minimum bending radius	15 x diameter

Subject to changes due to technical progress and error



A-LIY(St)YSY-FR PimF Bd Si Fca

in resemblance to DIN VDE 0815

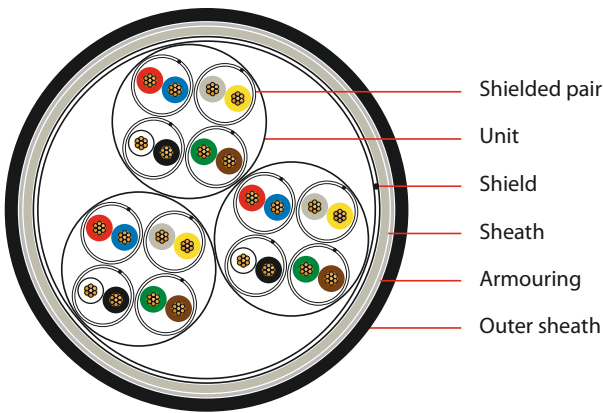

Dimension	Sheath thickness approx. mm	Diameter approx. mm	Cable weight approx. kg/km	Copper index kg/km
2 x 2 x 0.5	1.8	13.0	215	28
4 x 2 x 0.5	1.8	13.6	260	50
8 x 2 x 0.5	1.8	18.7	422	96
12 x 2 x 0.5	1.8	19.6	500	141
16 x 2 x 0.5	1.8	21.0	575	186
20 x 2 x 0.5	1.8	22.6	700	233

APPLICATION

For information transmission in dry and moist production sites, in and under plaster, as well as outdoors for fixed installation. Not approved for power installation, but appropriate for underground installation.

CONSTRUCTION

Conductor: copper strand, bare; 7 x 0.3 mm = 0.5 mm² (Ø 0.9 mm)

Core insulation: PVC

Shielded pairs: each pair one layer plastic tape;
 drain wire: tinned copper strand 7 x 0.16 mm;
 one layer plastic laminated aluminium foil

Core stranding: 2 cores to pair, 4 pairs to unit, units in layers;
 2 x 2 as star quad

Lapping: plastic foil

Shield: tinned drain wire (Ø 0.8 mm); plastic-laminated aluminium foil

Sheath: PVC

Armouring: galvanized steel wire braid (Ø 0.24 mm);
 optical coverage approx. 80 %

Outer sheath: PVC-FR;

colour: black RAL 9005 or blue RAL 5015 uv-resistant

BEHAVIOUR UNDER FIRE CONDITIONS

Fire retardant: IEC 60332-3-24, DIN EN 60332-3-24

Low smoke and fume

ELECTRICAL CHARACTERISTICS

(Conductor) loop resistance max.	78.4 Ω/km
Insulation resistance min.	100 MΩ x km
Mutual capacitance (800 Hz) max.	180 nF/km
Capacitance unbalance (800 Hz) max.	200 pF/100m <small>20% of values, min. one value max. 400 pF</small>
Test voltage core-core	1000 V 50 Hz 2 min
Test voltage core-screen	2000 V 50 Hz 2 min
Peak operating voltage	225 V

THERMAL & MECHANICAL PROPERTIES

Temperature range during installation	-5°C to +50°C
Temperature range stationary	-30°C to +70°C
Minimum bending radius	15 x diameter

Subject to changes due to technical progress and error



A-H(St)HCH Bd Si mtp* Fca

in resemblance to DIN VDE 0815

* capable of maxi-termi-point

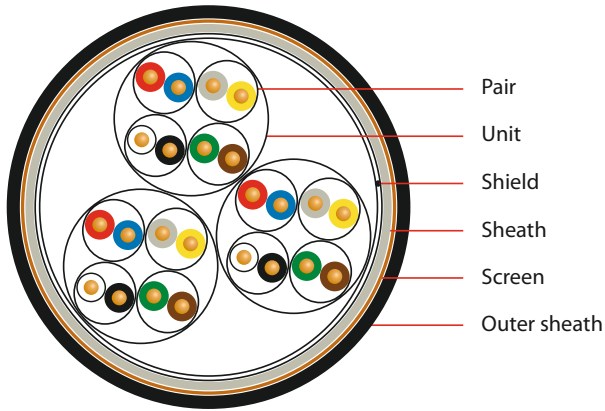

APPLICATION

This halogen-free, flame-resistant cable is used where increased fire protection of persons, material goods and buildings is required. It serves for signal transmission in communication systems with fixed installation. Not approved for power installation. Due to water absorption the cable should only be laid directly in earth or water if a protective conduit is used.

CONSTRUCTION

- Conductor:** copper, solid, bare (Ø 0.8 mm)
- Core insulation:** halogen-free compound
- Core stranding:** 2 cores to pair, 4 pairs to unit, units in layers; 2 x 2 as star quad
- Lapping:** plastic foil
- Shield:** tinned drain wire (Ø 0.8 mm); plastic-laminated aluminium foil
- Sheath:** halogen-free compound
- Screen:** tinned copper wire braid (Ø 0.2 mm); optical coverage approx. 80 %
- Outer sheath:** halogen-free compound; colour: black RAL 9005

BEHAVIOUR UNDER FIRE CONDITIONS

- Zero halogen, non corrosive gases: IEC 60754-2, DIN EN 50267
- Flame retardant: IEC 60332-1-2, DIN EN 60332-1-2
- Fire retardant: IEC 60332-3-24, DIN EN 60332-3-24
- Smoke density: IEC 61034, DIN EN 61034

Dimension	Sheath thickness approx. mm	Diameter approx. mm	Cable weight approx. kg/km	Copper index kg/km
2 x 2 x 0.8	1.8	11.0	160	65
4 x 2 x 0.8	1.8	12.5	215	95
8 x 2 x 0.8	1.8	15.6	315	147
12 x 2 x 0.8	1.8	16.0	376	190
20 x 2 x 0.8	1.8	19.0	560	298

ELECTRICAL CHARACTERISTICS

(Conductor) loop resistance max.	73.2 Ω/km
Insulation resistance min.	100 MΩ x km
Mutual capacitance (800 Hz) max.	120 nF/km 2 and 4 pair cable plus 20% permitted 1 pair 180nF/km
Capacitance unbalance (800 Hz) max.	200 pF/100m 20% of values, min. one value max. 400 pF
Test voltage core-core	500 V 50 Hz 1 min
Test voltage core-screen	2000 V 50 Hz 1 min
Peak operating voltage	225 V

THERMAL & MECHANICAL PROPERTIES

Temperature range during installation	-5°C to +50°C
Temperature range stationary	-30°C to +70°C
Minimum bending radius	10 x diameter

Subject to changes due to technical progress and error



AJ-H(St)HDH Bd Si Cu3.5 mtp* Fca

in resemblance to DIN VDE 0815

* capable of maxi-termi-point

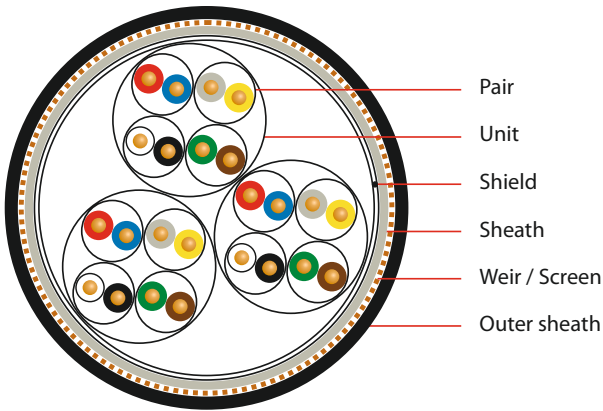

APPLICATION

This halogen-free, flame-resistant cable is used where increased fire protection of persons, material goods and buildings is required. It serves for signal transmission in communication systems with fixed installation. Not approved for power installation. Due to water absorption the cable should only be laid directly in earth or water if a protective conduit is used.

CONSTRUCTION

- Conductor:** copper, solid, bare (Ø 0.8 mm)
- Core insulation:** halogen-free compound
- Core stranding:** 2 cores to pair, 4 pairs to unit, units in layers; 2 x 2 as star quad
- Lapping:** plastic foil
- Shield:** tinned drain wire (Ø 0.8 mm); plastic-laminated aluminium foil
- Sheath:** halogen-free compound
- Weir / Screen:** cross section 3.5 mm²; surrounded with 7 bare copper wires (Ø 0.08 mm); lapping with plastic foil
- Outer sheath:** halogen-free compound; colour: black RAL 9005

BEHAVIOUR UNDER FIRE CONDITIONS

- Zero halogen, non corrosive gases: IEC 60754-2, DIN EN 50267
- Flame retardant: IEC 60332-1-2, DIN EN 60332-1-2
- Fire retardant: IEC 60332-3-24, DIN EN 60332-3-24
- Smoke density: IEC 61034, DIN EN 61034

Dimension	Sheath thickness approx. mm	Diameter approx. mm	Cable weight approx. kg/km	Copper index kg/km
2 x 2 x 0.8	1.8	12.2	185	60
4 x 2 x 0.8	1.8	13.5	225	81
8 x 2 x 0.8	1.8	16.5	320	121
12 x 2 x 0.8	1.8	17.5	375	162
16 x 2 x 0.8	1.8	18.5	440	203
20 x 2 x 0.8	1.8	20.2	515	280
32 x 2 x 0.8	2.0	25.5	775	358
40 x 2 x 0.8	2.0	27.0	900	440

ELECTRICAL CHARACTERISTICS

(Conductor) loop resistance max.	73.2 Ω/km
Insulation resistance min.	100 MΩ x km
Mutual capacitance (800 Hz) max.	120 nF/km 2 and 4 pair cable plus 20% permitted 1 pair 180nF/km
Capacitance unbalance (800 Hz) max.	200 pF/100m 20% of values, min. one value max. 400 pF
Test voltage core-core	500 V 50 Hz 1 min
Test voltage core-screen	2000 V 50 Hz 1 min
Peak operating voltage	225 V

THERMAL & MECHANICAL PROPERTIES

Temperature range during installation	-5°C to +50°C
Temperature range stationary	-30°C to +70°C
Minimum bending radius	10 x diameter

Subject to changes due to technical progress and error



A-H(St)HSH Bd Si mtp* Fca

in resemblance to DIN VDE 0815

* capable of maxi-termi-point

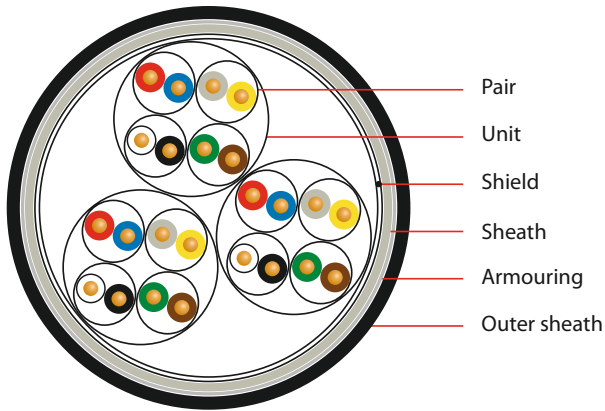

APPLICATION

This halogen-free, flame-resistant cable is used where increased fire protection of persons, material goods and buildings is required. It serves for signal transmission in communication systems with fixed installation. Not approved for power installation. Due to water absorption the cable should only be laid directly in earth or water if a protective conduit is used.

CONSTRUCTION

Conductor: copper, solid, bare (Ø 0.8 mm)

Core insulation: halogen-free compound

Core stranding: 2 cores to pair, 4 pairs to unit, units in layers; 2 x 2 as star quad

Lapping: plastic foil

Shield: tinned drain wire (Ø 0.8 mm); plastic-laminated aluminium foil

Sheath: halogen-free compound

Armouring: galvanized steel wire braid (Ø 0.24 mm); optical coverage approx. 80 %

Outer sheath: halogen-free compound; colour: black RAL 9005

BEHAVIOUR UNDER FIRE CONDITIONS

Zero halogen, non corrosive gases: IEC 60754-2, DIN EN 50267

Flame retardant: IEC 60332-1-2, DIN EN 60332-1-2

Fire retardant: IEC 60332-3-24, DIN EN 60332-3-24

Smoke density: IEC 61034, DIN EN 61034

Dimension	Sheath thickness approx. mm	Diameter approx. mm	Cable weight approx. kg/km	Copper index kg/km
2 x 2 x 0.8	1.8	11.0	180	25
4 x 2 x 0.8	1.8	12.5	235	45
8 x 2 x 0.8	1.8	15.5	350	85
12 x 2 x 0.8	1.8	16.0	410	126
16 x 2 x 0.8	1.8	17.0	480	166
20 x 2 x 0.8	1.8	19.0	560	206
32 x 2 x 0.8	2.0	24.0	850	327
40 x 2 x 0.8	2.0	26.0	960	407

ELECTRICAL CHARACTERISTICS

(Conductor) loop resistance max.	73.2 Ω/km
Insulation resistance min.	100 MΩ x km
Mutual capacitance (800 Hz) max.	120 nF/km 2 and 4 pair cable plus 20% permitted 1 pair 180nF/km
Capacitance unbalance (800 Hz) max.	200 pF/100m 20% of values, min. one value max. 400 pF
Test voltage core-core	500 V 50 Hz 1 min
Test voltage core-screen	2000 V 50 Hz 1 min
Peak operating voltage	225 V

THERMAL & MECHANICAL PROPERTIES

Temperature range during installation	-5°C to +50°C
Temperature range stationary	-30°C to +70°C
Minimum bending radius	10 x diameter

Subject to changes due to technical progress and error



AJ-HCHDH Bd Si Cu16 mtp* Fca

in resemblance to DIN VDE 0815

* capable of maxi-termi-point

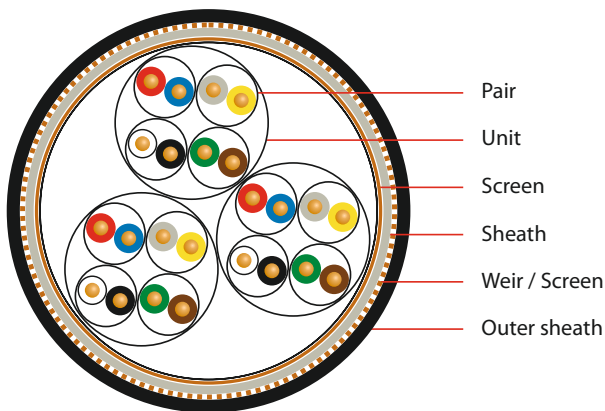

APPLICATION

This halogen-free, flame-resistant cable is used where increased fire protection of persons, material goods and buildings is required. It serves for signal transmission in communication systems with fixed installation. Not approved for power installation. Due to water absorption the cable should only be laid directly in earth or water if a protective conduit is used.

CONSTRUCTION

- Conductor:** copper, solid, bare (Ø 0.8 mm)
- Core insulation:** halogen-free compound
- Core stranding:** 2 cores to pair, 4 pairs to unit, units in layers; 2 x 2 as star quad
- Lapping:** plastic foil
- Screen:** tinned copper wire braid (Ø 0.2 mm)
- Sheath:** halogen-free compound
- Weir / Screen:** cross section 16 mm²; surrounded with 16 bare copper wires (Ø 1.13 mm); lapping with plastic foil
- Outer sheath:** halogen-free compound; colour: black RAL 9005

BEHAVIOUR UNDER FIRE CONDITIONS

- Zero halogen, non corrosive gases: IEC 60754-2, DIN EN 50267
- Flame retardant: IEC 60332-1-2, DIN EN 60332-1-2
- Fire retardant: IEC 60332-3-24, DIN EN 60332-3-24
- Smoke density: IEC 61034, DIN EN 61034

Dimension	Sheath thickness approx. mm	Diameter approx. mm	Cable weight approx. kg/km	Copper index kg/km
2 x 2 x 0.8	1.4	12.4	300	210
4 x 2 x 0.8	1.4	14.2	355	242
8 x 2 x 0.8	1.4	17.4	465	303
12 x 2 x 0.8	1.4	18.5	540	349
16 x 2 x 0.8	1.4	19.6	605	394
20 x 2 x 0.8	1.4	20.8	675	442
32 x 2 x 0.8	1.8	21.6	960	587
40 x 2 x 0.8	1.8	24.6	1110	686

ELECTRICAL CHARACTERISTICS

(Conductor) loop resistance max.	73.2 Ω/km
Insulation resistance min.	100 MΩ x km
Mutual capacitance (800 Hz) max.	120 nF/km 2 and 4 pair cable plus 20% permitted 1 pair 180nF/km
Capacitance unbalance (800 Hz) max.	200 pF/100m 20% of values, min. one value max. 400 pF
Test voltage core-core	500 V 50 Hz 1 min
Test voltage core-screen	2000 V 50 Hz 1 min
Peak operating voltage	225 V

THERMAL & MECHANICAL PROPERTIES

Temperature range during installation	-5°C to +50°C
Temperature range stationary	-30°C to +70°C
Minimum bending radius	15 x diameter

Subject to changes due to technical progress and error



AJ-HCHD2Y Bd Si Cu16 mtp* Fca

in resemblance to DIN VDE 0815

* capable of maxi-termi-point

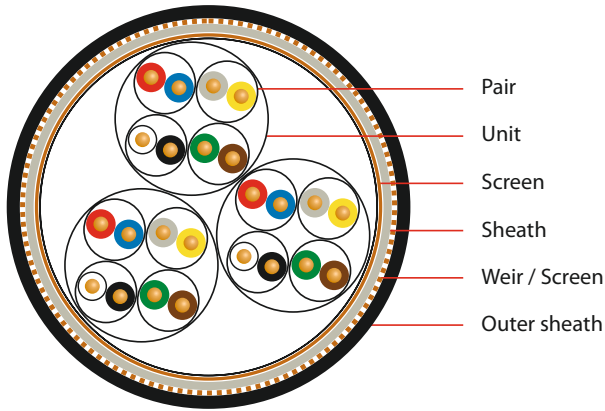

APPLICATION

This halogen-free, flame-resistant cable is used where increased fire protection of persons, material goods and buildings is required. It serves for signal transmission in communication systems with fixed installation. Not approved for power installation. Due to water absorption the cable should only be laid directly in earth or water if a protective conduit is used.

CONSTRUCTION

Conductor: copper, solid, bare (Ø 0.8 mm)

Core insulation: halogen-free compound

Core stranding: 2 cores to pair, 4 pairs to unit, units in layers; 2 x 2 as star quad

Lapping: plastic foil

Screen: tinned copper wire braid (Ø 0.2 mm); optical coverage approx. 80 %

Sheath: halogen-free compound

Weir / Screen: cross section 16 mm²; surrounded with 16 bare copper wires (Ø 1.13 mm); lapping with plastic foil

Outer sheath: PE L/MD; colour: black RAL 9005

Dimension	Sheath thickness approx. mm	Diameter approx. mm	Cable weight approx. kg/km	Copper index kg/km
2 x 2 x 0.8	1.8	13.8	300	216
4 x 2 x 0.8	1.8	15.9	360	252
8 x 2 x 0.8	1.8	18.0	460	308
12 x 2 x 0.8	1.8	18.5	525	357
16 x 2 x 0.8	1.8	21.0	590	407
20 x 2 x 0.8	1.8	22.0	660	454
32 x 2 x 0.8	2.0	26.5	900	597
40 x 2 x 0.8	2.0	29.0	1060	699

ELECTRICAL CHARACTERISTICS

(Conductor) loop resistance max.	73.2 Ω/km
Insulation resistance min.	100 MΩ x km
Mutual capacitance (800 Hz) max.	120 nF/km 2 and 4 pair cable plus 20% permitted 1 pair 180nF/km
Capacitance unbalance (800 Hz) max.	200 pF/100m 20% of values, min. one value max. 400 pF
Test voltage core-core	500 V 50 Hz 1 min
Test voltage core-screen	2000 V 50 Hz 1 min
Peak operating voltage	225 V

THERMAL & MECHANICAL PROPERTIES

Temperature range during installation	-5°C to +50°C
Temperature range stationary	-30°C to +70°C
Minimum bending radius	15 x diameter

Subject to changes due to technical progress and error



A-LIH(St)HCH Bd Si mtp* Fca

in resemblance to DIN VDE 0815

* capable of maxi-termi-point

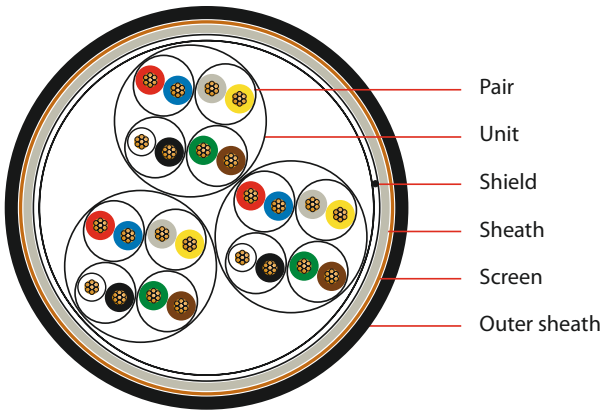

APPLICATION

This halogen-free, flame-resistant cable is used where increased fire protection of persons, material goods and buildings is required. It serves for signal transmission in communication systems with fixed installation. Not approved for power installation. Due to water absorption the cable should only be laid directly in earth or water if a protective conduit is used.

CONSTRUCTION

Conductor: copper strand, bare; $7 \times 0.3 \text{ mm} = 0.5 \text{ mm}^2$ ($\varnothing 0.9 \text{ mm}$)

Core insulation: halogen-free compound

Core stranding: 2 cores to pair, 4 pairs to unit, units in layers; 2 x 2 as star quad

Lapping: plastic foil

Shield: tinned drain wire ($\varnothing 0.8 \text{ mm}$); plastic-laminated aluminium foil

Sheath: halogen-free compound

Screen: tinned copper wire braid ($\varnothing 0.2 \text{ mm}$); optical coverage approx. 80 %

Outer sheath: halogen-free compound; colour: black RAL 9005

BEHAVIOUR UNDER FIRE CONDITIONS

Zero halogen, non corrosive gases: IEC 60754-2, DIN EN 50267

Flame retardant: IEC 60332-1-2, DIN EN 60332-1-2

Fire retardant: IEC 60332-3-24, DIN EN 60332-3-24

Smoke density: IEC 61034, DIN EN 61034

Dimension	Sheath thickness approx. mm	Diameter approx. mm	Cable weight approx. kg/km	Copper index kg/km
2 x 2 x 0.5	1.8	11.0	170	64
4 x 2 x 0.5	1.8	13.1	239	97
8 x 2 x 0.5	1.8	16.9	365	161
12 x 2 x 0.5	1.8	18.0	450	211
20 x 2 x 0.5	1.8	21.0	592	308
40 x 2 x 0.5	2.0	29.3	1100	572

ELECTRICAL CHARACTERISTICS

(Conductor) loop resistance max.	78.4 Ω /km
Insulation resistance min.	100 M Ω x km
Mutual capacitance (800 Hz) max.	120 nF/km 2 and 4 pair cable plus 20% permitted 1 pair 180nF/km
Capacitance unbalance (800 Hz) max.	200 pF/100m 20% of values, min. one value max. 400 pF
Test voltage core-core	500 V 50 Hz 1 min
Test voltage core-screen	2000 V 50 Hz 1 min
Peak operating voltage	225 V

THERMAL & MECHANICAL PROPERTIES

Temperature range moved	-5°C to +50°C
Temperature range static	-30°C to +70°C
Minimum bending radius	10 x diameter

Subject to changes due to technical progress and error



A-LIHCH Bd Si mtp* Fca

in resemblance to DIN VDE 0815

* capable of maxi-termi-point

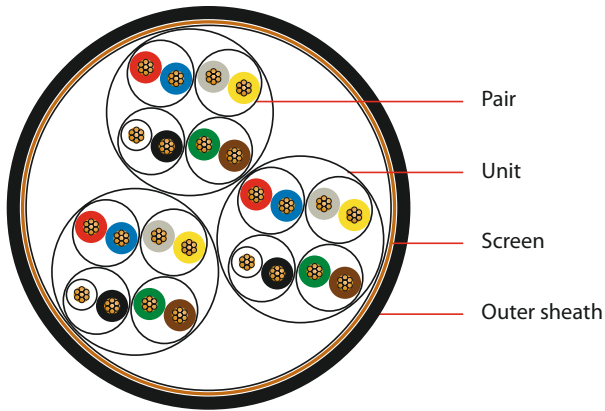

Dimension	Sheath thickness approx. mm	Diameter approx. mm	Cable weight approx. kg/km	Copper index kg/km
2 x 2 x 0.5	1.8	8.5	110	45
4 x 2 x 0.5	1.8	10.8	165	79
8 x 2 x 0.5	1.8	13.0	250	135
12 x 2 x 0.5	1.8	15.2	330	193
16 x 2 x 0.5	1.8	16.5	400	243
20 x 2 x 0.5	1.8	18.2	470	292
32 x 2 x 0.5	2.0	24.8	735	435
40 x 2 x 0.5	2.0	25.8	840	531

APPLICATION

This halogen-free, flame-resistant cable is used where increased fire protection of persons, material goods and buildings is required. It serves for signal transmission in communication systems with fixed installation. Not approved for power installation. Due to water absorption the cable should only be laid directly in earth or water if a protective conduit is used.

CONSTRUCTION

Conductor: copper strand, bare; 7 x 0.3 mm = 0.5 mm² (Ø 0.9 mm)

Core insulation: halogen-free compound

Core stranding: 2 cores to pair, 4 pairs to unit, units in layers; 2 x 2 as star quad

Lapping: plastic foil

Screen: tinned copper wire braid (Ø 0.2 mm)

Outer sheath: halogen-free compound; colour: black RAL 9005

BEHAVIOUR UNDER FIRE CONDITIONS

Zero halogen, non corrosive gases: IEC 60754-2, DIN EN 50267

Flame retardant: IEC 60332-1-2, DIN EN 60332-1-2

Fire retardant: IEC 60332-3-24, DIN EN 60332-3-24

Smoke density: IEC 61034, DIN EN 61034

ELECTRICAL CHARACTERISTICS

(Conductor) loop resistance max.	78.4 Ω/km
Insulation resistance min.	100 MΩ x km
Mutual capacitance (800 Hz) max.	120 nF/km 2 and 4 pair cable plus 20% permitted 1 pair 180nF/km
Capacitance unbalance (800 Hz) max.	200 pF/100m 20% of values, min. one value max. 400 pF
Test voltage core-core	500 V 50 Hz 1 min
Test voltage core-screen	2000 V 50 Hz 1 min
Peak operating voltage	225 V

THERMAL & MECHANICAL PROPERTIES

Temperature range during installation	-5°C to +50°C
Temperature range stationary	-30°C to +70°C
Minimum bending radius	7.5 x diameter

Subject to changes due to technical progress and error



A-LIHCHCH Bd Si mtp* Fca

in resemblance to DIN VDE 0815

* capable of maxi-termi-point

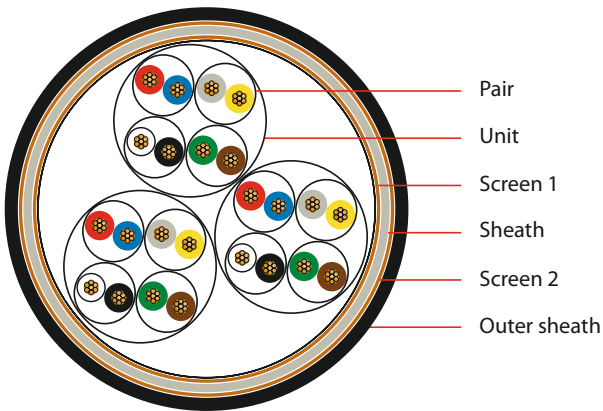

APPLICATION

This halogen-free, flame-resistant cable is used where increased fire protection of persons, material goods and buildings is required. It serves for signal transmission in communication systems with fixed installation. Not approved for power installation. Due to water absorption the cable should only be laid directly in earth or water if a protective conduit is used.

CONSTRUCTION

Conductor: copper strand, bare; $7 \times 0.3 \text{ mm} = 0.5 \text{ mm}^2$ ($\varnothing 0.9 \text{ mm}$)

Core insulation: halogen-free compound

Core stranding: 2 cores to pair, 4 pairs to unit, units in layers; 2 x 2 as star quad

Lapping: plastic foil

Screen 1: tinned copper wire braid ($\varnothing 0.2 \text{ mm}$)

Sheath: halogen-free compound

Screen 2: tinned copper wire braid ($\varnothing 0.2 \text{ mm}$); optical coverage approx. 80 %

Outer sheath: halogen-free compound; colour: black RAL 9005

BEHAVIOUR UNDER FIRE CONDITIONS

Zero halogen, non corrosive gases: IEC 60754-2, DIN EN 50267

Flame retardant: IEC 60332-1-2, DIN EN 60332-1-2

Fire retardant: IEC 60332-3-24, DIN EN 60332-3-24

Smoke density: IEC 61034, DIN EN 61034

Dimension	Sheath thickness approx. mm	Diameter approx. mm	Cable weight approx. kg/km	Copper index kg/km
2 x 2 x 0.5	1.8	11.3	195	86
4 x 2 x 0.5	1.8	13.6	275	134
8 x 2 x 0.5	1.8	15.9	380	204
12 x 2 x 0.5	1.8	18.5	500	274
16 x 2 x 0.5	1.8	19.8	580	333
20 x 2 x 0.5	1.8	21.2	660	392
32 x 2 x 0.5	2.0	26.4	970	582
40 x 2 x 0.5	2.0	29.5	1170	683

ELECTRICAL CHARACTERISTICS

(Conductor) loop resistance max.	78.4 Ω /km
Insulation resistance min.	100 M Ω x km
Mutual capacitance (800 Hz) max.	120 nF/km 2 and 4 pair cable plus 20% permitted 1 pair 180nF/km
Capacitance unbalance (800 Hz) max.	200 pF/100m 20% of values, min. one value max. 400 pF
Test voltage core-core	500 V 50 Hz 1 min
Test voltage core-screen	2000 V 50 Hz 1 min
Peak operating voltage	225 V

THERMAL & MECHANICAL PROPERTIES

Temperature range during installation	-5°C to +50°C
Temperature range stationary	-30°C to +70°C
Minimum bending radius	10 x diameter

Subject to changes due to technical progress and error



A-LIHCHCH PimF Bd Si mtp* Fca

in resemblance to DIN VDE 0815

* capable of maxi-termi-point

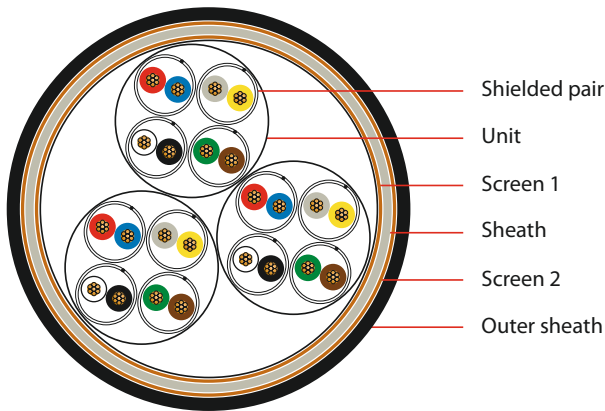

Dimension	Sheath thickness approx. mm	Diameter approx. mm	Cable weight approx. kg/km	Copper index kg/km
2 x 2 x 0.5	1.8	13.5	265	110
4 x 2 x 0.5	1.8	13.9	305	137
8 x 2 x 0.5	1.8	18.5	495	240
12 x 2 x 0.5	1.8	19.3	580	288
16 x 2 x 0.5	1.8	20.7	675	349
20 x 2 x 0.5	1.8	22.6	795	425
32 x 2 x 0.5	2.0	26.5	1100	592
40 x 2 x 0.5	2.0	31.0	1370	729

APPLICATION

This halogen-free, flame-resistant cable is used where increased fire protection of persons, material goods and buildings is required. It serves for signal transmission in communication systems with fixed installation. Not approved for power installation. Due to water absorption the cable should only be laid directly in earth or water if a protective conduit is used.

CONSTRUCTION

Conductor: copper strand, bare; 7 x 0.3 mm = 0.5 mm² (Ø 0.9 mm)

Core insulation: halogen-free compound

Shielded pairs: each pair one layer plastic tape;
 drain wire: tinned copper strand 7 x 0.16 mm;
 one layer plastic laminated aluminium foil

Core stranding: 2 cores to pair, 4 pairs to unit, units in layers;
 2 x 2 as star quad

Lapping: plastic foil

Screen 1: tinned copper wire braid (Ø 0.2 mm)

Sheath: halogen-free compound

Screen 2: tinned copper wire braid (Ø 0.2 mm);
 optical coverage approx. 80 %

Outer sheath: halogen-free compound; colour: black RAL 9005

BEHAVIOUR UNDER FIRE CONDITIONS

Zero halogen, non corrosive gases: IEC 60754-2, DIN EN 50267

Flame retardant: IEC 60332-1-2, DIN EN 60332-1-2

Fire retardant: IEC 60332-3-24, DIN EN 60332-3-24

Smoke density: IEC 61034, DIN EN 61034

ELECTRICAL CHARACTERISTICS

(Conductor) loop resistance max.	78.4 Ω/km
Insulation resistance min.	100 MΩ x km
Mutual capacitance (800 Hz) max.	180 nF/km
Capacitance unbalance (800 Hz) max.	200 pF/100m
Test voltage core-core	500 V 50 Hz 1 min
Test voltage core-screen	2000 V 50 Hz 1 min
Peak operating voltage	225 V

THERMAL & MECHANICAL PROPERTIES

Temperature range during installation	-5°C to +50°C
Temperature range stationary	-30°C to +70°C
Minimum bending radius	10 x diameter

Subject to changes due to technical progress and error





T.K. Kabel oHG

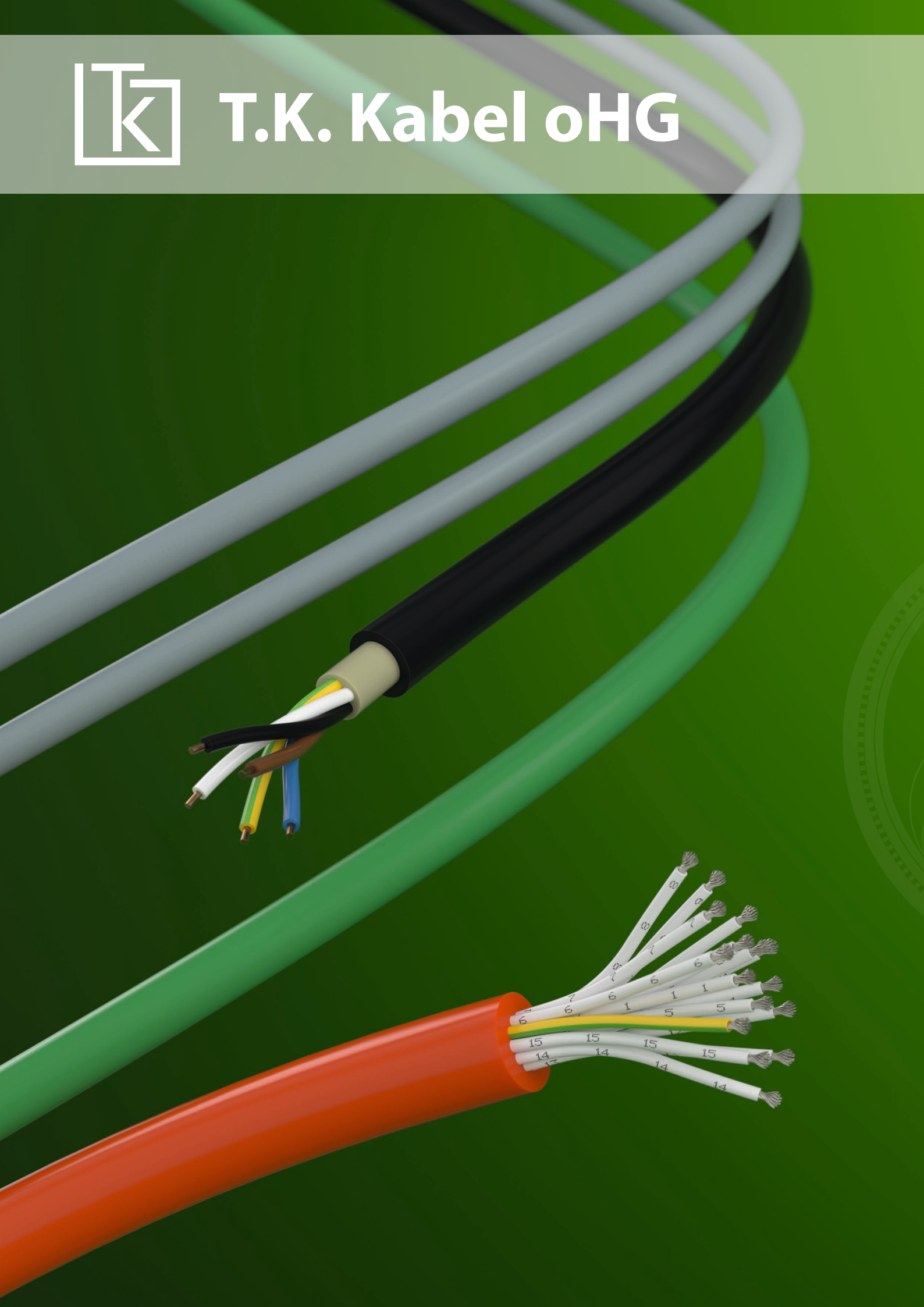

Special cables

Indoor cables

JE-Y(St)YT-FR Bd Si	50
JE-LIYCYT-FR Bd Si	51
JE-LIYCYSYT-FR Bd Si	52
<hr/>	
JE-LIH(St)HSO Bd Si mtp Fca	53
JE-LIHCHSOT Bd Si mtp	54
JE-LIHCHSHSOT Bd Si mtp	55

Outdoor cables

AJ-Y(St)YDYT-FR Bd Si Cu3.5	56
A-Y(St)YSYT-FR Bd Si	57
<hr/>	
A-H(St)HSO Bd Si mtp Fca	58
A-H(St)HCHSOT Bd Si mtp	59
A-H(St)HDSHSOT Bd Si mtp	60
AJ-HCHDHSO Bd Si Cu16 mtp Fca	61

JE-Y(St)YT-FR Bd Si

in resemblance to DIN VDE 0815

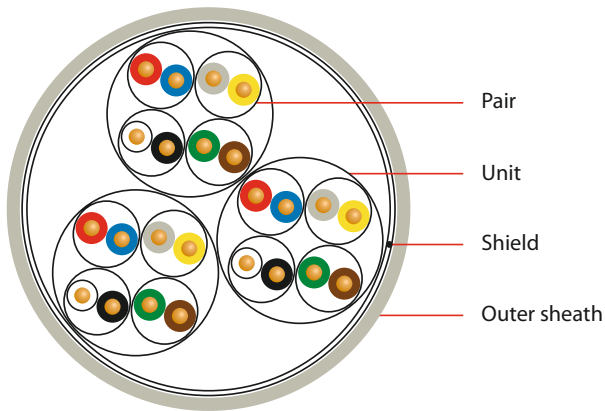

APPLICATION

For information transmission in dry and moist production sites, in and under plaster, as well as outdoors for fixed installation. Not approved for power and underground installation.

CONSTRUCTION

Conductor: copper, solid, bare (Ø 0.8 mm)

Core insulation: PVC

Core stranding: 2 cores to pair, 4 pairs to unit, units in layers; 2 x 2 as star quad

Lapping: plastic foil

Shield: tinned drain wire (Ø 0.8 mm); plastic-laminated aluminium foil

Outer sheath: PVC-FR; termite protected; colour: pebble grey RAL 7032 or blue RAL 5015

BEHAVIOUR UNDER FIRE CONDITIONS

Fire retardant: IEC 60332-3-24, DIN EN 60332-3-24

Low smoke and fume

Dimension	Sheath thickness approx. mm	Diameter approx. mm	Cable weight approx. kg/km	Copper index kg/km
2 x 2 x 0.8	1.0	6.6	55	25
4 x 2 x 0.8	1.0	8.3	87	45
8 x 2 x 0.8	1.0	10.5	146	85
12 x 2 x 0.8	1.0	11.8	200	126
16 x 2 x 0.8	1.2	13.5	270	166
20 x 2 x 0.8	1.2	14.7	325	206
32 x 2 x 0.8	1.4	19.0	510	327
40 x 2 x 0.8	1.4	20.7	610	407

ELECTRICAL CHARACTERISTICS

(Conductor) loop resistance max.	73.2 Ω/km
Insulation resistance min.	100 MΩ x km
Mutual capacitance (800 Hz) max.	100 nF/km 2 and 4 pair cable plus 20% permitted 1 pair 180nF/km
Capacitance unbalance (800 Hz) max.	200 pF/100m 20% of values, min. one value max. 400 pF
Test voltage core-core	500 V 50 Hz 1 min
Test voltage core-screen	2000 V 50 Hz 1 min
Peak operating voltage	225 V

THERMAL & MECHANICAL PROPERTIES

Temperature range during installation	-5°C to +50°C
Temperature range stationary	-30°C to +70°C
Minimum bending radius	10 x diameter

Subject to changes due to technical progress and error



T.K. Kabel oHG · Geschwister-Scholl-Straße 11 · 71384 Weinstadt

Phone +49 (0) 7151/60 68 70 · Fax +49 (0) 7151/60 91 00 · info@tk-kabel.de · www.tk-kabel.de

JE-LIYCYT-FR Bd Si

in resemblance to DIN VDE 0815

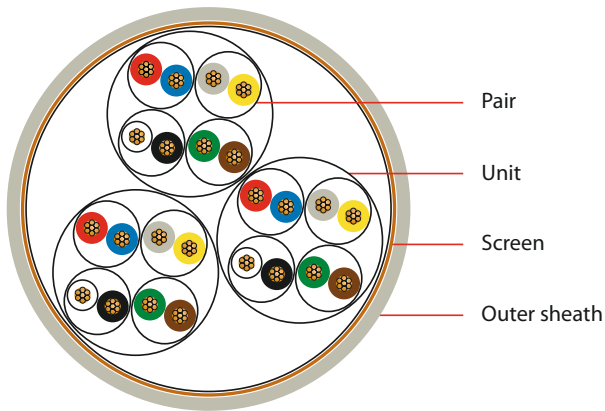

APPLICATION

For information transmission in dry and moist production sites, in and under plaster, as well as outdoors for fixed installation. Not approved for power and underground installation.

CONSTRUCTION

Conductor: copper strand, bare; $7 \times 0.3 \text{ mm} = 0.5 \text{ mm}^2$ ($\varnothing 0.9 \text{ mm}$)

Core insulation: PVC

Core stranding: 2 cores to pair, 4 pairs to unit, units in layers; 2 x 2 as star quad

Lapping: plastic foil

Screen: tinned copper wire braid ($\varnothing 0.2 \text{ mm}$); optical coverage approx. 80 %

Outer sheath: PVC-FR; termite protected; colour: pebble grey RAL 7032 or blue RAL 5015

BEHAVIOUR UNDER FIRE CONDITIONS

Fire retardant: IEC 60332-3-24, DIN EN 60332-3-24

Low smoke and fume

Dimension	Sheath thickness approx. mm	Diameter approx. mm	Cable weight approx. kg/km	Copper index kg/km
2 x 2 x 0.5	1.0	7.0	82	48
4 x 2 x 0.5	1.0	8.6	130	84
8 x 2 x 0.5	1.0	12.0	215	140
12 x 2 x 0.5	1.2	13.1	280	193
16 x 2 x 0.5	1.2	14.3	340	243
20 x 2 x 0.5	1.2	15.5	400	292
32 x 2 x 0.5	1.4	20.5	620	435
40 x 2 x 0.5	1.4	22.5	730	531

ELECTRICAL CHARACTERISTICS

(Conductor) loop resistance max.	78.4 Ω /km
Insulation resistance min.	100 M Ω x km
Mutual capacitance (800 Hz) max.	100 nF/km 2 and 4 pair cable plus 20% permitted 1 pair 180nF/km
Capacitance unbalance (800 Hz) max.	200 pF/100m 20% of values, min. one value max. 400 pF
Inductance (guide value)	0.61 mH/km
Test voltage core-core	500 V 50 Hz 1 min
Test voltage core-screen	2000 V 50 Hz 1 min
Peak operating voltage	225 V

THERMAL & MECHANICAL PROPERTIES

Temperature range during installation	-5°C to +50°C
Temperature range stationary	-30°C to +70°C
Minimum bending radius	10 x diameter

Subject to changes due to technical progress and error



T.K. Kabel oHG · Geschwister-Scholl-Straße 11 · 71384 Weinstadt
Phone +49 (0) 7151/60 68 70 · Fax +49 (0) 7151/60 91 00 · info@tk-kabel.de · www.tk-kabel.de

JE-LIYCYSYT-FR Bd Si

in resemblance to DIN VDE 0815

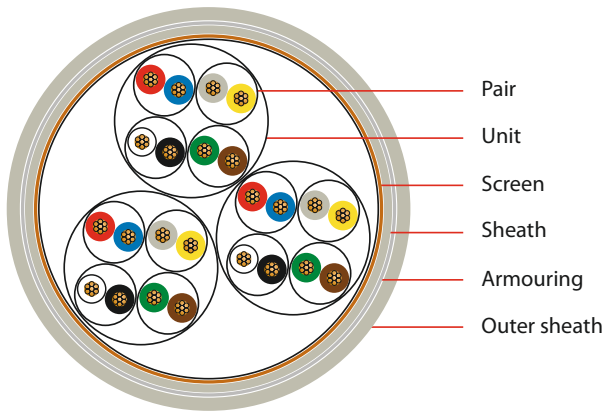

APPLICATION

For information transmission in dry and moist production sites, in and under plaster, as well as outdoors for fixed installation. Not approved for power and underground installation.

CONSTRUCTION

Conductor: copper strand, bare; $7 \times 0.3 \text{ mm} = 0.5 \text{ mm}^2$ ($\varnothing 0.9 \text{ mm}$)

Core insulation: PVC

Core stranding: 2 cores to pair, 4 pairs to unit, units in layers; 2 x 2 as star quad

Lapping: plastic foil

Screen: tinned copper wire braid ($\varnothing 0.2 \text{ mm}$); optical coverage approx. 80 %

Sheath: PVC

Armouring: galvanized steel wire braid ($\varnothing 0.2 \text{ mm}$); optical coverage approx. 80 %

Outer sheath: PVC-FR; termite protected; colour: pebble grey RAL 7032 or blue RAL 5015

BEHAVIOUR UNDER FIRE CONDITIONS

Fire retardant: IEC 60332-3-24, DIN EN 60332-3-24

Low smoke and fume

Dimension	Sheath thickness approx. mm	Diameter approx. mm	Cable weight approx. kg/km	Copper index kg/km
2 x 2 x 0.5	1.4	11.0	190	48
4 x 2 x 0.5	1.4	13.0	260	84
8 x 2 x 0.5	1.4	16.0	385	140
12 x 2 x 0.5	1.4	17.0	470	193
16 x 2 x 0.5	1.4	18.0	545	243
20 x 2 x 0.5	1.4	19.5	620	292
32 x 2 x 0.5	1.8	25.5	970	435
40 x 2 x 0.5	1.8	27.0	1120	531

ELECTRICAL CHARACTERISTICS

(Conductor) loop resistance max.	78.4 Ω /km
Insulation resistance min.	100 M Ω x km
Mutual capacitance (800 Hz) max.	120 nF/km 2 and 4 pair cable plus 20% permitted 1 pair 180nF/km
Capacitance unbalance (800 Hz) max.	200 pF/100m 20% of values, min. one value max. 400 pF
Inductance (guide value)	0.61 mH/km
Test voltage core-core	500 V 50 Hz 1 min
Test voltage core-screen	2000 V 50 Hz 1 min
Peak operating voltage	225 V

THERMAL & MECHANICAL PROPERTIES

Temperature range during installation	-5°C to +50°C
Temperature range stationary	-30°C to +70°C
Minimum bending radius	10 x diameter

Subject to changes due to technical progress and error



T.K. Kabel oHG · Geschwister-Scholl-Straße 11 · 71384 Weinstadt

Phone +49 (0) 7151/60 68 70 · Fax +49 (0) 7151/60 91 00 · info@tk-kabel.de · www.tk-kabel.de

JE-LIH(St)HSO Bd Si mtp* Fca

in resemblance to DIN VDE 0815

* capable of maxi-termi-point

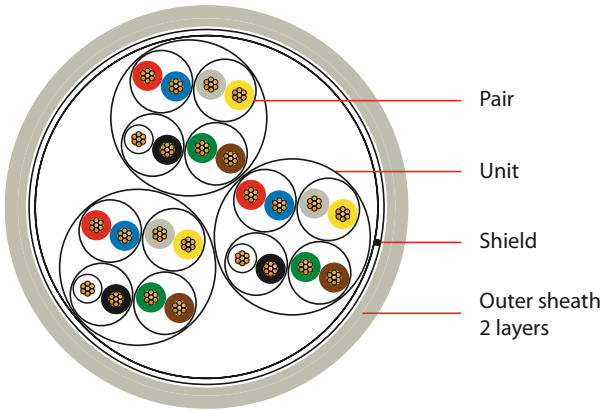

Dimension	Sheath thickness approx. mm	Diameter approx. mm	Cable weight approx. kg/km	Copper index kg/km
2 x 2 x 0.5	1.0	10.0	130	26
4 x 2 x 0.5	1.0	11.8	180	47
8 x 2 x 0.5	1.0	14.9	275	89
12 x 2 x 0.5	1.0	15.6	335	132
20 x 2 x 0.5	1.2	17.9	465	216

APPLICATION

This halogen-free, flame-resistant cable is used where increased fire protection of persons, material goods and buildings is required. It serves for signal transmission in communication systems with fixed installation. Not approved for power installation. Appropriate for water installation.

CONSTRUCTION

Conductor: copper strand, bare; 7 x 0.3 mm = 0.5 mm² (Ø 0.9 mm)

Core insulation: halogen-free compound

Core stranding: 2 cores to pair, 4 pairs to unit, units in layers; 2 x 2 as star quad

Lapping: plastic foil

Shield: tinned drain wire 0.5 mm²; plastic-laminated aluminium foil

Outer sheath:

layer 1: halogen-free compound

layer 2: special halogen-free compound,

colour: pebble grey RAL 7032 or blue RAL 5015

BEHAVIOUR UNDER FIRE CONDITIONS

Zero halogen, non corrosive gases: IEC 60754-2, DIN EN 50267

Flame retardant: IEC 60332-1-2, DIN EN 60332-1-2

Fire retardant: IEC 60332-3-24, DIN EN 60332-3-24

Smoke density: IEC 61034, DIN EN 61034

ELECTRICAL CHARACTERISTICS

(Conductor) loop resistance max.	78.4 Ω/km
Insulation resistance min.	100 MΩ x km
Mutual capacitance (800 Hz) max.	120 nF/km 2 and 4 pair cable plus 20% permitted 1 pair 180nF/km
Capacitance unbalance (800 Hz) max.	200 pF/100m 20% of values, min. one value max. 400 pF
Test voltage core-core	500 V 50 Hz 1 min
Test voltage core-screen	2000 V 50 Hz 1 min
Peak operating voltage	225 V

THERMAL & MECHANICAL PROPERTIES

Temperature range during installation	-5°C to +50°C
Temperature range stationary	-30°C to +70°C
Minimum bending radius	10 x diameter

Subject to changes due to technical progress and error



JE-LIHCHSOT Bd Si mtp*

in resemblance to DIN VDE 0815

* capable of maxi-termi-point

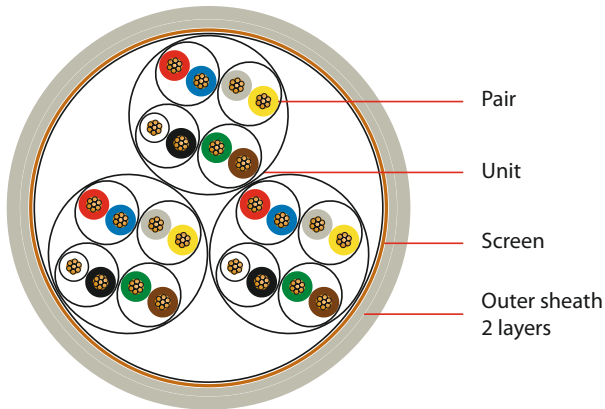

APPLICATION

This halogen-free, flame-resistant cable is used where increased fire protection of persons, material goods and buildings is required. It serves for signal transmission in communication systems with fixed installation. Not approved for power installation. Termite resistant. Appropriate for water installation.

CONSTRUCTION

Conductor: copper strand, bare; $7 \times 0.3 \text{ mm} = 0.5 \text{ mm}^2$ ($\varnothing 0.9 \text{ mm}$)

Core insulation: halogen-free compound

Core stranding: 2 cores to pair, 4 pairs to unit, units in layers; 2 x 2 as star quad

Lapping: plastic foil

Screen: tinned copper wire braid ($\varnothing 0.2 \text{ mm}$)

Outer sheath:

layer 1: halogen-free compound

layer 2: special halogen-free compound; termite protected;

colour: pebble grey RAL 7032 or blue RAL 5015

BEHAVIOUR UNDER FIRE CONDITIONS

Zero halogen, non corrosive gases: IEC 60754-2, DIN EN 50267

Flame retardant: IEC 60332-1-2, DIN EN 60332-1-2

Fire retardant: IEC 60332-3-24, DIN EN 60332-3-24

Smoke density: IEC 61034, DIN EN 61034

Dimension	Sheath thickness approx. mm	Diameter approx. mm	Cable weight approx. kg/km	Copper index kg/km
2 x 2 x 0.5	0.7	8.2	100	48
4 x 2 x 0.5	0.7	10.5	155	84
8 x 2 x 0.5	0.7	13.1	245	140
12 x 2 x 0.5	0.8	15.7	340	193
16 x 2 x 0.5	0.8	17.0	410	243
20 x 2 x 0.5	0.8	18.4	475	292

ELECTRICAL CHARACTERISTICS

(Conductor) loop resistance max.	78.4 Ω /km
Insulation resistance min.	100 M Ω x km
Mutual capacitance (800 Hz) max.	120 nF/km 2 and 4 pair cable plus 20% permitted 1 pair 180nF/km
Capacitance unbalance (800 Hz) max.	200 pF/100m 20% of values, min. one value max. 400 pF
Test voltage core-core	500 V 50 Hz 1 min
Test voltage core-screen	2000 V 50 Hz 1 min
Peak operating voltage	225 V

THERMAL & MECHANICAL PROPERTIES

Temperature range during installation	-5°C to +50°C
Temperature range stationary	-30°C to +70°C
Minimum bending radius	10 x diameter

Subject to changes due to technical progress and error



T.K. Kabel oHG · Geschwister-Scholl-Straße 11 · 71384 Weinstadt

Phone +49 (0) 7151/60 68 70 · Fax +49 (0) 7151/60 91 00 · info@tk-kabel.de · www.tk-kabel.de

JE-LIHCHSHSOT Bd Si mtp*

in resemblance to DIN VDE 0815

* capable of maxi-termi-point

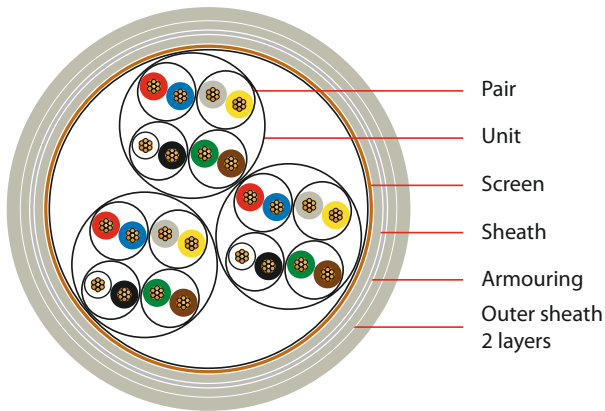

APPLICATION

This halogen-free, flame-resistant cable is used where increased fire protection of persons, material goods and buildings is required. It serves for signal transmission in communication systems with fixed installation. Not approved for power installation. Termite resistant and rodent proof. Appropriate for water installation.

CONSTRUCTION

Conductor: copper strand, bare; $7 \times 0.3 \text{ mm} = 0.5 \text{ mm}^2$ ($\varnothing 0.9 \text{ mm}$)

Core insulation: halogen-free compound

Core stranding: 2 cores to pair, 4 pairs to unit, units in layers; 2 x 2 as star quad

Lapping: plastic foil

Screen: tinned copper wire braid ($\varnothing 0.2 \text{ mm}$)

Sheath: halogen free compound

Armouring: galvanized steel wire braid ($\varnothing 0.24 \text{ mm}$); optical coverage > 60 %

Outer sheath:

layer 1: halogen-free compound

layer 2: special halogen-free compound; termite protected;

colour: pebble grey RAL 7032 or blue RAL 5015

BEHAVIOUR UNDER FIRE CONDITIONS

Zero halogen, non corrosive gases: IEC 60754-2, DIN EN 50267

Flame retardant: IEC 60332-1-2, DIN EN 60332-1-2

Fire retardant: IEC 60332-3-24, DIN EN 60332-3-24

Smoke density: IEC 61034, DIN EN 61034

Dimension	Sheath thickness approx. mm	Diameter approx. mm	Cable weight approx. kg/km	Copper index kg/km
2 x 2 x 0.5	1.4	10.7	165	48
4 x 2 x 0.5	1.4	13.0	240	84
8 x 2 x 0.5	1.8	16.1	365	140
12 x 2 x 0.5	1.8	18.8	485	193
16 x 2 x 0.5	1.8	20.0	565	243
20 x 2 x 0.5	1.8	21.4	645	292

ELECTRICAL CHARACTERISTICS

(Conductor) loop resistance max.	78.4 Ω /km
Insulation resistance min.	100 M Ω x km
Mutual capacitance (800 Hz) max.	120 nF/km 2 and 4 pair cable plus 20% permitted 1 pair 180nF/km
Capacitance unbalance (800 Hz) max.	200 pF/100m 20% of values, min. one value max. 400 pF
Test voltage core-core	500 V 50 Hz 1 min
Test voltage core-screen	2000 V 50 Hz 1 min
Peak operating voltage	225 V

THERMAL & MECHANICAL PROPERTIES

Temperature range during installation	-5°C to +50°C
Temperature range stationary	-30°C to +70°C
Minimum bending radius	10 x diameter

Subject to changes due to technical progress and error



AJ-Y(St)YDYT-FR Bd Si Cu3.5

in resemblance to DIN VDE 0815

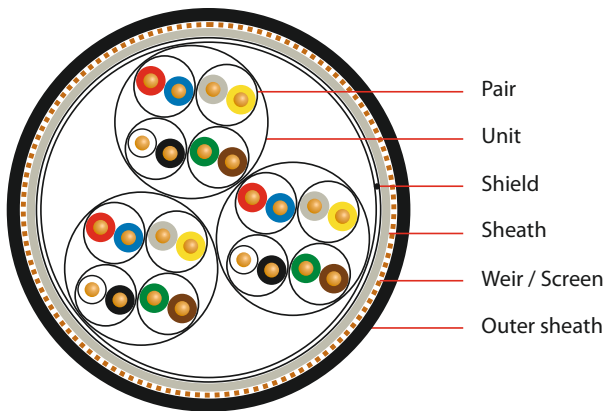

APPLICATION

For information transmission in dry and moist production sites, in and under plaster, as well as outdoors for fixed installation. Not approved for power installation, but appropriate for underground installation.

CONSTRUCTION

Conductor: copper, solid, bare (\varnothing 0.8 mm)

Core insulation: PVC

Core stranding: 2 cores to pair, 4 pairs to unit, units in layers; 2 x 2 as star quad

Lapping: plastic foil

Shield: tinned drain wire (\varnothing 0.8 mm); plastic-laminated aluminium foil

Sheath: PVC

Weir / Screen: cross section 3.5 mm²; surrounded with 7 bare copper wires (\varnothing 0.8 mm); lapping with plastic foil

Outer sheath: PVC-FR; termite protected; colour: black RAL 9005

BEHAVIOUR UNDER FIRE CONDITIONS

Fire retardant: IEC 60332-3-24, DIN EN 60332-3-24

Low smoke and fume

Dimension	Sheath thickness approx. mm	Diameter approx. mm	Cable weight approx. kg/km	Copper index kg/km
2 x 2 x 0.8	1.8	12.2	175	60
4 x 2 x 0.8	1.8	13.5	225	81
8 x 2 x 0.8	1.8	16.5	315	121
12 x 2 x 0.8	1.8	17.0	365	162
16 x 2 x 0.8	1.8	18.0	430	203
20 x 2 x 0.8	1.8	20.0	510	280
32 x 2 x 0.8	2.0	25.0	770	358
40 x 2 x 0.8	2.0	26.5	880	440

ELECTRICAL CHARACTERISTICS

(Conductor) loop resistance max.	73.2 Ω /km
Insulation resistance min.	100 M Ω x km
Mutual capacitance (800 Hz) max.	100 nF/km 2 and 4 pair cable plus 20% permitted 1 pair 180nF/km
Capacitance unbalance (800 Hz) max.	200 pF/100m 20% of values, min. one value max. 400 pF
Test voltage core-core	500 V 50 Hz 1 min
Test voltage core-screen	2000 V 50 Hz 1 min
Peak operating voltage	225 V
Attenuation at 0.8 kHz approx.	0.11 dB/100m
Attenuation at 10 kHz approx.	0.29 dB/100m
Characteristic impedance (800 Hz)	approx. 320 Ω

THERMAL & MECHANICAL PROPERTIES

Temperature range during installation	-5°C to +50°C
Temperature range stationary	-30°C to +70°C
Minimum bending radius	10 x diameter

Subject to changes due to technical progress and error



T.K. Kabel oHG · Geschwister-Scholl-Straße 11 · 71384 Weinstadt

Phone +49 (0) 7151/60 68 70 · Fax +49 (0) 7151/60 91 00 · info@tk-kabel.de · www.tk-kabel.de

A-Y(St)YSYT-FR Bd Si

in resemblance to DIN VDE 0815

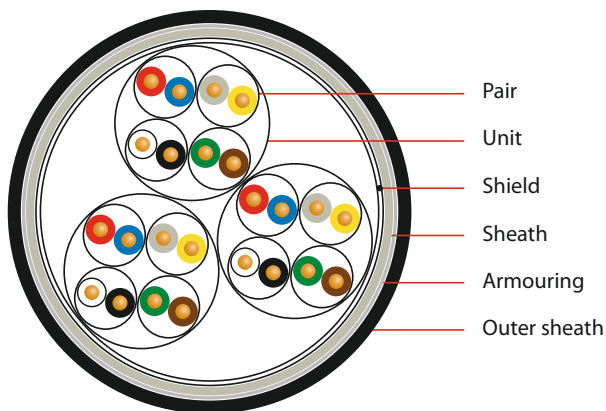

APPLICATION

For information transmission in dry and moist production sites, in and under plaster, as well as outdoors for fixed installation. Not approved for power installation, but appropriate for underground installation.

CONSTRUCTION

Conductor: copper, solid, bare (\varnothing 0.8 mm)

Core insulation: PVC

Core stranding: 2 cores to pair, 4 pairs to unit, units in layers; 2 x 2 as star quad

Lapping: plastic foil

Shield: tinned drain wire (\varnothing 0.8 mm); plastic-laminated aluminium foil

Sheath: PVC

Armouring: galvanized steel wire braid (\varnothing 0.24 mm); optical coverage approx. 80 %

Outer sheath: PVC-FR; termite protected; colour: black RAL 9005

BEHAVIOUR UNDER FIRE CONDITIONS

Fire retardant: IEC 60332-3-24, DIN EN 60332-3-24

Low smoke and fume

Dimension	Sheath thickness approx. mm	Diameter approx. mm	Cable weight approx. kg/km	Copper index kg/km
2 x 2 x 0.8	1.8	11.0	180	25
4 x 2 x 0.8	1.8	12.5	235	45
8 x 2 x 0.8	1.8	15.5	340	85
12 x 2 x 0.8	1.8	16.0	410	126
16 x 2 x 0.8	1.8	17.0	480	166
20 x 2 x 0.8	1.8	19.0	560	206
32 x 2 x 0.8	2.0	24.0	850	327
40 x 2 x 0.8	2.0	26.0	960	407

ELECTRICAL CHARACTERISTICS

(Conductor) loop resistance max.	73.2 Ω /km
Insulation resistance min.	100 M Ω x km
Mutual capacitance (800 Hz) max.	100 nF/km 2 and 4 pair cable plus 20% permitted 1 pair 180nF/km
Capacitance unbalance (800 Hz) max.	200 pF/100m 20% of values, min. one value max. 400 pF
Test voltage core-core	500 V 50 Hz 1 min
Test voltage core-screen	2000 V 50 Hz 1 min
Peak operating voltage	225 V

THERMAL & MECHANICAL PROPERTIES

Temperature range during installation	-5°C to +50°C
Temperature range stationary	-30°C to +70°C
Minimum bending radius	15 x diameter

Subject to changes due to technical progress and error



T.K. Kabel oHG · Geschwister-Scholl-Straße 11 · 71384 Weinstadt

Phone +49 (0) 7151/60 68 70 · Fax +49 (0) 7151/60 91 00 · info@tk-kabel.de · www.tk-kabel.de

A-H(St)HSO Bd Si mtp* Fca

in resemblance to DIN VDE 0815

* capable of maxi-termi-point

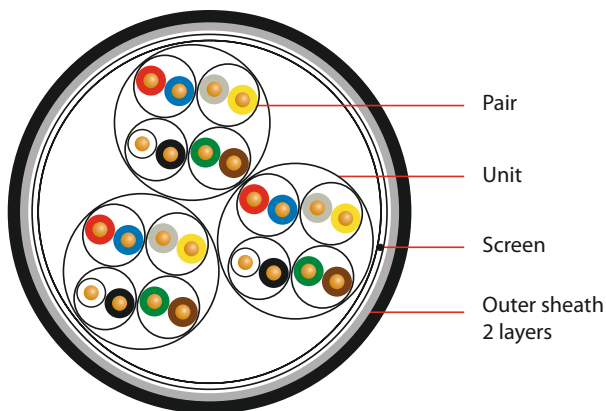

APPLICATION

This halogen-free, flame-resistant cable is used where increased fire protection of persons, material goods and buildings is required. It serves for signal transmission in communication systems with fixed installation, especially for use outdoors in drains, pipes and sand. Not approved for power installation. Appropriate for water installation.

CONSTRUCTION

Conductor: copper solid, bare (Ø 0.8 mm)

Core insulation: halogen free compound

Core stranding: 2 cores to pair, 4 pairs to unit, units in layers; 2 x 2 as star quad

Lapping: min. 2 layers plastic foil

Shield: tinned drain wire (Ø 0.8 mm); plastic-laminated aluminium foil

Outer sheath:

Inner layer: halogen free compound;

Outer layer: halogen free special compound; colour: black RAL 9005

BEHAVIOUR UNDER FIRE CONDITIONS

Zero halogen, non corrosive gases: IEC 60754-2, DIN EN 50267

Flame retardant: IEC 60332-1-2, DIN EN 60332-1-2

Fire retardant: IEC 60332-3-24, DIN EN 60332-3-24

Smoke density: IEC 61034, DIN EN 61034

Dimension	Sheath thickness approx. mm	Diameter approx. mm	Cable weight approx. kg/km	Copper index kg/km
2 x 2 x 0.8	1.0	8.0	85	25
4 x 2 x 0.8	1.0	9.6	130	45
8 x 2 x 0.8	1.0	12.4	205	85
12 x 2 x 0.8	1.0	13.0	255	126
16 x 2 x 0.8	1.0	14.0	310	166
20 x 2 x 0.8	1.2	15.8	385	206

ELECTRICAL CHARACTERISTICS

(Conductor) loop resistance max.	73.2 Ω/km
Insulation resistance min.	100 MΩ x km
Mutual capacitance (800 Hz) max.	120 nF/km 2 and 4 pair cable plus 20% permitted 1 pair 180nF/km
Capacitance unbalance (800 Hz) max.	200 pF/100m 20% of values, min. one value max. 400 pF
Test voltage core-core	500 V 50 Hz 1 min
Test voltage core-screen	2000 V 50 Hz 1 min
Peak operating voltage	225 V

THERMAL & MECHANICAL PROPERTIES

Temperature range moved	-5°C to +50°C
Temperature range static	-30°C to +70°C
Minimum bending radius	7.5 x diameter

Subject to changes due to technical progress and error



T.K. Kabel oHG · Geschwister-Scholl-Straße 11 · 71384 Weinstadt

Phone +49 (0) 7151/60 68 70 · Fax +49 (0) 7151/60 91 00 · info@tk-kabel.de · www.tk-kabel.de

A-H(St)HCHSOT Bd Si mtp*

in resemblance to DIN VDE 0815

* capable of maxi-termi-point

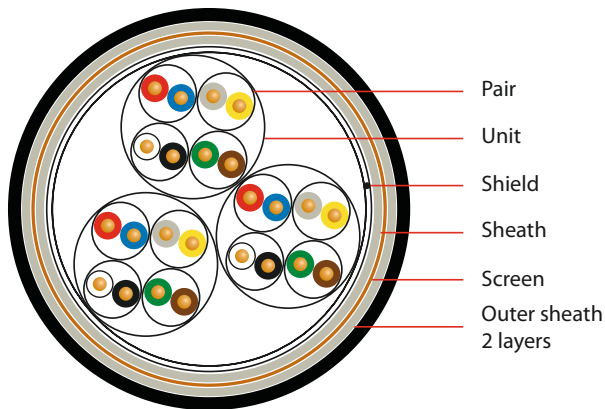

APPLICATION

This halogen-free, flame-resistant cable is used where increased fire protection of persons, material goods and buildings is required. It serves for signal transmission in communication systems with fixed installation. Not approved for power installation. Termite resistant. Appropriate for water installation.

CONSTRUCTION

Conductor: copper, solid, bare (Ø 0.8 mm)

Core insulation: halogen-free compound

Core stranding: 2 cores to pair, 4 pairs to unit, units in layers; 2 x 2 as star quad

Lapping: min. 2 layers of plastic foil

Shield: tinned drain wire (Ø 0.8 mm); plastic-laminated aluminium foil

Sheath: halogen-free compound

Screen: tinned copper wire braid (Ø 0.2 mm); optical coverage approx. 80 %

Outer sheath:

layer 1: halogen-free compound

layer 2: special halogen-free compound; termite protected; colour: black RAL 9005

BEHAVIOUR UNDER FIRE CONDITIONS

Zero halogen, non corrosive gases: IEC 60754-2, DIN EN 50267

Flame retardant: IEC 60332-1-2, DIN EN 60332-1-2

Fire retardant: IEC 60332-3-24, DIN EN 60332-3-24

Smoke density: IEC 61034, DIN EN 61034

Dimension	Sheath thickness approx. mm	Diameter approx. mm	Cable weight approx. kg/km	Copper index kg/km
2 x 2 x 0.8	1.4	9.7	160	65
4 x 2 x 0.8	1.4	11.5	210	95
8 x 2 x 0.8	1.8	14.8	340	153
12 x 2 x 0.8	1.8	15.8	400	197
20 x 2 x 0.8	1.8	18.3	560	294

ELECTRICAL CHARACTERISTICS

(Conductor) loop resistance max.	73.2 Ω/km
Insulation resistance min.	100 MΩ x km
Mutual capacitance (800 Hz) max.	120 nF/km 2 and 4 pair cable plus 20% permitted 1 pair 180nF/km
Capacitance unbalance (800 Hz) max.	200 pF/100m 20% of values, min. one value max. 400 pF
Test voltage core-core	500 V 50 Hz 1 min
Test voltage core-screen	2000 V 50 Hz 1 min
Peak operating voltage	225 V

THERMAL & MECHANICAL PROPERTIES

Temperature range during installation	-5°C to +50°C
Temperature range stationary	-30°C to +70°C
Minimum bending radius	10 x diameter

Subject to changes due to technical progress and error



T.K. Kabel oHG · Geschwister-Scholl-Straße 11 · 71384 Weinstadt
Phone +49 (0) 7151/60 68 70 · Fax +49 (0) 7151/60 91 00 · info@tk-kabel.de · www.tk-kabel.de

A-H(St)HDSHSOT Bd Si mtp*

in resemblance to DIN VDE 0815

* capable of maxi-termi-point

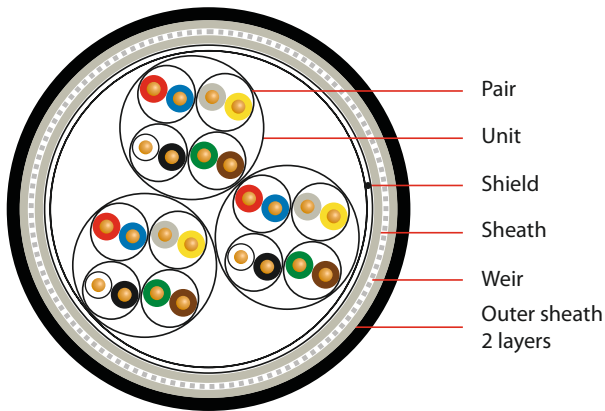
**APPLICATION**

This halogen-free, flame-resistant cable is used where increased fire protection of persons, material goods and buildings is required. It serves for signal transmission in communication systems with fixed installation. Not approved for power installation. Termite resistant and rodent proof. Appropriate for water installation.

CONSTRUCTION**Conductor:** copper, solid, bare (Ø 0.8 mm)**Core insulation:** halogen-free compound**Core stranding:** 2 cores to pair, 4 pairs to unit, units in layers; 2 x 2 as star quad**Lapping:** min. 2 layers of plastic foil**Shield:** tinned drain wire (Ø 0.8 mm); plastic-laminated aluminium foil**Sheath:** halogen-free compound**Weir / Rodent protection:** galvanized steel shield (Ø 0.9 mm or 1.4 mm); optical coverage approx. 80 %**Outer sheath:**

layer 1: halogen-free compound

layer 2: special halogen-free compound; termite protected; colour: black RAL 9005

BEHAVIOUR UNDER FIRE CONDITIONS

Zero halogen, non corrosive gases: IEC 60754-2, DIN EN 50267

Flame retardant: IEC 60332-1-2, DIN EN 60332-1-2

Fire retardant: IEC 60332-3-24, DIN EN 60332-3-24

Smoke density: IEC 61034, DIN EN 61034

Dimension	Sheath thickness approx. mm	Diameter approx. mm	Cable weight approx. kg/km	Copper index kg/km
2 x 2 x 0.8	1.4	11.0	235	26
4 x 2 x 0.8	1.4	13.0	315	46
8 x 2 x 0.8	1.8	16.7	482	87
12 x 2 x 0.8	1.8	17.3	545	129
16 x 2 x 0.8	1.8	18.2	627	170
20 x 2 x 0.8	1.8	20.5	748	211

ELECTRICAL CHARACTERISTICS

(Conductor) loop resistance max.	73.2 Ω/km
Insulation resistance min.	100 MΩ x km
Mutual capacitance (800 Hz) max.	120 nF/km 2 and 4 pair cable plus 20% permitted 1 pair 180nF/km
Capacitance unbalance (800 Hz) max.	200 pF/100m 20% of values, min. one value max. 400 pF
Test voltage core-core	500 V 50 Hz 1 min
Test voltage core-screen	2000 V 50 Hz 1 min
Peak operating voltage	225 V

THERMAL & MECHANICAL PROPERTIES

Temperature range during installation	-5°C to +50°C
Temperature range stationary	-30°C to +70°C
Minimum bending radius	10 x diameter

Subject to changes due to technical progress and error



T.K. Kabel oHG · Geschwister-Scholl-Straße 11 · 71384 Weinstadt

Phone +49 (0) 7151/60 68 70 · Fax +49 (0) 7151/60 91 00 · info@tk-kabel.de · www.tk-kabel.de

AJ-HCHDHSO Bd Si Cu16 mtp* Fca

in resemblance to DIN VDE 0815

* capable of maxi-termi-point

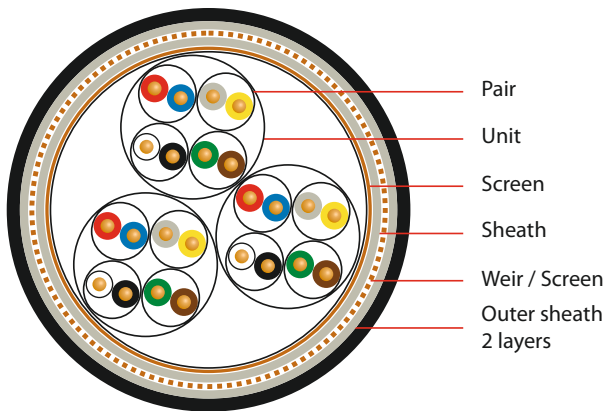

APPLICATION

This halogen-free, flame-resistant cable is used where increased fire protection of persons, material goods and buildings is required. It serves for signal transmission in communication systems with fixed installation. Not approved for power installation. Appropriate for water installation.

CONSTRUCTION

Core: copper solid, bare (Ø 0.8 mm)

Core insulation: halogen free compound

Core stranding: 2 cores to pair, 4 pairs to unit, units in layers; 2 x 2 as star quad

Lapping: plastic foil

Screen: tinned copper wire braid (Ø 0.2 mm)

Sheath: halogen free compound

Weir / Screen: cross section 16 mm²; surrounded with 16 bare copper wires (Ø 1.13 mm); lapping with plastic foil

Outer sheath:

Inner layer: halogen free compound;

Outer layer: halogen free special compound; colour: black RAL 9005

BEHAVIOUR UNDER FIRE CONDITIONS

Zero halogen, non corrosive gases: IEC 60754-2, DIN EN 50267

Flame retardant: IEC 60332-1-2, DIN EN 60332-1-2

Fire retardant: IEC 60332-3-24, DIN EN 60332-3-24

Smoke density: IEC 61034, DIN EN 61034

Dimension	Sheath thickness approx. mm	Diameter approx. mm	Cable weight approx. kg/km	Copper index kg/km
2 x 2 x 0.8	1.8	13.3	350	210
4 x 2 x 0.8	1.8	15.2	410	242
8 x 2 x 0.8	1.8	18.4	530	303
12 x 2 x 0.8	2.2	19.8	610	349

ELECTRICAL CHARACTERISTICS

(Conductor) loop resistance max.	73.2 Ω/km
Insulation resistance min.	100 MΩ x km
Mutual capacitance (800 Hz) max.	120 nF/km 2 and 4 pair cable plus 20% permitted 1 pair 180nF/km
Capacitance unbalance (800 Hz) max.	200 pF/100m 20% of values, min. one value max. 400 pF
Test voltage core-core	500 V 50 Hz 1 min
Test voltage core-screen	2000 V 50 Hz 1 min
Peak operating voltage	225 V

THERMAL & MECHANICAL PROPERTIES

Temperature range moved	-5°C to +50°C
Temperature range static	-30°C to +70°C
Minimum bending radius	15 x diameter

Subject to changes due to technical progress and error



T.K. Kabel oHG · Geschwister-Scholl-Straße 11 · 71384 Weinstadt

Phone +49 (0) 7151/60 68 70 · Fax +49 (0) 7151/60 91 00 · info@tk-kabel.de · www.tk-kabel.de



T.K. Kabel oHG

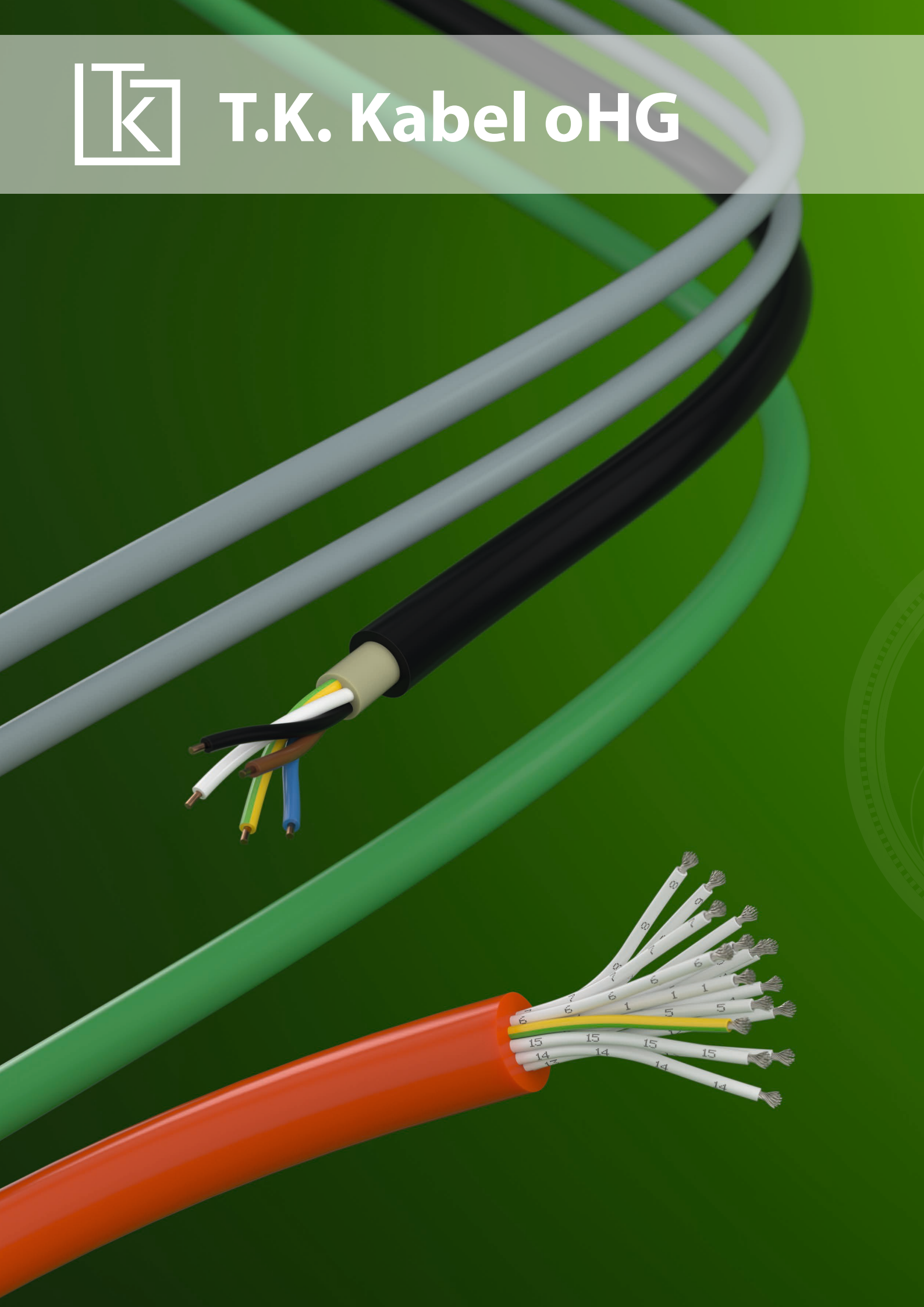

Measuring and control cables

RD-Y(St)Y Bd Eca
RD-H(St)H Bd Eca

64
65

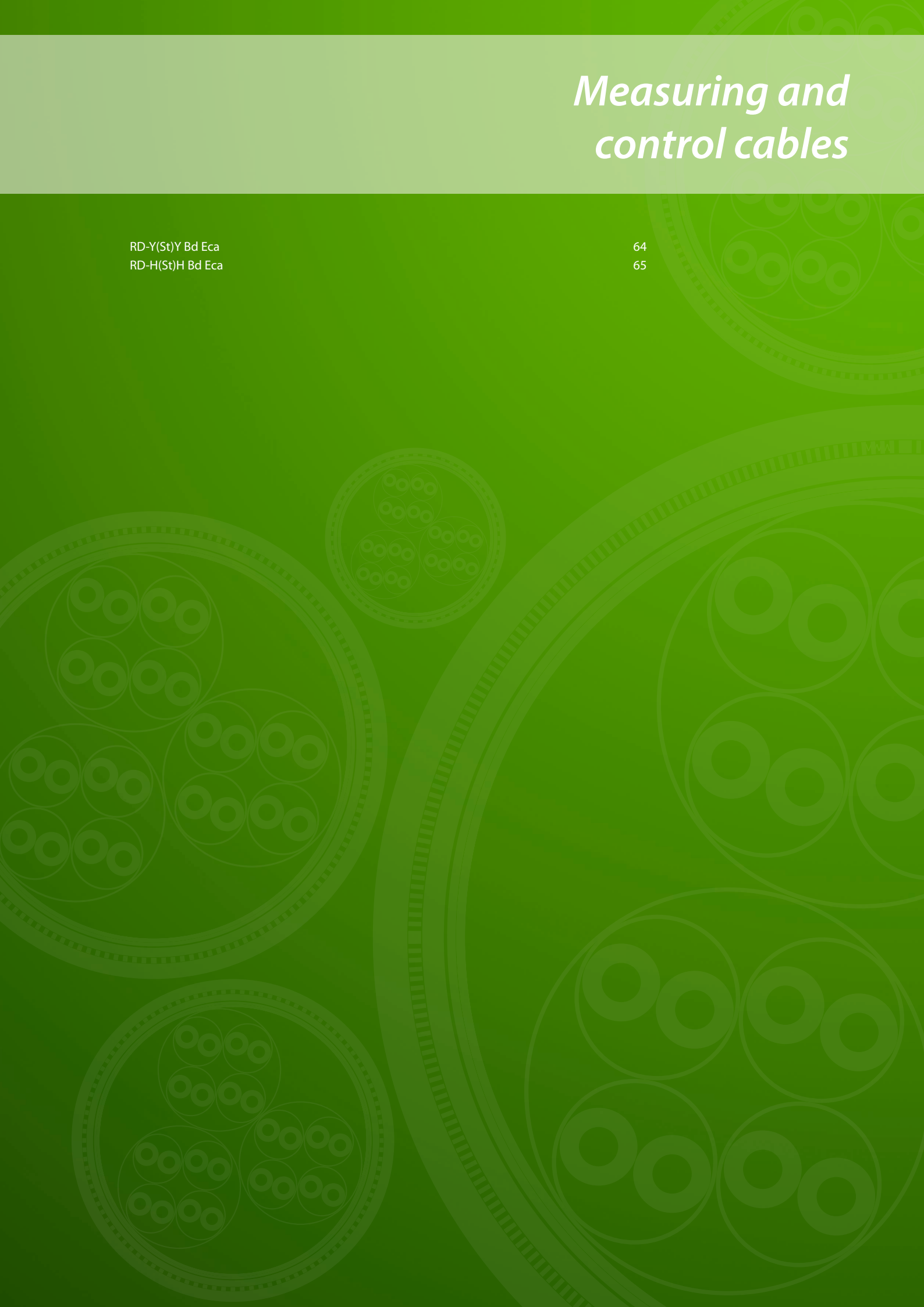

RD-Y(St)Y Bd Eca

construction and core identification
in resemblance to DIN VDE 0815

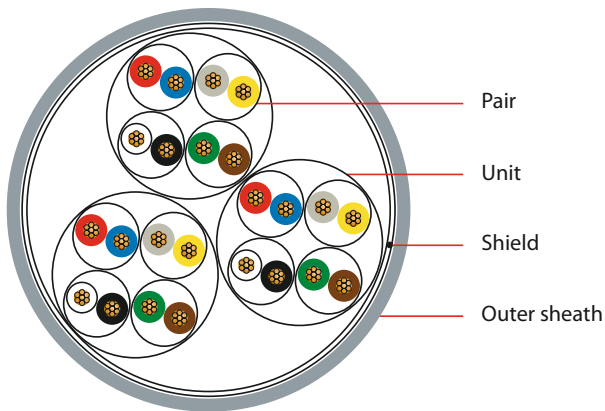

APPLICATION

As data transmission cable for transmission rates up to 10 kHz, mainly in power stations and other industrial plants.

Usage: For strong power grid not allowed, for underground laying not suitable, except solid laying

CONSTRUCTION

Conductor: copper strand, bare, flexible; 7 x 0.30 mm (Ø 0.9 mm)

Core insulation: PVC

Core stranding: 2 cores to pairs, 4 pairs to unit, units in layers

Lapping: plastic foil

Shield: tinned drain wire, 7 x 0.3 mm; plastic-laminated aluminium foil

Outer sheath: PVC; colour: grey RAL 7000

ELECTRICAL CHARACTERISTICS

(Conductor) loop resistance max.	78.4 Ω/km
Insulation resistance min. at 20°C	100 MΩ x km
Operating capacity (800 Hz) max.	100 nF/km
	120 nF/km (up to 4DA)
Capacitive coupling K1	200 pF/100m
	20% of values, min. one value max. 400 pF
Test voltage core-core	2000 V 50 Hz 1 min
Test voltage core-screen	2000 V 50 Hz 1 min
Peak operating voltage	600 V

BEHAVIOUR UNDER FIRE CONDITIONS

EN 50575; EN 60332-1-2; EN 13501-6 class Eca

CHEMICAL PROPERTIES

RoHS 2011/65/EU

Dimension	Sheath thickness approx. mm	Diameter approx. mm	Cable weight approx. kg/km	Copper index kg/km
1 x 2 x 0.5	1.0	5.4	40	15
2 x 2 x 0.5	1.0	6.2	55	25
4 x 2 x 0.5	1.0	8.1	90	45
8 x 2 x 0.5	1.0	11.1	160	85
12 x 2 x 0.5	1.0	12.6	225	125
16 x 2 x 0.5	1.2	14.0	280	165
20 x 2 x 0.5	1.2	14.8	335	205
24 x 2 x 0.5	1.2	16.0	390	245
32 x 2 x 0.5	1.4	19.0	525	325
40 x 2 x 0.5	1.4	20.8	635	405
48 x 2 x 0.5	1.4	22.0	740	485
80 x 2 x 0.5	1.8	30.0	1240	805
96 x 2 x 0.5	1.8	31.5	1450	965

THERMAL & MECHANICAL PROPERTIES

Temperature range during installation	-5°C to +50°C
Temperature range stationary	-30°C to +70°C
Minimum bending radius	8 x diameter

Subject to changes due to technical progress and error



RD-H(St)H Bd Eca

construction and core identification
in resemblance to DIN VDE 0815

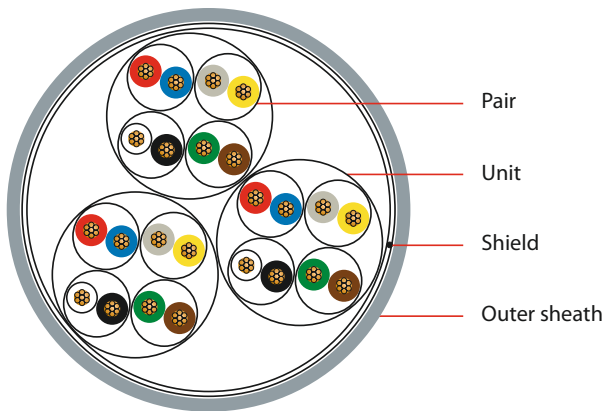

APPLICATION

As data transmission cable for transmission rates up to 10 kHz, mainly in power stations and other industrial plants.

CONSTRUCTION

Conductor: copper strand, bare, flexible

0.5 mm²: 7 x 0.3 mm (Ø 0.9 mm)

0.75 mm²: 7 x 0.37 mm (Ø 1.11 mm)

1.0 mm²: 7 x 0.43 mm (Ø 1.3 mm)

Core insulation: halogen-free compound

Core stranding: 4 pairs to unit, units in layers

Lapping: plastic foil

Screen: tinned drain wire, 7 x 0.3 mm;

plastic-laminated aluminium foil

Outer sheath: halogen-free compound; colour: grey RAL 7000

ELECTRICAL CHARACTERISTICS

(Conductor) loop resistance max. 0.5 mm² 78.4 Ω/km

(Conductor) loop resistance max. 0.75 mm² 52.3 Ω/km

(Conductor) loop resistance max. 1.0 mm² 36.8 Ω/km

Insulation resistance min. 100 MΩ x km

Char. Impedance (1 kHz) 0.5 mm² 370 Ω

Char. Impedance (1 kHz) 0.75 mm² 320 Ω

Char. Impedance (1 kHz) 1.0 mm² 260 Ω

Mutual capacitance (800 Hz) max. 120 nF/km
2 and 4 pair cable plus 20% permitted
1 pair 180nF/km

Capacitance unbalance (800 Hz) max. 200 pF/100m

Wave attenuation (1 KHz) 0.5 mm² 2.8 dB

Wave attenuation (1 KHz) 0.75 mm² 2.0 dB

Wave attenuation (1 KHz) 1.0 mm² 1.2 dB

Crosstalk attenuation (10 kHz) min. 60 dB/500 m

Test voltage core-core 2000 V 50 Hz 2 min

Test voltage core-screen 2000 V 50 Hz 2 min

Peak operating voltage 600 V

Dimension	Sheath thickness approx. mm	Diameter approx. mm	Cable weight approx. kg/km	Copper index kg/km
2 x 2 x 0.5	1.0	6.0	60	25
4 x 2 x 0.5	1.0	8.0	95	45
8 x 2 x 0.5	1.0	11.0	160	85
12 x 2 x 0.5	1.0	12.0	210	125
16 x 2 x 0.5	1.0	12.8	260	165
20 x 2 x 0.5	1.0	14.0	320	205
24 x 2 x 0.5	1.0	15.5	370	245
32 x 2 x 0.5	1.2	19.5	510	325
40 x 2 x 0.5	1.2	21.0	610	405
1 x 2 x 0.75	1.0	6.0	50	21
2 x 2 x 0.75	1.0	6.5	71	38
4 x 2 x 0.75	1.0	8.7	120	70
8 x 2 x 0.75	1.0	12.2	210	135
12 x 2 x 0.75	1.2	13.5	295	200
16 x 2 x 0.75	1.2	14.6	370	265
20 x 2 x 0.75	1.2	16.0	450	330
24 x 2 x 0.75	1.2	17.5	525	395
32 x 2 x 0.75	1.4	22.1	720	526
40 x 2 x 0.75	1.6	24.0	895	656
2 x 2 x 1.0	1.2	8.0	95	51
4 x 2 x 1.0	1.2	10.7	165	91
8 x 2 x 1.0	1.4	15.5	305	171
12 x 2 x 1.0	1.4	16.5	410	252
16 x 2 x 1.0	1.6	18.5	540	332
20 x 2 x 1.0	1.6	20.5	650	413
24 x 2 x 1.0	1.6	22.0	760	493
32 x 2 x 1.0	1.8	28.0	1030	654
40 x 2 x 1.0	2.0	30.0	1270	816

THERMAL & MECHANICAL PROPERTIES

Temperature range during installation -5°C to +50°C

Temperature range stationary -30°C to +70°C

Minimum bending radius 7.5 x diameter

BEHAVIOUR UNDER FIRE CONDITIONS

Zero halogen, non corrosive gases: IEC 60754-2, DIN EN 50267

Flame retardant: IEC 60332-1-2, DIN EN 60332-1-2

Fire retardant: IEC 60332-3-24, DIN EN 60332-3-24

Smoke density: IEC 61034, DIN EN 61034

Subject to changes due to technical progress and error



T.K. Kabel oHG · Geschwister-Scholl-Straße 11 · 71384 Weinstadt

Phone +49 (0) 7151/60 68 70 · Fax +49 (0) 7151/60 91 00 · info@tk-kabel.de · www.tk-kabel.de



T.K. Kabel oHG

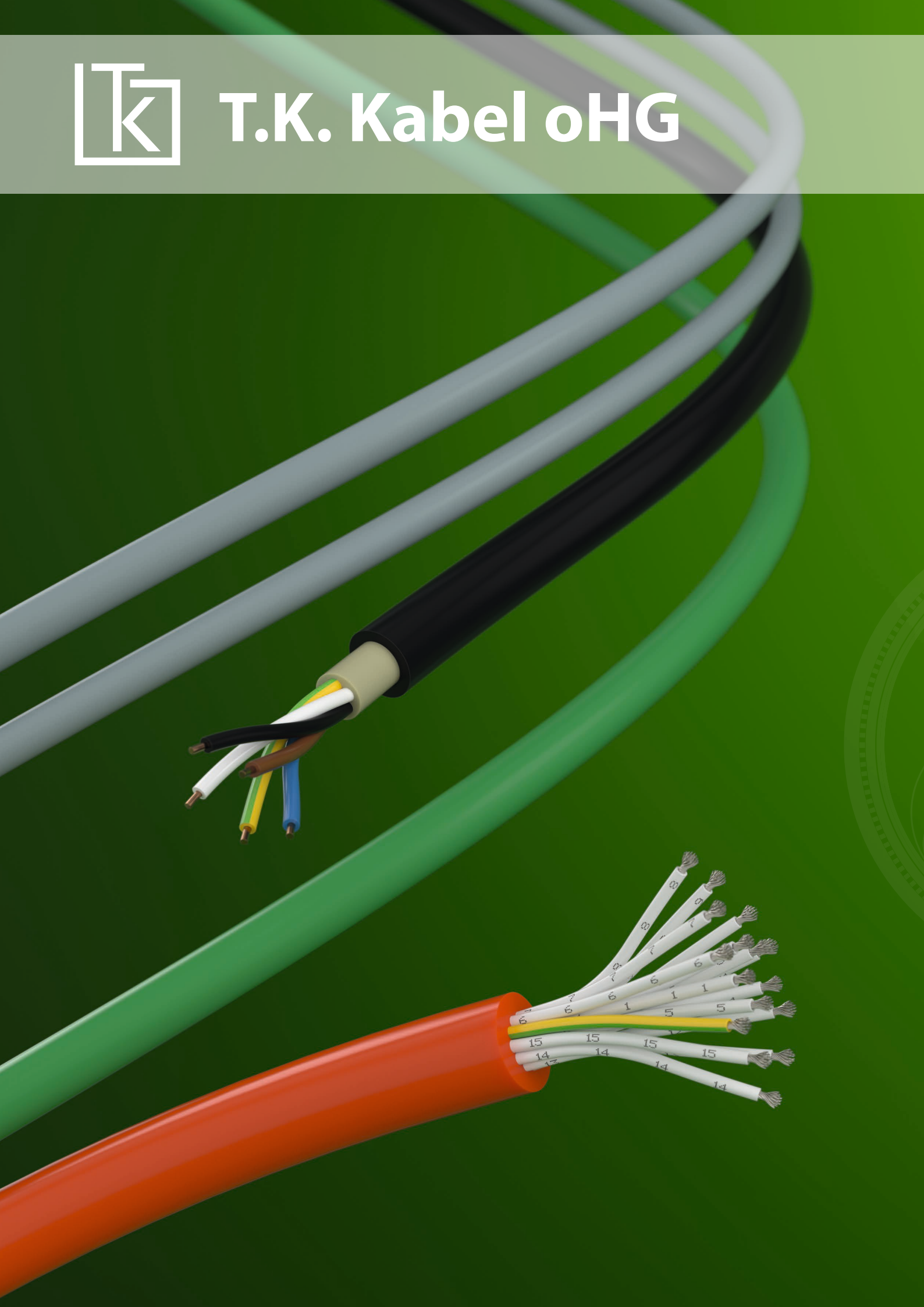

Bus cables

02YS(St)CY
02YS(St)CY2Y
02YSY(St)CY-FR
02YS(St)CH

68
69
70
71



02YS(St)CY

acc. to DIN 19245 T3 and EN 50170
(acc. Profibus specification)

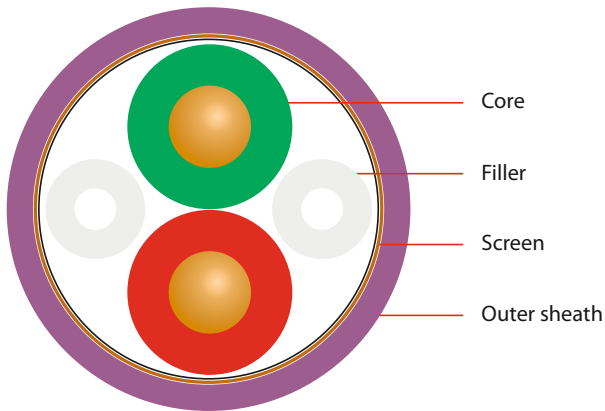

Dimension	Diameter approx. mm	Cable weight approx. kg/km	Copper index kg/km
1 x 2 x 0.64	7.5	54	25

APPLICATION

The cable can be used as connecting cable in general machinery construction. It is used as a connection cable between bus segments. Cost-efficient plant and machinery wiring is the great advantage of bus technology. Only the information-related component responds to the signal and processes it. The cable is appropriate for indoor installation.

CONSTRUCTION

- Conductor:** copper wire, solid, bare (AWG 22/1)
- Core insulation:** Foam-Skin PE
- Core identification:** red, green
- Core stranding:** 2 cores and 2 filling cores stranded
- Lapping:** plastic foil
- Screen:** Al/PETP compound foil; tinned copper wire braid; optical coverage approx. 80%
- Outer sheath:** PVC; colour: violet RAL 4001

ELECTRICAL CHARACTERISTICS

(Conductor) loop resistance max.	115 Ω/km
Insulation resistance min.	1 GΩ x km
Characteristic impedance (3 - 20MHz)	150 ± 15 Ω
Mutual capacitance nom.	30 nF/km
Attenuation max. at	
9.6 KHz	max. 2.5 dB/km
38.4 kHz	max. 4.0 dB/km
4.0 Mhz	max. 22.0 dB/km
16.0 Mhz	max. 42.0 dB/km
Peak operating voltage	250 V
Test voltage	1500 V

THERMAL & MECHANICAL PROPERTIES

Temperature range stationary	-30°C to +70°C
Minimum bending radius stationary	65 mm

Subject to changes due to technical progress and error



02YS(St)CY2Y

acc. to DIN 19245 T3 and EN 50170
(acc. Profibus specification)

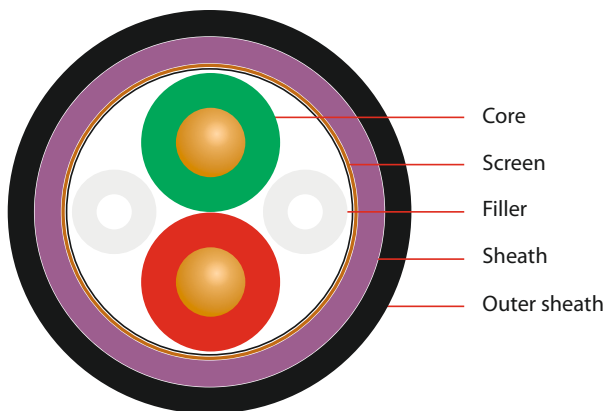

APPLICATION

The cable can be used as connecting cable in general machinery construction. It is used as a connection cable between bus segments. Cost-efficient plant and machinery wiring is the great advantage of bus technology. Only the information-related component responds to the signal and processes it. The cable is applicable for indoor and outdoor installation.

CONSTRUCTION

Conductor: copper wire, solid, bare (AWG 22/1)

Core insulation: Foam-Skin PE

Core identification: red, green

Core stranding: 2 cores and 2 filling cores stranded

Lapping: plastic foil

Screen: Al/PETP compound foil; tinned copper wire braid; optical coverage approx. 80%

Sheath: PVC; colour: violet RAL 4001

Outer sheath: PE; colour: black RAL 9005

Dimension	Diameter approx. mm	Cable weight approx. kg/km	Copper index kg/km
1 x 2 x 0.64	10.2	95	25

ELECTRICAL CHARACTERISTICS

(Conductor) loop resistance max.	115 Ω/km
Insulation resistance min.	1 GΩ x km
Characteristic impedance (3 - 20MHz)	150 ± 15 Ω
Mutual capacitance nom.	30 nF/km
Attenuation max. at	
9.6 KHz	max. 2.5 dB/km
38.4 kHz	max. 4.0 dB/km
4.0 Mhz	max. 22.0 dB/km
16.0 Mhz	max. 42.0 dB/km
Peak operating voltage	250 V
Test voltage	1500 V

THERMAL & MECHANICAL PROPERTIES

Temperature range stationary	-30°C to +70°C
Minimum bending radius stationary	120 mm

Subject to changes due to technical progress and error



02YSY(St)CY-FR

acc. to DIN 19245 T3 and EN 50170
(acc. Profibus specification)

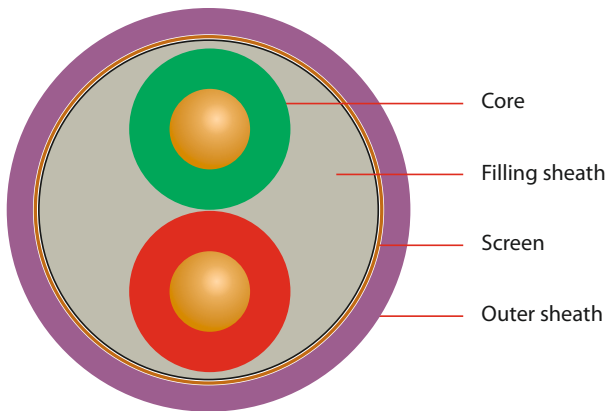

Dimension	Diameter approx. mm	Cable weight approx. kg/km	Copper index kg/km
1 x 2 x 0.64	7.8	70	25

APPLICATION

The cable can be used as connecting cable in general machinery construction. It is used as a connecting cable between bus segments. Cost-efficient plant and machinery wiring is the great advantage of bus technology. Only the information related component responds to the signal and processes it. Together with the appropriate tools and connectors the cable is appropriate for quick-assembly technology.

CONSTRUCTION

- Conductor:** copper wire, solid, bare (AWG 22/1)
- Core insulation:** Foam-Skin PE
- Core identification:** red, green
- Core stranding:** 2 cores stranded
- Filling sheath:** filling compound
- Lapping:** plastic foil
- Screen:** Al/PETP compound foil; tinned copper wire braid; optical coverage approx. 80%
- Outer sheath:** PVC-FR; colour: violet RAL 4001

BEHAVIOUR UNDER FIRE CONDITIONS

Fire retardant: IEC 60332-3-24, DIN EN 60332-3-24
Low smoke and fume

ELECTRICAL CHARACTERISTICS

(Conductor) loop resistance max.	115 Ω/km
Insulation resistance min.	1 GΩ x km
Characteristic impedance (3 - 20MHz)	150 ± 15 Ω
Mutual capacitance nom.	30 nF/km
Attenuation max. at	
9.6 KHz	max. 2.5 dB/km
38.4 kHz	max. 4.0 dB/km
4.0 Mhz	max. 22.0 dB/km
16.0 Mhz	max. 42.0 dB/km
Peak operating voltage	250 V
Test voltage	1500 V

THERMAL & MECHANICAL PROPERTIES

Temperature range stationary	-30°C to +70°C
Minimum bending radius stationary	80 mm

Subject to changes due to technical progress and error



02YS(St)CH

acc. to DIN 19245 T3 and EN 50170
(acc. Profibus specification)

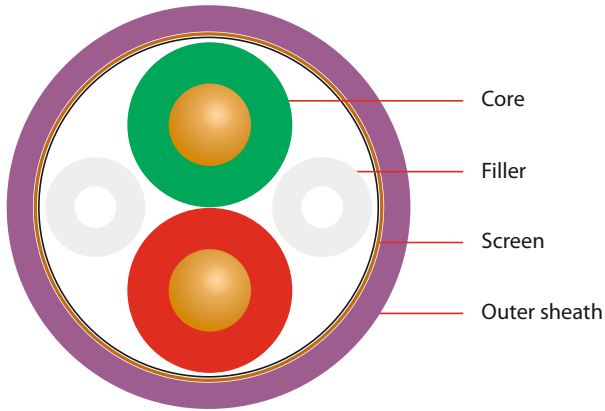

APPLICATION

The cable can be used as connecting cable in general machinery construction. It is used as a connection cable between bus segments. Cost-efficient plant and machinery wiring is the great advantage of bus technology. Only the information-related component responds to the signal and processes it. The cable is appropriate for indoor installation.

CONSTRUCTION

- Conductor:** copper wire, solid, bare (AWG 22/1)
- Core insulation:** Foam-Skin PE
- Core stranding:** 2 cores and 2 filling cores stranded
- Lapping:** plastic foil
- Screen:** Al/PETP compound foil; tinned copper wire braid; optical coverage approx. 80%
- Outer sheath:** halogen-free compound; colour: violet RAL 4001

Dimension	Diameter approx. mm	Cable weight approx. kg/km	Copper index kg/km
1 x 2 x 0.64	7.5	54	25

ELECTRICAL CHARACTERISTICS

(Conductor) loop resistance max.	115 Ω/km
Insulation resistance min.	1 GΩ x km
Characteristic impedance (3 - 20MHz)	150 ± 15 Ω
Mutual capacitance nom.	30 nF/km
Attenuation max. at	
9.6 KHz	max. 2.5 dB/km
38.4 kHz	max. 4.0 dB/km
4.0 Mhz	max. 22.0 dB/km
16.0 Mhz	max. 42.0 dB/km
Peak operating voltage	250 V
Test voltage	1500 V

THERMAL & MECHANICAL PROPERTIES

Temperature range stationary	-30°C to +70°C
Minimum bending radius stationary	65 mm

Subject to changes due to technical progress and error





T.K. Kabel oHG

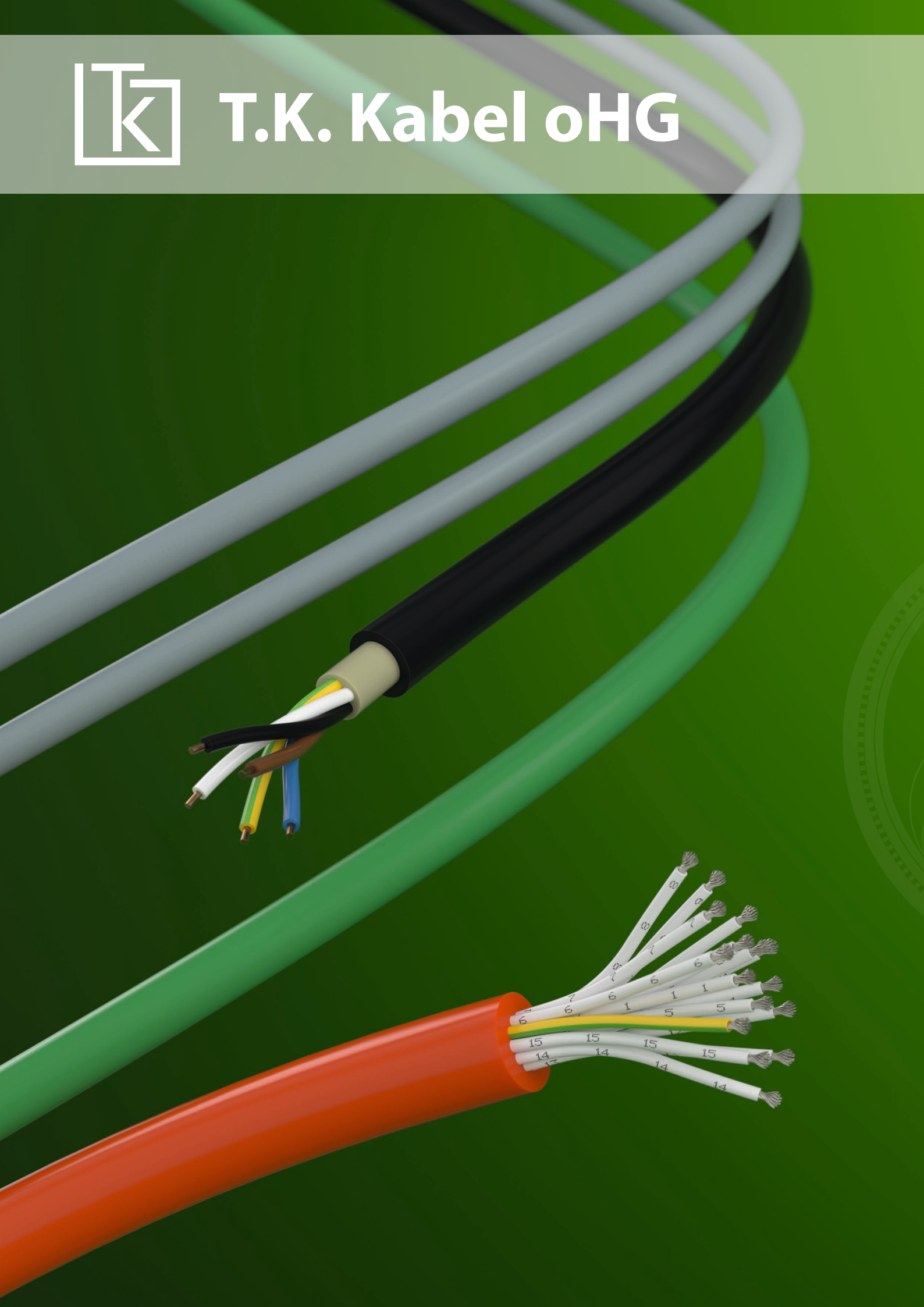

Control cables

LIYCY	74	LI6YC6Y-O/J n x 1.5 GY/BU/BK	95
YSLY-OZ/JZ	76	LI6YC6Y-O/J 3 x 2.5 BK	96
YSLCY-OZ/JZ	80	LI6YC6Y-O/J 4 x AWG 14 BK	97
HSLH-OZ/JZ	84	LI6YC6YS-O/J 3 x 2.5	98
LI7YC7Y n x 2 x 0.5 GY/BU	86	LI6YC6YS6Y-J 18 x 0.5 BK	99
LI7YC7Y n x 2 x 1.0 GY/BU	87	LI6YC6YS6Y-O/J n x 0.75 BK	100
LI7YC7YS7Y n x 2 x 0.5 GY/BU	88	LI6YC6YS6Y-O/J n x 1.5 BK	101
LI7YC7Y 2 x 1.5 BK	89	LISOSI 0.75	102
LI6Y 1 x 0.75	90	LISOSISOSI-O/J n x 1.5 BK	103
LI6YC6Y-O/J n x 0.75 GY/BU/BK	91	LISOSICSOSI n x 2 x 0.5 GY/BU	104
LI6YC6Y (4+2) x 0.75 GY/BU	92	LISOSICSOSI-O/J n x 0.75 GY/BU	105
LI6YC6Y-O 24 x 0.75 BK	93	LISOSICSOSI-O/J n x 1.5 GY/BU	106
LI6YC6Y-O/J 32 x 0.75 BK	94	LISOSICSOSI 4 x 1.5 + 3 x 0.38	107
		LISOSI51Y 1 x 1.5	108

LIYCY

in resemblance to DIN VDE 0812

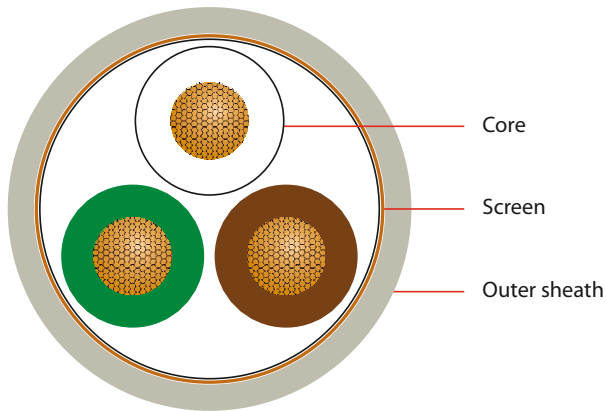

APPLICATION

Screened connecting and junction cable for measurement and control technology. Not approved for power and underground installation.

CONSTRUCTION

Conductor: copper strand, bare

Core insulation: PVC

Core identification: acc. to DIN 47100

Core stranding: cores twisted to layers

Lapping: plastic foil

Screen: tinned copper wire braid; optical coverage approx. 80 %

Outer sheath: PVC; colour: grey

ELECTRICAL CHARACTERISTICS

Cross-section	Bunched conductor	Conductor resist.
0.14 mm ²	18 x 0.10 mm	max. 148 Ω/km
0.25 mm ²	14 x 0.15 mm	max. 79.9 Ω/km
0.34 mm ²	7 x 0.25 mm	max. 57.5 Ω/km
0.50 mm ²	16 x 0.20 mm	max. 38.9 Ω/km
0.75 mm ²	24 x 0.20 mm	max. 26.0 Ω/km
1.00 mm ²	32 x 0.20 mm	max. 19.5 Ω/km
1.50 mm ²	30 x 0.25 mm	max. 13.3 Ω/km

Insulation resistance min. 20 MΩ x km

Peak operating voltage 0.14 mm² 350 V

Peak operating voltage rest 500 V

Test voltage 0.14 mm² 800 V

Test voltage rest 1200 V

THERMAL & MECHANICAL PROPERTIES

Temperature range during installation -5°C to +50°C

Temperature range stationary -30°C to +70°C

Dimension	Sheath thickness approx. mm	Diameter approx. mm	Cable weight approx. kg/km	Copper index kg/km
2 x 0.14	0.6	3.7	21	12.6
3 x 0.14	0.6	3.9	25	14.1
4 x 0.14	0.6	4.1	29	15.9
5 x 0.14	0.6	4.4	35	19.5
6 x 0.14	0.6	4.7	38	22
7 x 0.14	0.6	4.7	41	24
8 x 0.14	0.6	5.0	45	26
9 x 0.14	0.7	5.5	49	28
10 x 0.14	0.7	5.9	56	29
12 x 0.14	0.7	6.1	61	32
14 x 0.14	0.7	6.3	67	35
16 x 0.14	0.8	6.8	81	49
18 x 0.14	0.8	7.1	92	54
20 x 0.14	0.8	7.4	104	58
21 x 0.14	0.8	7.4	106	60
24 x 0.14	0.8	8.1	118	74
25 x 0.14	0.8	8.3	120	78
27 x 0.14	0.8	8.3	123	85
30 x 0.14	0.8	8.5	135	98
32 x 0.14	0.8	8.8	146	108
36 x 0.14	0.8	9.1	157	117
40 x 0.14	0.8	9.4	166	126
42 x 0.14	1.0	10.7	178	132
44 x 0.14	1.0	10.7	195	138
48 x 0.14	1.0	10.9	206	145
52 x 0.14	1.0	11.1	212	155
56 x 0.14	1.0	11.4	220	166
61 x 0.14	1.0	11.7	250	176
2 x 0.25	0.6	4.3	20	15
3 x 0.25	0.6	4.5	35	18
4 x 0.25	0.6	4.8	44	22
5 x 0.25	0.6	5.2	50	25
6 x 0.25	0.7	5.8	58	30
7 x 0.25	0.7	5.8	60	32
8 x 0.25	0.7	6.2	67	35
10 x 0.25	0.8	7.3	81	42
12 x 0.25	0.8	7.5	91	50
14 x 0.25	0.8	7.8	116	64
16 x 0.25	0.8	8.2	133	71
18 x 0.25	0.8	8.6	137	80
20 x 0.25	0.8	9.0	153	100
21 x 0.25	0.8	9.0	171	105
24 x 0.25	1.0	10.5	158	115
25 x 0.25	1.0	10.7	190	117

Subject to changes due to technical progress and error



T.K. Kabel oHG · Geschwister-Scholl-Straße 11 · 71384 Weinstadt

Phone +49 (0) 7151/60 68 70 · Fax +49 (0) 7151/60 91 00 · info@tk-kabel.de · www.tk-kabel.de

Dimension	Sheath thickness approx. mm	Diameter approx. mm	Cable weight approx. kg/km	Copper index kg/km
LIYCY				
27 x 0.25	1.0	10.7	200	120
30 x 0.25	1.0	11.0	214	132
32 x 0.25	1.0	11.4	227	138
36 x 0.25	1.0	11.8	250	152
40 x 0.25	1.0	12.2	289	164
42 x 0.25	1.0	12.7	295	172
44 x 0.25	1.0	13.1	300	180
48 x 0.25	1.0	13.3	310	209
52 x 0.25	1.0	13.6	340	234
56 x 0.25	1.0	14.0	360	259
61 x 0.25	1.2	14.8	385	287
2 x 0.34	0.6	4.7	33	17
3 x 0.34	0.6	4.9	41	21
4 x 0.34	0.6	5.5	48	25
5 x 0.34	0.7	6.0	58	30
6 x 0.34	0.7	6.4	64	36
7 x 0.34	0.7	6.4	70	42
8 x 0.34	0.8	7.1	93	45
10 x 0.34	0.8	8.1	110	63
12 x 0.34	0.8	8.3	120	70
14 x 0.34	0.8	8.7	140	78
16 x 0.34	0.8	9.2	147	87
18 x 0.34	1.0	10.2	172	108
20 x 0.34	1.0	10.7	189	124
21 x 0.34	1.0	10.7	196	127
24 x 0.34	1.0	11.7	229	140
27 x 0.34	1.0	11.9	235	151
30 x 0.34	1.0	12.3	260	162
32 x 0.34	1.0	12.8	275	171
36 x 0.34	1.0	13.2	295	188
40 x 0.34	1.0	13.7	330	208
2 x 0.5	0.6	5.2	42	29
3 x 0.5	0.7	5.7	55	35
4 x 0.5	0.7	6.1	68	45
5 x 0.5	0.8	6.8	82	50
6 x 0.5	0.8	7.4	104	59
7 x 0.5	0.8	7.4	109	68
8 x 0.5	0.8	7.9	123	75
10 x 0.5	0.8	9.1	135	93
12 x 0.5	0.8	9.4	160	107
16 x 0.5	1.0	10.9	210	129

Dimension	Sheath thickness approx. mm	Diameter approx. mm	Cable weight approx. kg/km	Copper index kg/km
LIYCY				
20 x 0.5	1.0	12.0	270	165
24 x 0.5	1.0	13.2	320	190
25 x 0.5	1.0	13.5	335	211
2 x 0.75	0.7	5.8	50	35
3 x 0.75	0.7	6.1	71	46
4 x 0.75	0.8	6.8	78	56
5 x 0.75	0.8	7.4	100	70
6 x 0.75	0.8	8.0	116	85
7 x 0.75	0.8	8.0	131	90
8 x 0.75	0.8	8.5	151	110
10 x 0.75	1.0	10.5	173	131
12 x 0.75	1.0	10.8	218	148
18 x 0.75	1.0	12.5	300	205
20 x 0.75	1.0	13.0	331	220
24 x 0.75	1.2	14.8	376	250
27 x 0.75	1.2	15.1	448	277
30 x 0.75	1.2	15.6	486	315
2 x 1.0	0.7	6.1	74	45
3 x 1.0	0.7	6.4	89	54
4 x 1.0	0.8	7.2	107	69
5 x 1.0	0.8	7.8	132	82
7 x 1.0	0.8	8.4	158	106
8 x 1.0	0.8	9.1	179	118
10 x 1.0	1.0	11.1	215	145
12 x 1.0	1.0	11.4	254	166
16 x 1.0	1.0	12.6	330	220
18 x 1.0	1.0	13.2	366	249
20 x 1.0	1.0	13.8	399	269
25 x 1.0	1.2	16.2	478	331
2 x 1.5	0.8	6.9	86	56
3 x 1.5	0.8	7.3	107	74
4 x 1.5	0.8	7.9	129	91
5 x 1.5	0.8	8.6	150	105
7 x 1.5	0.8	9.3	192	141
8 x 1.5	1.0	10.6	219	157
10 x 1.5	1.0	12.3	274	195
12 x 1.5	1.0	12.7	315	228
18 x 1.5	1.2	15.1	450	338
20 x 1.5	1.2	15.8	500	375
25 x 1.5	1.2	18.1	618	459

Subject to changes due to technical progress and error

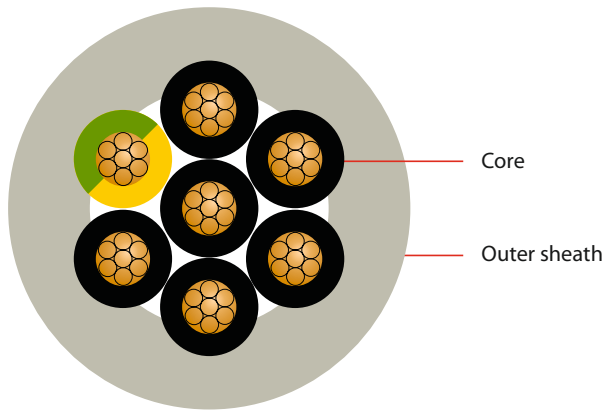

YSLY-OZ/JZ

**APPLICATION**

Plant manufacturing, power stations, data processing systems and others. Mainly for installation in dry, moist/wet rooms, especially in industrial environments, for average mechanical loads. No direct underground or water installation possible. For free, not constantly recurring movement, without tensile load or forced guidance, as well as for fixed installation. Resistant to UV radiation, acid, alkali and specific oils.

CONSTRUCTION

Conductor: copper strand, bare, fine-wired acc. to VDE 0295 class 5

Core insulation: special PVC insulation

Core identification: black with white numbers;

JZ: one core green-yellow in outer layer

Core stranding: cores twisted to layers

Outer sheath: special PVC-based compound;

colour: silver-grey RAL 7001 or black RAL 9005 (optional)

ELECTRICAL CHARACTERISTICS

Insulation resistance min.	20 MΩ x km
Nominal voltage U_0 / U	300/500 V
Test voltage	4000 V

THERMAL & MECHANICAL PROPERTIES

Temperature range during installation	0°C to +70°C
Temperature range stationary	-40°C to +80°C
Bending radius during installation min.	15 x Diameter
Bending radius stationary min.	4 x diameter

Dimension	Sheath thickness approx. mm	Diameter approx. mm	Cable weight approx. kg/km	Copper index kg/km
YSLY-OZ				
2 x 0.5	0.7	4.9	34	9.6
3 x 0.5	0.7	5.3	42	14.4
4 x 0.5	0.7	5.7	49	19.2
5 x 0.5	0.7	6.5	65	24
7 x 0.5	0.8	7.0	79	34
8 x 0.5	0.8	8.1	101	38
10 x 0.5	0.9	8.6	114	48
12 x 0.5	1.0	9.2	132	58
14 x 0.5	1.0	10.2	161	67
16 x 0.5	1.0	10.5	173	77
18 x 0.5	1.2	11.5	203	86
40 x 0.5	1.4	15.6	391	192
2 x 0.75	0.8	5.5	45	14.4
3 x 0.75	0.8	5.8	54	21.6
4 x 0.75	0.8	6.4	66	29
5 x 0.75	0.8	6.9	79	36
6 x 0.75	0.8	7.5	94	43.2
7 x 0.75	0.8	7.5	98	50
8 x 0.75	0.9	9.0	132	58
9 x 0.75	0.9	8.9	128	65
10 x 0.75	1.0	9.8	154	72
12 x 0.75	1.0	9.7	162	86
14 x 0.75	1.1	10.8	196	101
18 x 0.75	1.1	11.7	238	130
25 x 0.75	1.3	14.0	333	180
42 x 0.75	1.5	17.4	529	302
2 x 1	0.8	5.9	53	19.2
2 x 1.5	0.8	6.5	67	29
2 x 4	1.0	9.3	152	76.8
2 x 6	1.1	11.1	221	115.2

Subject to changes due to technical progress and error



T.K. Kabel oHG · Geschwister-Scholl-Straße 11 · 71384 Weinstadt

Phone +49 (0) 7151/60 68 70 · Fax +49 (0) 7151/60 91 00 · info@tk-kabel.de · www.tk-kabel.de

Dimension	Sheath thickness approx. mm	Diameter approx. mm	Cable weight approx. kg/km	Copper index kg/km
YSLY-JZ				
3 x 0.5	0.7	5.3	42	14.4
4 x 0.5	0.7	5.7	49	19.2
5 x 0.5	0.7	6.5	65	24
6 x 0.5	0.8	7.0	76	28.8
7 x 0.5	0.8	7.0	79	34
8 x 0.5	0.8	8.1	101	38
10 x 0.5	0.9	8.6	114	48
12 x 0.5	1.0	9.2	132	58
14 x 0.5	1.0	10.2	161	67
16 x 0.5	1.0	10.5	173	77
21 x 0.5	1.1	11.5	211	101
25 x 0.5	1.2	13.3	265	120
30 x 0.5	1.2	14.4	321	144
34 x 0.5	1.4	15.0	354	163
40 x 0.5	1.4	15.6	391	192
42 x 0.5	1.4	16.1	415	201.6
50 x 0.5	1.6	18.4	525	574
61 x 0.5	1.6	18.8	574	293
65 x 0.5	1.6	19.6	628	312
80 x 0.5	2.0	22.4	791	384
3 x 0.75	0.8	5.8	54	21.6
4 x 0.75	0.8	6.4	66	29
5 x 0.75	0.8	6.9	79	36
6 x 0.75	0.8	7.5	94	43.2
7 x 0.75	0.8	7.5	98	50
8 x 0.75	0.9	9.0	132	58
9 x 0.75	0.9	8.9	128	65
10 x 0.75	1.0	9.8	154	72
12 x 0.75	1.0	9.7	162	86
14 x 0.75	1.1	10.8	196	101
15 x 0.75	1.1	11.2	206	108
16 x 0.75	1.2	12.0	238	116
18 x 0.75	1.1	11.7	238	130
21 x 0.75	1.2	13.3	291	151
25 x 0.75	1.3	14.0	333	180
27 x 0.75	1.3	14.5	359	195
34 x 0.75	1.4	16.4	456	245
37 x 0.75	1.4	16.2	466	266.4
41 x 0.75	1.5	17.4	524	295
42 x 0.75	1.5	17.4	529	302
50 x 0.75	1.6	19.2	648	360
61 x 0.75	1.7	21.0	767	439

Dimension	Sheath thickness approx. mm	Diameter approx. mm	Cable weight approx. kg/km	Copper index kg/km
YSLY-JZ				
65 x 0.75	2.0	22.1	835	468
80 x 0.75	2.0	24.3	1015	576
3 x 1	0.8	6.2	63	29
4 x 1	0.8	6.7	77	38
5 x 1	0.8	7.3	94	48
6 x 1	0.9	8.2	115	58
7 x 1	0.9	8.2	121	67
8 x 1	0.9	8.8	136	77
9 x 1	1.0	9.8	161	86
10 x 1	1.0	10.0	176	96
14 x 1	1.1	11.5	237	134
16 x 1	1.1	12.0	262	154
18 x 1	1.2	12.9	300	173
19 x 1	1.2	13.0	309	182.4
20 x 1	1.3	13.8	340	192
21 x 1	1.3	13.7	339	202
25 x 1	1.3	14.9	401	240
26 x 1	1.3	14.9	408	250
27 x 1	1.3	14.9	414	260
34 x 1	1.5	17.2	547	326
36 x 1	1.5	17.6	568	345.6
37 x 1	1.6	17.3	561	355.2
41 x 1	1.6	19.1	660	394
42 x 1	1.6	19.1	666	403
50 x 1	1.7	21.0	795	480
61 x 1	1.8	22.1	914	586
65 x 1	2.0	23.5	1007	624
3 x 1.5	0.8	6.9	82	43
4 x 1.5	0.8	7.4	100	58
5 x 1.5	0.9	8.3	125	72
6 x 1.5	0.9	9.1	149	86.4
7 x 1.5	0.9	9.1	158	101
8 x 1.5	1.0	9.9	179	115
9 x 1.5	1.0	12.0	249	130
10 x 1.5	1.1	11.0	224	144
11 x 1.5	1.2	12.2	263	158
12 x 1.5	1.1	11.7	263	173
14 x 1.5	1.2	12.9	311	202
16 x 1.5	1.2	13.4	342	230
18 x 1.5	1.3	14.7	399	259
19 x 1.5	1.3	14.7	408	273.6

Subject to changes due to technical progress and error



Dimension	Sheath thickness approx. mm	Diameter approx. mm	Cable weight approx. kg/km	Copper index kg/km	Dimension	Sheath thickness approx. mm	Diameter approx. mm	Cable weight approx. kg/km	Copper index kg/km
YSLY-JZ					YSLY-JZ				
20 x 1.5	1.5	15.7	453	288	3 x 16	1.5	18.0	720	460.8
21 x 1.5	1.4	15.5	450	302	4 x 16	1.5	19.6	891	614
25 x 1.5	1.5	16.9	544	360	5 x 16	1.7	21.7	1103	768
27 x 1.5	1.5	16.9	552	388.8	7 x 16	1.8	24.2	1435	1075
32 x 1.5	1.6	19.3	695	461					
34 x 1.5	1.6	19.7	726	490	4 x 25	1.8	24.0	1357	960
41 x 1.5	1.7	21.5	870	591	5 x 25	2.0	27.0	1698	1200
42 x 1.5	1.8	21.6	865	605	7 x 25	2.2	29.7	2191	1680
50 x 1.5	1.9	23.9	1065	720					
61 x 1.5	2.1	25.6	1252	878	4 x 35	2.0	27.2	1815	1344
65 x 1.5	2.1	26.0	1303	936	5 x 35	2.2	30.4	2255	1680
80 x 1.5	2.5	29.8	1669	1152					
					4 x 50	2.5	35.4	2793	1920
3 x 2.5	0.9	8.3	126	72					
4 x 2.5	0.9	9.0	156	96	4 x 70	3.0	41.8	3888	2688
5 x 2.5	1.0	10.1	196	120					
7 x 2.5	1.1	11.3	254	168					
8 x 2.5	1.3	13.5	348	192					
9 x 2.5	1.4	13.8	346	216					
10 x 2.5	1.3	14.6	393	240					
12 x 2.5	1.3	14.7	426	288					
14 x 2.5	1.4	16.1	505	336					
18 x 2.5	1.5	18.1	641	432					
25 x 2.5	1.7	20.8	856	600					
34 x 2.5	2.0	24.6	1181	816					
42 x 2.5	2.3	27.4	1466	1008					
50 x 2.5	2.4	30.1	1750	1200					
3 x 4	1.0	10.1	194	115.2					
4 x 4	1.1	11.0	241	154					
5 x 4	1.2	12.3	301	192					
7 x 4	1.3	13.6	389	269					
12 x 4	1.6	17.8	654	460.8					
3 x 6	1.1	11.6	272	172.8					
4 x 6	1.2	12.8	337	230					
5 x 6	1.3	14.3	421	288					
7 x 6	1.4	15.7	553	403					
3 x 10	1.3	14.7	448	288					
4 x 10	1.4	16.3	569	384					
5 x 10	1.5	18.2	707	480					
7 x 10	1.6	20.0	917	672					

Subject to changes due to technical progress and error





T.K. Kabel oHG



T.K. Kabel oHG · Geschwister-Scholl-Straße 11 · 71384 Weinstadt

Phone +49 (0) 7151/60 68 70 · Fax +49 (0) 7151/60 91 00 · info@tk-kabel.de · www.tk-kabel.de

YSLCY-OZ/JZ

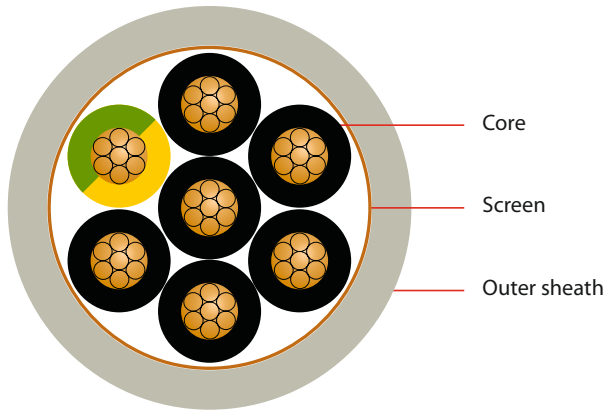

APPLICATION

Screened control cable for low mechanical loads.

CONSTRUCTION

Conductor: copper strand, bare. acc. to VDE 0295 class 5

Core insulation: PVC

Core identification: black with white numbers or coloured acc. to VDE 0293; JZ: one core green-yellow in outer layer

Core stranding: cores twisted to layers

Lapping: plastic foil

Screen: tinned copper wire braid; optical coverage approx. 80 %

Outer sheath: PVC; colour: grey RAL 7001

ELECTRICAL CHARACTERISTICS

Insulation resistance min.	20 MΩ x km
Nominal voltage U_0 / U	300/500 V
Test voltage core-core	2000 V
Test voltage core-screen	1000 V

THERMAL & MECHANICAL PROPERTIES

Temperature range during installation	-5°C to +50°C
Temperature range stationary	-30°C to +70°C
Minimum bending radius	10 x diameter

Dimension	Sheath thickness approx. mm	Diameter approx. mm	Cable weight approx. kg/km	Copper index kg/km
YSLCY-OZ				
2 x 0.5	0.7	5.4	45	29
3 x 0.5	0.7	5.7	56	35
4 x 0.5	0.8	6.3	72	46
5 x 0.5	0.8	6.8	89	51
7 x 0.5	0.9	7.6	125	68
10 x 0.5	1.0	9.5	155	93
12 x 0.5	1.0	9.8	200	101
18 x 0.5	1.2	11.9	255	133
20 x 0.5	1.2	12.4	285	165
25 x 0.5	1.3	14.1	350	211
2 x 0.75	0.8	6.0	56	38
3 x 0.75	0.8	6.3	71	48
4 x 0.75	0.8	6.8	95	58
5 x 0.75	0.9	7.6	155	72
7 x 0.75	0.9	8.2	168	90
10 x 0.75	1.1	10.7	215	131
12 x 0.75	1.1	11.0	232	148
15 x 0.75	1.2	12.3	288	171
18 x 0.75	1.2	12.9	315	205
20 x 0.75	1.3	13.6	368	220
21 x 0.75	1.3	13.6	382	233
25 x 0.75	1.4	15.5	435	269
32 x 0.75	1.5	17.0	496	333
34 x 0.75	1.6	17.8	527	346
40 x 0.75	1.6	18.3	615	395
2 x 1	0.8	6.3	84	46
3 x 1	0.8	6.6	110	57
4 x 1	0.8	7.2	130	72
5 x 1	0.9	8.0	156	84
7 x 1	0.9	8.6	192	109
10 x 1	1.1	11.3	240	151
12 x 1	1.2	11.8	285	171
15 x 1	1.2	13.0	335	212
18 x 1	1.3	13.8	395	253
20 x 1	1.3	14.4	525	305
25 x 1	1.5	16.8	656	354
30 x 1	1.5	17.4	670	397
32 x 1	1.6	18.2	710	421
34 x 1	1.6	18.8	755	454
50 x 1	1.9	22.4	995	662

Subject to changes due to technical progress and error



T.K. Kabel oHG · Geschwister-Scholl-Straße 11 · 71384 Weinstadt

Phone +49 (0) 7151/60 68 70 · Fax +49 (0) 7151/60 91 00 · info@tk-kabel.de · www.tk-kabel.de

Dimension	Sheath thickness approx. mm	Diameter approx. mm	Cable weight approx. kg/km	Copper index kg/km	Dimension	Sheath thickness approx. mm	Diameter approx. mm	Cable weight approx. kg/km	Copper index kg/km
YSLCY-OZ					YSLCY-JZ				
2 x 1.5	0.8	6.9	97	58	3 x 0.5	0.7	5.7	56	35
3 x 1.5	0.9	7.5	125	77	4 x 0.5	0.8	6.3	72	46
4 x 1.5	0.9	8.1	165	94	5 x 0.5	0.8	6.8	89	51
5 x 1.5	1.0	9.0	193	114	7 x 0.5	0.9	7.6	125	68
7 x 1.5	1.0	9.7	245	146	10 x 0.5	1.0	9.5	155	93
10 x 1.5	1.2	12.7	310	201	12 x 0.5	1.0	9.8	200	101
12 x 1.5	1.3	13.3	365	241	18 x 0.5	1.2	11.9	255	133
15 x 1.5	1.4	14.8	465	296	20 x 0.5	1.2	12.4	285	165
18 x 1.5	1.4	15.5	553	355	25 x 0.5	1.3	14.1	350	211
20 x 1.5	1.5	16.4	595	401					
25 x 1.5	1.7	19.1	734	498	3 x 0.75	0.8	6.3	71	48
30 x 1.5	1.7	19.7	855	572	4 x 0.75	0.8	6.8	95	58
32 x 1.5	1.8	20.6	910	604	5 x 0.75	0.9	7.6	155	72
34 x 1.5	1.8	21.3	963	642	7 x 0.75	0.9	8.2	168	90
50 x 1.5	2.1	25.3	1330	926	10 x 0.75	1.1	10.7	215	131
					12 x 0.75	1.1	11.0	232	148
2 x 2.5	0.9	8.3	164	92	15 x 0.75	1.2	12.3	288	171
3 x 2.5	1.0	9.0	188	118	18 x 0.75	1.2	12.9	315	205
4 x 2.5	1.0	9.7	236	147	20 x 0.75	1.3	13.6	368	220
5 x 2.5	1.1	11.0	270	176	21 x 0.75	1.3	13.6	382	233
7 x 2.5	1.2	12.1	340	253	25 x 0.75	1.4	15.5	435	269
					32 x 0.75	1.5	17.0	496	333
2 x 4	1.0	10.0	194	135	34 x 0.75	1.6	17.8	527	346
3 x 4	1.1	10.8	250	178	40 x 0.75	1.6	18.3	615	395
4 x 4	1.2	11.9	302	220					
5 x 4	1.2	13.0	370	270	3 x 1	0.8	6.6	110	57
6 x 4	1.3	14.3	424	315	4 x 1	0.8	7.2	130	72
7 x 4	1.3	14.3	473	355	5 x 1	0.9	8.0	156	84
					7 x 1	0.9	8.6	192	109
3 x 6	1.2	12.4	300	220	10 x 1	1.1	11.3	240	151
4 x 6	1.3	13.7	400	284	12 x 1	1.2	11.8	285	171
5 x 6	1.4	13.1	500	370	15 x 1	1.2	13.0	335	212
7 x 6	1.5	16.8	650	490	18 x 1	1.3	13.8	395	253
					20 x 1	1.3	14.4	525	305
3 x 10	1.4	15.6	480	371	25 x 1	1.5	16.8	656	354
4 x 10	1.6	17.6	750	472	30 x 1	1.5	17.4	670	397
5 x 10	1.7	19.4	850	581	32 x 1	1.6	18.2	710	421
7 x 10	1.8	21.3	1250	781	34 x 1	1.6	18.8	755	454
					50 x 1	1.9	22.4	995	662

Subject to changes due to technical progress and error



Dimension	Sheath thickness approx. mm	Diameter approx. mm	Cable weight approx. kg/km	Copper index kg/km	Dimension	Sheath thickness approx. mm	Diameter approx. mm	Cable weight approx. kg/km	Copper index kg/km
YSLCY-JZ									
3 x 1.5	0.9	7.5	125	77					
4 x 1.5	0.9	8.1	165	94					
5 x 1.5	1.0	9.0	193	114					
7 x 1.5	1.0	9.7	245	146					
10 x 1.5	1.2	12.7	310	201					
12 x 1.5	1.3	13.3	365	241					
15 x 1.5	1.4	14.8	465	296					
18 x 1.5	1.4	15.5	553	355					
20 x 1.5	1.5	16.4	595	401					
25 x 1.5	1.7	19.1	734	498					
30 x 1.5	1.7	19.7	855	572					
32 x 1.5	1.8	20.6	910	604					
34 x 1.5	1.8	21.3	963	642					
50 x 1.5	2.1	25.3	1330	926					
3 x 2.5	1.0	9.0	188	118					
4 x 2.5	1.0	9.7	236	147					
5 x 2.5	1.1	11.0	270	176					
7 x 2.5	1.2	12.1	340	253					
3 x 4	1.1	10.8	250	178					
4 x 4	1.2	11.9	302	220					
5 x 4	1.2	13.0	370	270					
6 x 4	1.3	14.3	424	315					
7 x 4	1.3	14.3	473	355					
3 x 6	1.2	12.4	300	220					
4 x 6	1.3	13.7	400	284					
5 x 6	1.4	13.1	500	370					
7 x 6	1.5	16.8	650	490					
3 x 10	1.4	15.6	480	371					
4 x 10	1.6	17.6	750	472					
5 x 10	1.7	19.4	850	581					
7 x 10	1.8	21.3	1250	781					

Subject to changes due to technical progress and error





T.K. Kabel oHG



T.K. Kabel oHG · Geschwister-Scholl-Straße 11 · 71384 Weinstadt

Phone +49 (0) 7151/60 68 70 · Fax +49 (0) 7151/60 91 00 · info@tk-kabel.de · www.tk-kabel.de

HSLH-OZ/JZ

acc. to DIN EN 50267/IEC 60754

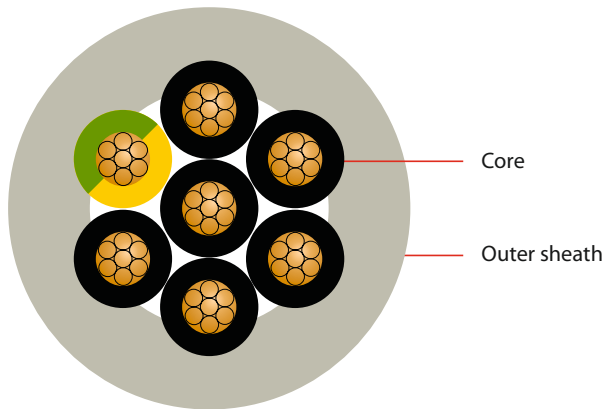

APPLICATION

Halogen-free and LSOH control cable for multiple purposes in control and measurement circuits with increased requirements to electro-magnetic compatibility.

CONSTRUCTION

Conductor: fine stranded bare copper, class 5

Core insulation: halogen-free compound HI2

Core identification: black with white numbers;

JZ: one core green-yellow in outer layer

Core stranding: cores twisted to layers

Outer sheath: halogen-free compound HM2; colour: grey RAL 7001

BEHAVIOUR UNDER FIRE CONDITIONS

Flame retardant acc. to VDE 0482-266-2-4/IEC 60332-3-24

Halogen-free acc. to DIN EN 50167/IEC 60754

ELECTRICAL CHARACTERISTICS

Nominal voltage U_0 / U 300/500 V

THERMAL & MECHANICAL PROPERTIES

Temperature range during installation -5°C to +50°C

Temperature range stationary -30°C to +70°C

Dimension	Sheath thickness approx. mm	Diameter approx. mm	Cable weight approx. kg/km	Copper index kg/km
HSLH-OZ				
2 x 0.5		5.1	38	9.6
2 x 0.75		5.5	33	14.4
2 x 1		5.7	58	19.2
2 x 1.5		6.3	87	29
2 x 2.5		7.7	124	48
2 x 4		9.8	195	77
2 x 6		12.0	258	115.2
2 x 10		15.0	490	192
2 x 16		17.3	665	307
HSLH-JZ				
3 x 0.75		6.0	66	22
4 x 0.75		6.5	78	29
5 x 0.75		7.0	91	36
7 x 0.75		7.5	124	50.4
12 x 0.75		10.2	191	86.4
18 x 0.75		11.9	283	130
25 x 0.75		14.6	388	180
34 x 0.75		16.4	641	245
37 x 0.75		17.2	795	260
41 x 0.75		17.6	800	296
42 x 0.75		17.8	715	302
50 x 0.75		19.8	815	360
61 x 0.75		20.9	1028	439
3 x 1		6.4	68	29
4 x 1		7.0	85	38.4
5 x 1		7.8	110	48
7 x 1		8.1	148	67
8 x 1		9.4	200	77
10 x 1		10.4	245	96
12 x 1		11.1	232	115.2
16 x 1		12.0	363	154
18 x 1		13.4	328	173
20 x 1		13.5	438	192
25 x 1		16.2	531	240
34 x 1		17.4	688	326
37 x 1		18.4	833	355
41 x 1		18.9	925	394
42 x 1		18.9	835	403
50 x 1		21.0	978	480

Subject to changes due to technical progress and error



T.K. Kabel oHG · Geschwister-Scholl-Straße 11 · 71384 Weinstadt

Phone +49 (0) 7151/60 68 70 · Fax +49 (0) 7151/60 91 00 · info@tk-kabel.de · www.tk-kabel.de

Dimension	Sheath thickness approx. mm	Diameter approx. mm	Cable weight approx. kg/km	Copper index kg/km	Dimension	Sheath thickness approx. mm	Diameter approx. mm	Cable weight approx. kg/km	Copper index kg/km
HSLH-JZ					HSLH-JZ				
3 x 1.5		7.3	95	43.2	3 x 10		16.2	750	288
4 x 1.5		7.8	117	58	4 x 10		18.0	746	384
5 x 1.5		8.9	152	72	5 x 10		19.8	917	480
7 x 1.5		9.8	192	101	7 x 10		22.5	1283	672
8 x 1.5		10.6	278	115					
10 x 1.5		11.7	309	144	3 x 16		18.7	998	461
12 x 1.5		13.2	312	173	4 x 16		20.6	1089	614
16 x 1.5		13.8	415	230	5 x 16		23.5	1285	768
18 x 1.5		15.9	456	259	7 x 16		26.2	1835	1075
20 x 1.5		15.2	585	288					
25 x 1.5		19.2	638	360	3 x 25		24.5	1238	720
34 x 1.5		19.8	890	490	4 x 25		26.0	1582	960
37 x 1.5		20.2	1140	533	5 x 25		30.8	1920	1200
50 x 1.5		23.7	1410	720					
61 x 1.5		25.3	1630	878	3 x 35		29.8	1664	1008
65 x 1.5		26.0	1810	936	4 x 35		33.7	1980	1344
					5 x 35		37.7	2765	1680
3 x 2.5		9.0	148	72					
4 x 2.5		10.0	236	96	3 x 50		33.8	2678	1440
5 x 2.5		11.0	263	120	4 x 50		38.0	2824	1920
7 x 2.5		12.7	298	168	5 x 50		42.1	4133	2400
8 x 2.5		13.2	378	192					
10 x 2.5		14.7	444	240	3 x 70		40.2	3339	2016
12 x 2.5		16.5	522	288	4 x 70		44.2	4295	2688
16 x 2.5		17.5	730	384	5 x 70		48.5	5715	3360
18 x 2.5		18.4	749	432					
20 x 2.5		18.7	1070	480	3 x 95		46.6	4914	2736
25 x 2.5		21.8	1024	600	4 x 95		51.2	5817	3648
30 x 2.5		23.7	1280	720	5 x 95		56.3	7278	4560
3 x 4		11.8	235	115	3 x 120		49.8	5515	3456
4 x 4		11.7	305	154	4 x 120		54.8	7350	4608
5 x 4		13.2	363	192					
7 x 4		16.0	468	269					
8 x 4		17.8	603	307					
10 x 4		19.6	798	384					
12 x 4		20.2	984	461					
16 x 4		22.8	1350	614					
3 x 6		12.7	390	173					
4 x 6		14.1	465	230					
5 x 6		16.5	583	288					
7 x 6		17.6	782	403					

Subject to changes due to technical progress and error



LI7YC7Y n x 2 x 0.5 GY/BU

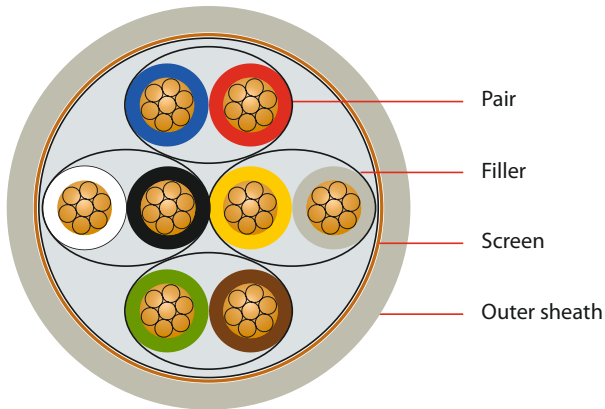

No. of cores and cross section	Sheath thickness approx. mm	Diameter approx. mm	Cable weight approx. kg/km	Copper index kg/km
2 x 2 x 0.5	0.4	6.2	73	30
4 x 2 x 0.5	0.4	7.6	114	65,2
8 x 2 x 0,5	0.5	9.8	241	118
12 x 2 x 0.5	0.5	11.5	283	163

APPLICATION

- in heat-appliances and fire resistant installations
- in the lighting and automobile sector
- for sensor applications
- plants in industrial atmosphere
- in the chemical industry

CONSTRUCTION

- Conductor:** tinned copper strand; $16 \times 0.2 \text{ mm} = 0.5 \text{ mm}^2$
- Core insulation:** ETFE; wall thickness 0.25 mm; approx. $\varnothing 1.45 \text{ mm}$
- Core identification:** colours acc. VDE 0815 or customer request
 12 x 2 x 0.5: black - white, brown - white, green - white, grey - white, blue - white, yellow - white, red - white, black - red, green - red, blue - red, yellow -red, grey - red
- Core stranding:** 2 cores to pair
- Filler:** silicone rubber (round shaping);
 8 x 2 x 0.5 and 12 x 2 x 0.5 without filler
- Screen:** tinned copper wire braid; optical coverage approx. 85 %
- Outer sheath:** ETFE; colour: grey (GY) or blue (BU)

ELECTRICAL CHARACTERISTICS

Test voltage	2500 V
Operating capacitance	80 nF/km
Inductance (reference values)	< 1 mH/km

THERMAL & MECHANICAL PROPERTIES

Operating temperature	-90°C to +155°C
-----------------------	-----------------

BEHAVIOUR UNDER FIRE CONDITIONS

Flame retardant:	IEC 60332-1-2
------------------	---------------

Subject to changes due to technical progress and error



LI7YC7Y n x 2 x 1.0 GY/BU

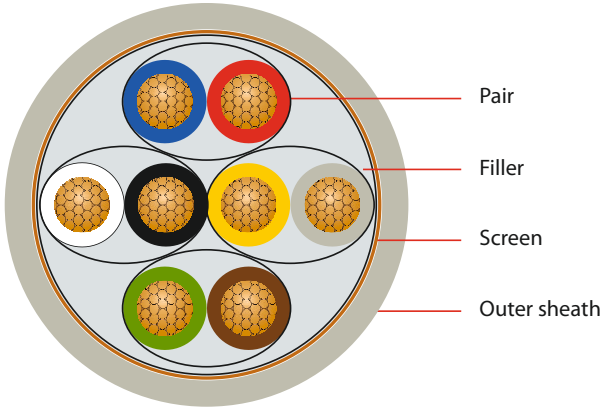

No. of cores and cross section	Sheath thickness approx. mm	Diameter approx. mm	Cable weight approx. kg/km	Copper index kg/km
2 x 2 x 1.0	0.4	8.35	124	57.5
4 x 2 x 1.0	0.4	9.88	168	99.9

APPLICATION

- in heat-appliances and fire resistant installations
- in the lighting and automobile sector
- for sensor applications
- plants in industrial atmosphere
- in the chemical industry

CONSTRUCTION

- Conductor:** tinned copper strand; 32 x 0.2 mm = 1.0 mm²
- Core insulation:** ETFE; wall thickness 0.3 mm; approx. Ø 1.9 mm
- Core identification:** colours acc. VDE 0815 or customer request
- Core stranding:** 2 cores to pair
- Filler:** silicone rubber (round shaping)
- Screen:** tinned copper wire braid; optical coverage approx. 85 %
- Outer sheath:** ETFE; colour: grey (GY) or blue (BU)

ELECTRICAL CHARACTERISTICS

Test voltage	2500 V
Operating capacitance	80 nF/km
Inductance (reference values)	< 1 mH/km

THERMAL & MECHANICAL PROPERTIES

Operating temperature	-90°C to +155°C
-----------------------	-----------------

Subject to changes due to technical progress and error



LI7YC7YS7Y n x 2 x 0.5 GY/BU

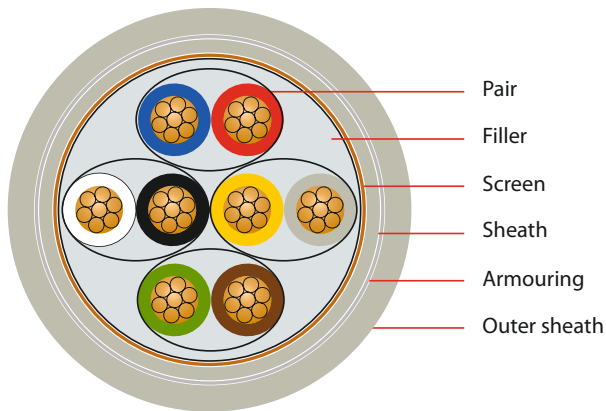

APPLICATION

- in heat-appliances and fire resistant installations
- in the lighting and automobile sector
- for sensor applications
- plants in industrial atmosphere
- in the chemical industry

CONSTRUCTION

- Conductor:** tinned copper strand; $16 \times 0.2 \text{ mm} = 0.5 \text{ mm}^2$
- Core insulation:** ETFE; wall thickness 0.25 mm; approx. $\varnothing 1.45 \text{ mm}$
- Core identification:** colours acc. VDE 0815 or customer request
- Core stranding:** 2 cores to pair
- Filler:** silicone rubber (round shaping)
- Screen:** tinned copper wire braid; optical coverage approx. 85 %
- Sheath:** ETFE
- Armouring:** galvanized steel wire braid ($\varnothing 0.2 \text{ mm}$)
- Outer sheath:** ETFE; colour: grey (GY) or blue (BU)

No. of cores and cross section	Sheath thickness approx. mm	Diameter approx. mm	Cable weight approx. kg/km	Copper index kg/km
2 x 2 x 0.5	0.4	7.88	117	30
4 x 2 x 0.5	0.4	9.3	170	55

ELECTRICAL CHARACTERISTICS

Test voltage	2500 V
Operating capacitance	80 nF/km
Inductance (reference values)	< 1 mH/km

THERMAL & MECHANICAL PROPERTIES

Operating temperature	-90°C to +155°C
-----------------------	-----------------

Subject to changes due to technical progress and error



LI7YC7Y 2 x 1.5 GY / BU / BK

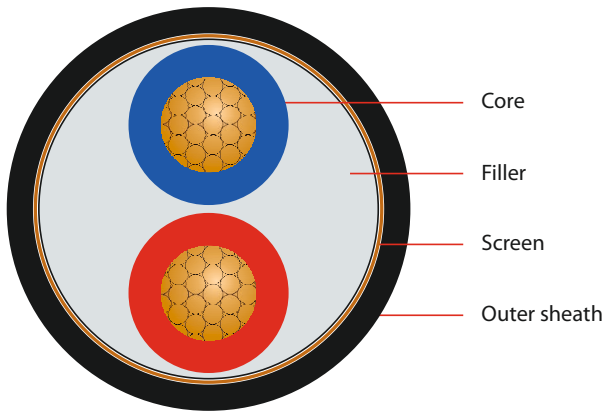

APPLICATION

- in heat-appliances and fire resistant installations
- for sensor applications
- plants in industrial atmosphere
- in the chemical industry

CONSTRUCTION

Conductor: tinned copper strand; $48 \times 0.2 \text{ mm} = 1.5 \text{ mm}^2$

Core insulation: ETFE; wall thickness 0.3 mm; approx. $\varnothing 2.23 \text{ mm}$

Core identification: colours acc. VDE 0815 or customer request

Filler: silicone rubber (round shaping)

Screen: tinned copper wire braid; optical coverage approx. 85 %

Outer sheath: ETFE; colour: grey (GY), blue (BU) or black (BK)

No. of cores and cross section	Sheath thickness approx. mm	Diameter approx. mm	Cable weight approx. kg/km	Copper index kg/km
2 x 1.5	0.4	5.75	53	37

ELECTRICAL CHARACTERISTICS

Operating voltage	600 V
Test voltage	2500 V

THERMAL & MECHANICAL PROPERTIES

Operating temperature	-90°C to +155°C
-----------------------	-----------------

Subject to changes due to technical progress and error



LI6Y 1 x 0.75

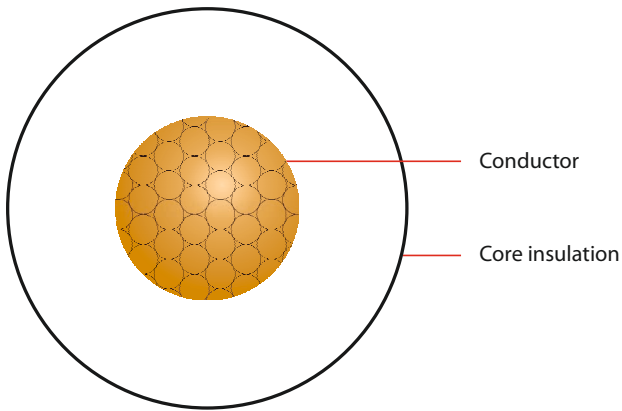

No. of cores and cross section	Sheath thickness approx. mm	Diameter approx. mm	Cable weight approx. kg/km	Copper index kg/km
1 x 0.75	0.35	1.85	11	7.2

APPLICATION

- in heat-appliances and fire resistant installations
- in the lighting and automobile sector
- for sensor applications
- plants in industrial atmosphere
- in the chemical industry

CONSTRUCTION

Conductor: tinned copper strand; 24 x 0.2 mm = 0.75 mm²

Core insulation: FEP

Core identification: white

ELECTRICAL CHARACTERISTICS

Operating voltage	660 V
Test voltage	4000 V

THERMAL & MECHANICAL PROPERTIES

Operating temperature	-90°C to +205°C
-----------------------	-----------------

Subject to changes due to technical progress and error



LI6YC6Y-O/J n x 0.75 GY/BU/BK

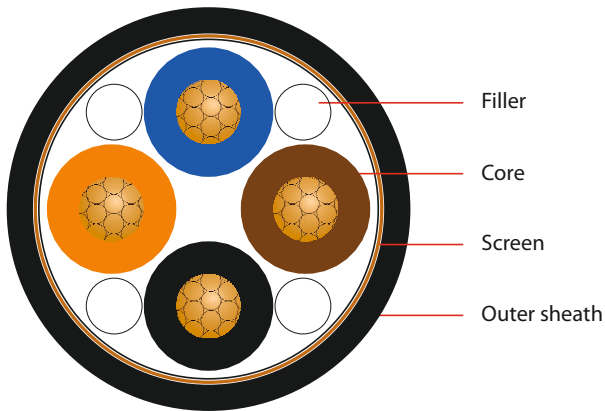

APPLICATION

- in heat-appliances and fire resistant installations
- wiring of controls and computers with high transfer-speed
- plants in industrial atmosphere
- in the chemical industry

CONSTRUCTION

Conductor: tinned copper strand; $24 \times 0.2 \text{ mm} = 0.75 \text{ mm}^2$

Core insulation: FEP;

9 x 0,75: wall thickness 0.25 mm; approx. \varnothing 1.65 mm

Rest: wall thickness 0.30 mm; approx. \varnothing 1.75 mm

Core identification:

4 x 0,75: black, blue, brown, (O) orange or (J) green-yellow

7 x 0,75 (J): black, blue, brown, orange, red, grey, green-yellow

9 x 0,75 (O): black, blue, brown, grey, green, red, yellow, white, violet
or acc. to customer request

Filling: glass fibre

Lapping: polyester tape

Screen: tinned copper wire braid; optical coverage approx. 85 %

Outer sheath: FEP; colour: grey (GY), blue (BU) or black (BK)

No. of cores and cross section	Diameter approx. mm	Cable weight approx. kg/km	Copper index kg/km
4 x 0.75	5.95	78	50
7 x 0.75	7.2	122	74
9 x 0.75	7.4	136	89.2

ELECTRICAL CHARACTERISTICS

Operating voltage	660 V
Test voltage	3000 V

THERMAL & MECHANICAL PROPERTIES

Operating temperature	-90°C to +205°C
-----------------------	-----------------

Subject to changes due to technical progress and error



LI6YC6Y (4+2) x 0.75 GY/BU

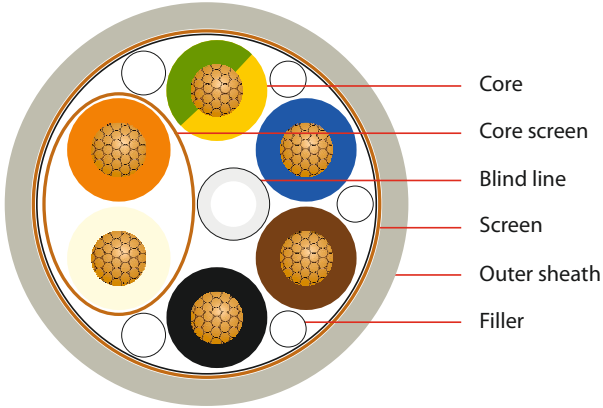

No. of cores and cross section	Sheath thickness approx. mm	Diameter approx. mm	Cable weight approx. kg/km	Copper index kg/km
(4+2) x 0.75	0.6	8.1	130	83

APPLICATION

- in heat-appliances and fire resistant installations
- wiring of controls and computers with high transfer-speed
- plants in industrial atmosphere
- in the chemical industry

CONSTRUCTION

Conductor: tinned copper strand; 24 x 0.2 mm = 0.75 mm²

Core insulation: FEP; wall thickness 0.3 mm; approx. Ø 1.75 mm

Core identification: black, blue, brown, green-yellow; screened: orange and natural colour

Core screen: 2 cores screened with a tinned copper wire braid (Ø 0.1 mm)

Filler: glass fibre; blind line made from silicone

Lapping: polyester tape

Screen: tinned copper wire braid; optical coverage approx. 85 %

Outer sheath: FEP; colour: grey (GY) or blue (BU)

ELECTRICAL CHARACTERISTICS

Operating voltage	660 V
Test voltage	3000 V

THERMAL & MECHANICAL PROPERTIES

Operating temperature	-90°C to +205°C
-----------------------	-----------------

Subject to changes due to technical progress and error



LI6YC6Y-O 24 x 0.75 BK

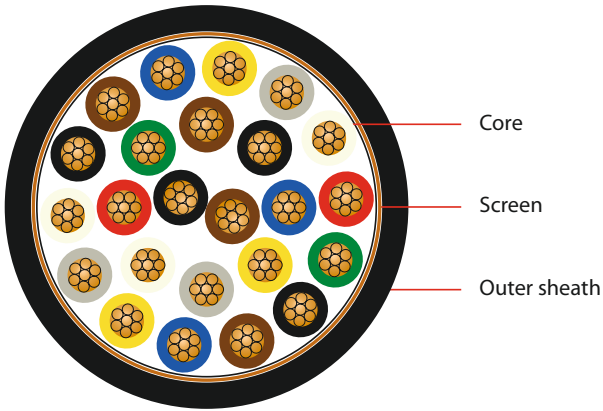

No. of cores and cross section	Diameter approx. mm	Cable weight approx. kg/km	Copper index kg/km
24 x 0.75	11.8	330	218

APPLICATION

- in heat-appliances and fire resistant installations
- wiring of controls and computers with high transfer-speed
- plants in industrial atmosphere
- in the chemical industry

CONSTRUCTION

Conductor: tinned copper strand; 24 x 0.2 mm = 0.75 mm²

Core insulation: FEP; wall thickness 0.25 mm

Core identification:

Stranding 1: black, brown

Stranding 2: black, brown, blue, yellow, grey, natural colour, red, green

Stranding 3: black, brown, blue, yellow, grey, natural colour, red, green
black, brown, blue, yellow, grey, natural colour

Lapping: polyester tape

Screen: tinned copper wire braid; optical coverage approx. 85 %

Outer sheath: FEP; colour: black (BK)

ELECTRICAL CHARACTERISTICS

Operating voltage 300 V

Test voltage 2000 V

THERMAL & MECHANICAL PROPERTIES

Operating temperature -90°C to +205°C

Subject to changes due to technical progress and error



LI6YC6Y-O/J 32 x 0.75 BK

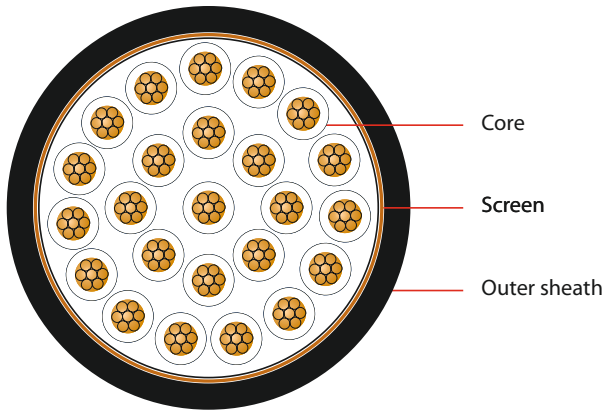

No. of cores and cross section	Diameter approx. mm	Cable weight approx. kg/km	Copper index kg/km
32 x 0.75	14.0	450	282.2

APPLICATION

- in heat-appliances and fire resistant installations
- wiring of controls and computers with high transfer-speed
- plants in industrial atmosphere
- in the chemical industry

CONSTRUCTION

Conductor: tinned copper strand; 24 x 0.2 mm = 0.75 mm²; semiconcentric

Core insulation: FEP; approx. Ø 1.65 mm; units in 3 layers

Core identification: unicoloured with bar code, (J) one core green-yellow

Lapping: polyester tape

Screen: tinned copper wire braid; optical coverage approx. 85 %

Outer sheath: FEP; colour: black (BK)

ELECTRICAL CHARACTERISTICS

Operating voltage	600 V
Test voltage	2500 V

THERMAL & MECHANICAL PROPERTIES

Operating temperature	-90°C to +205°C
-----------------------	-----------------

Subject to changes due to technical progress and error



LI6YC6Y-O/J n x 1.5 GY/BU/BK

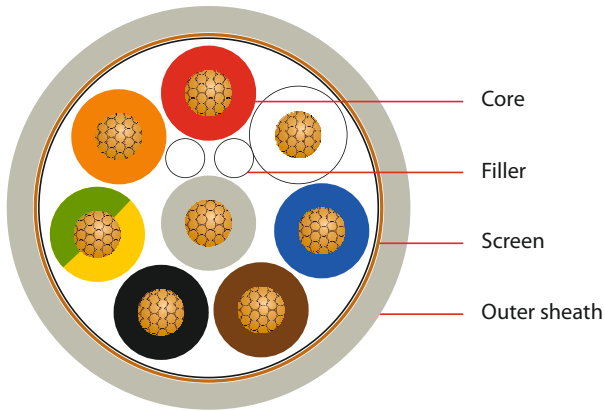

No. of cores and cross section	Sheath thickness approx. mm	Diameter approx. mm	Cable weight approx. kg/km	Copper index kg/km
4 x 1.5	0.5	7.2	116	79.8
8 x 1.5	0.6	9.3	219	148

APPLICATION

- in heat-appliances and fire resistant installations
- wiring of controls and computers with high transfer-speed
- plants in industrial atmosphere
- in the chemical industry

CONSTRUCTION

Conductor: tinned copper strand; 48 x 0.2 mm = 1.5 mm²

Core insulation: FEP; wall thickness 0.35 mm; approx. Ø 2.3 mm

Core identification:

4 x 1,5: black, blue, brown, (O) orange or (J) green-yellow

8 x 1,5 (J): black, blue, brown, orange, red, grey, white, green-yellow or acc. to customer request

Filler: glass fibre

Lapping: polyester tape

Screen: tinned copper wire braid; optical coverage approx. 85 %

Outer sheath: FEP; colour: grey (GY), blue (BU) or black (BK)

ELECTRICAL CHARACTERISTICS

Operating voltage	660 V
Test voltage	3000 V

THERMAL & MECHANICAL PROPERTIES

Operating temperature	-90°C to +205°C
-----------------------	-----------------

Subject to changes due to technical progress and error



LI6YC6Y-O/J 3 x 2.5 BK

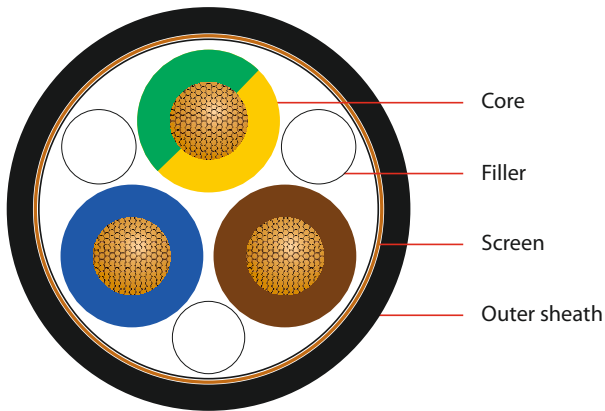

APPLICATION

- in heat-appliances and fire resistant installations
- wiring of controls and computers with high transfer-speed
- plants in industrial atmosphere
- in the chemical industry

CONSTRUCTION

Conductor: tinned copper strand; $50 \times 0.25 \text{ mm} = 2.5 \text{ mm}^2$

Core insulation: FEP; wall thickness 0.3 mm; approx. \varnothing 2.67 mm

Core identification:

blue, brown, (O) orange or (J) green-yellow or acc. to customer request

Filler: glass fibre

Lapping: polyester tape

Screen: tinned copper wire braid; optical coverage approx. 85 %

Outer sheath: FEP; colour: black (BK)

No. of cores and cross section	Sheath thickness approx. mm	Diameter approx. mm	Cable weight approx. kg/km	Copper index kg/km
3 x 2.5	0.5	7.1	140	102

ELECTRICAL CHARACTERISTICS

Operating voltage	660 V
Test voltage	3000 V

THERMAL & MECHANICAL PROPERTIES

Operating temperature	-90°C to +205°C
-----------------------	-----------------

Subject to changes due to technical progress and error



T.K. Kabel oHG · Geschwister-Scholl-Straße 11 · 71384 Weinstadt

Phone +49 (0) 7151/60 68 70 · Fax +49 (0) 7151/60 91 00 · info@tk-kabel.de · www.tk-kabel.de

LI6YC6Y-O/J 4 x AWG 14 BK

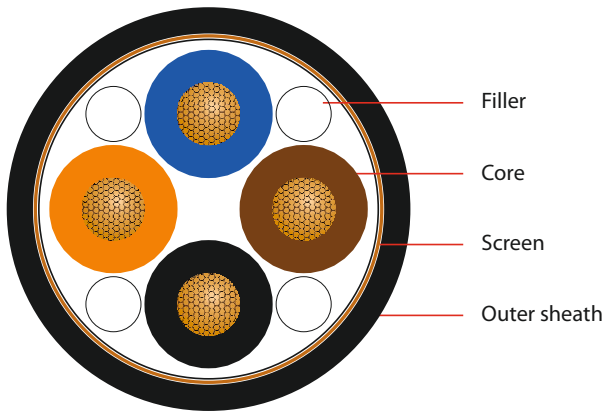

No. of cores and cross section	Diameter approx. mm	Cable weight approx. kg/km	Copper index kg/km
4 x AWG 14	8.3	162	107.4

APPLICATION

- in heat-appliances and fire resistant installations
- wiring of controls and computers with high transfer-speed
- plants in industrial atmosphere
- in the chemical industry

CONSTRUCTION

Conductor: tinned copper strand; 19 x 0.36 mm = AWG 14

Core insulation: FEP

Core identification:

black, brown, blue, (O) orange or (J) green-yellow
or acc. to customer request

Filler: glass fibre

Lapping: polyester tape

Screen: tinned copper wire braid; optical coverage approx. 85 %

Outer sheath: FEP; colour: black

ELECTRICAL CHARACTERISTICS

Operating voltage	900 V
Test voltage	2500 V

THERMAL & MECHANICAL PROPERTIES

Operating temperature	-90°C to +205°C
-----------------------	-----------------

Subject to changes due to technical progress and error



LI6YC6YS-O/J 3 x 2.5

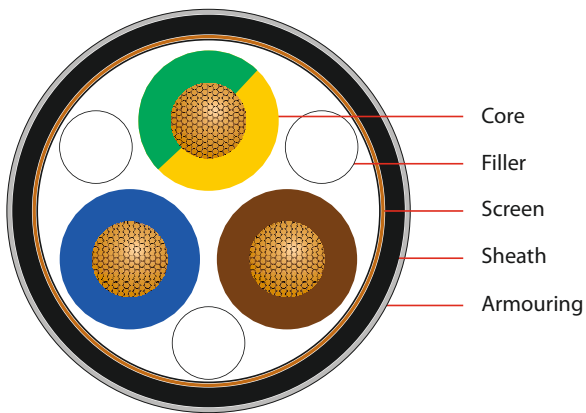

No. of cores and cross section	Diameter approx. mm	Cable weight approx. kg/km	Copper index kg/km
3 x 2.5	8.4	180	101

APPLICATION

- in heat-appliances and fire resistant installations
- wiring of controls and computers with high transfer-speed
- plants in industrial atmosphere
- in the chemical industry

CONSTRUCTION

Conductor: tinned copper strand; 50 x 0.25 mm = 2.5 mm²

Core insulation: FEP; wall thickness 0.3 mm; approx. Ø 2.7 mm

Core identification:

blue, brown, (O) orange or (J) green-yellow

or acc. to customer request

Filler: glass fibre

Lapping: polyester tape

Screen: tinned copper wire braid; optical coverage approx. 85 %

Sheath: FEP; wall thickness 0.5 mm

Armouring: galvanized steel wire braid (Ø 0.2 mm)

ELECTRICAL CHARACTERISTICS

Operating voltage 660 V

Test voltage 3000 V

THERMAL & MECHANICAL PROPERTIES

Operating temperature -90°C to +205°C

Subject to changes due to technical progress and error

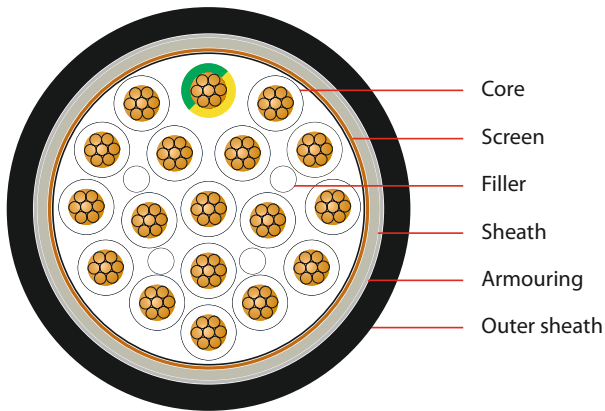

LI6YC6YS6Y-J 18 x 0.5 BK

No. of cores and cross section	Sheath thickness approx. mm	Diameter approx. mm	Cable weight approx. kg/km	Copper index kg/km
18 x 0.5	0.8	11.75	300	121

APPLICATION

- in heat-appliances and fire resistant installations
- wiring of controls and computers with high transfer-speed
- plants in industrial atmosphere
- in the chemical industry

CONSTRUCTION

Conductor: tinned copper strand; $16 \times 0.2 \text{ mm} = 0.5 \text{ mm}^2$

Core insulation: FEP; wall thickness 0.25 mm; approx. \varnothing 1.45 mm

Core identification: white with black bar code, one core green-yellow

Filler: glass fibre

Lapping: polyester tape

Screen: tinned copper wire braid; optical coverage approx. 85 %

Sheath: FEP

Armouring: galvanized steel wire braid (\varnothing 0.2 mm)

Outer sheath: FEP; colour: black (BK)

ELECTRICAL CHARACTERISTICS

Operating voltage	300 V
Test voltage	2000 V

THERMAL & MECHANICAL PROPERTIES

Operating temperature	-90°C to +205°C
-----------------------	-----------------

Subject to changes due to technical progress and error



LI6YC6YS6Y-O/J n x 0.75 BK

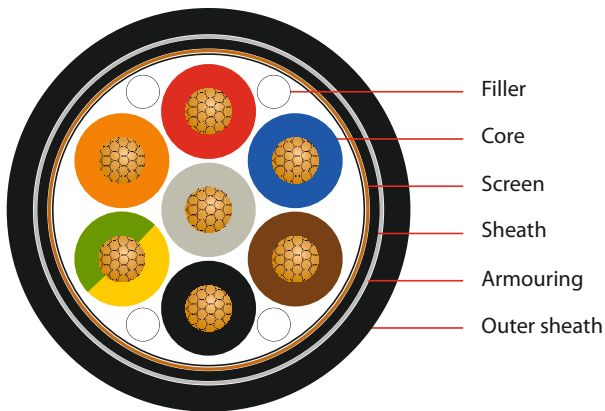

APPLICATION

- in heat-appliances and fire resistant installations
- wiring of controls and computers with high transfer-speed
- plants in industrial atmosphere
- in the chemical industry

CONSTRUCTION

Conductor: tinned copper strand; $24 \times 0.2 \text{ mm} = 0.75 \text{ mm}^2$

Core insulation: FEP;

n x 0.75: wall thickness 0.30 mm; approx. \varnothing 1.75 mm

12 x 0.75 & 24 x 0.75: wall thickness 0.25 mm; approx. \varnothing 1.65 mm

Core identification:

4 x 0.75: black, blue, brown, (O) orange or (J) green-yellow

7 x 0.75: black, blue, brown, orange, red, grey, (J) green-yellow

12 x 0.75 & 24 x 0.75: white (numbered with bar cod)

or acc. to customer request

Filler: glass fibre

Lapping: polyester tape

Screen: tinned copper wire braid; optical coverage approx. 85 %

Sheath: FEP

Armouring: galvanized steel wire braid (\varnothing 0.2 mm)

Outer sheath: FEP; colour: black (BK)

no. of cores and cross section	Diameter approx. mm	Cable weight approx. kg/km	Copper index kg/km
4 x 0.75	7.7	152	50
7 x 0.75	9.5	175	74
12 x 0.75	10.65	269	118.4
24 x 0.75	14.5	510	218

ELECTRICAL CHARACTERISTICS

Operating voltage	300 V
Test voltage	2000 V

THERMAL & MECHANICAL PROPERTIES

Operating temperature	-90°C to +205°C
-----------------------	-----------------

Subject to changes due to technical progress and error



T.K. Kabel oHG · Geschwister-Scholl-Straße 11 · 71384 Weinstadt

Phone +49 (0) 7151/60 68 70 · Fax +49 (0) 7151/60 91 00 · info@tk-kabel.de · www.tk-kabel.de

LI6YC6YS6Y-O/J n x 1.5 BK

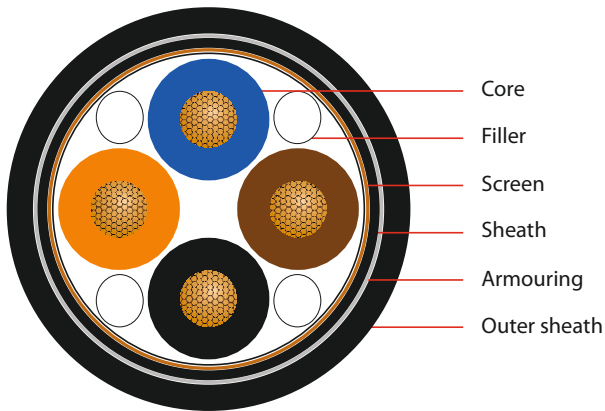

No. of cores and cross section	Sheath thickness approx. mm	Diameter approx. mm	Cable weight approx. kg/km	Copper index kg/km
4 x 1.5	0.5	9.05	214	80
5 x 1.5	0.7	10.5	256	104
8 x 1.5	0.7	11.8	335	148

APPLICATION

- in heat-appliances and fire resistant installations
- wiring of controls and computers with high transfer-speed
- plants in industrial atmosphere
- in the chemical industry

CONSTRUCTION

Conductor: tinned copper strand; $48 \times 0.2 \text{ mm} = 1.5 \text{ mm}^2$

Core insulation: FEP; wall thickness 0.35 mm; approx. \varnothing 2.30 mm

Core identification:

4 x 1.5: black, blue, brown, (O) orange or (J) green-yellow

5 x 1.5: black, blue, brown, red, (O) orange or (J) green-yellow

8 x 1.5: black, blue, brown, orange, red, grey, white and green-yellow
or acc. to customer request

Filler: glass fibre

Lapping: polyester tape

Screen: tinned copper wire braid; optical coverage approx. 85 %

Sheath: FEP

Armouring: galvanized steel wire braid (\varnothing 0.2 mm)

Outer sheath: FEP; colour: black (BK)

ELECTRICAL CHARACTERISTICS

Operating voltage 660 V

Test voltage 3000 V

THERMAL & MECHANICAL PROPERTIES

Operating temperature -90°C to $+205^\circ\text{C}$

Subject to changes due to technical progress and error



T.K. Kabel oHG · Geschwister-Scholl-Straße 11 · 71384 Weinstadt

Phone +49 (0) 7151/60 68 70 · Fax +49 (0) 7151/60 91 00 · info@tk-kabel.de · www.tk-kabel.de

LISOSI 0.75

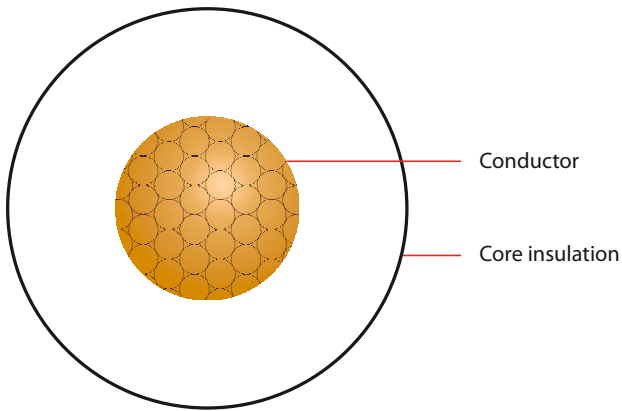

No. of cores and cross section	Sheath thickness approx. mm	Diameter approx. mm	Cable weight approx. kg/km	Copper index kg/km
1 x 0.75	0.6	2.35	11	7.2

APPLICATION

Flame retardant and halogen-free connecting cable

CONSTRUCTION

Conductor: tinned copper strand; 24 x 0.2 mm = 0.75 mm²

Core insulation: silicone rubber FRNC

ELECTRICAL CHARACTERISTICS

Operating voltage	300 V
Test voltage	2500 V

THERMAL & MECHANICAL PROPERTIES

Operating temperature	-50°C to +180°C
-----------------------	-----------------

Subject to changes due to technical progress and error

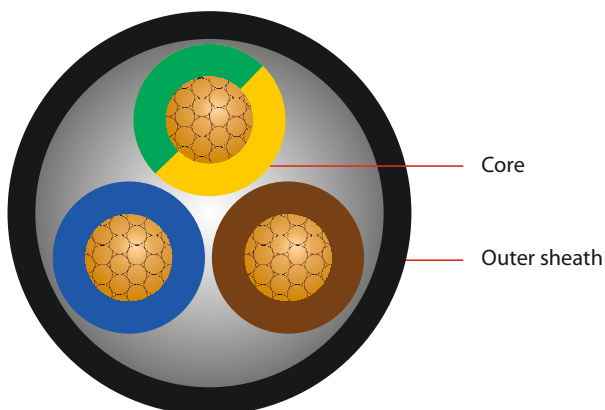

LISOSISOSI-O/J n x 1.5 BK**APPLICATION**

Movable copper conductor for small mechanical loading in dry and wet rooms as well as outdoors

CONSTRUCTION

Conductor: tinned copper strand; $48 \times 0.2 \text{ mm} = 1.5 \text{ mm}^2$

Core insulation: notch-tight silicone rubber (2G) FRNC; wall thickness 0.8 mm;

2 x 1,5: approx. \varnothing 3.00 mm

3 x 1,5: approx. \varnothing 3.23 mm

Core identification: acc. to VDE 0293 or customer request

Outer sheath: notch-tight silicone rubber (2G) FRNC; colour: black (BK)

No. of cores and cross section	Diameter approx. mm	Cable weight approx. kg/km	Copper index kg/km
2 x 1.5	8.1	88	28.8
3 x 1.5	10.0	139	43

ELECTRICAL CHARACTERISTICS

Operating voltage 300/500 V

Test voltage 2500 V

THERMAL & MECHANICAL PROPERTIES

Operating temperature -25°C to +180°C

Subject to changes due to technical progress and error



T.K. Kabel oHG · Geschwister-Scholl-Straße 11 · 71384 Weinstadt

Phone +49 (0) 7151/60 68 70 · Fax +49 (0) 7151/60 91 00 · info@tk-kabel.de · www.tk-kabel.de

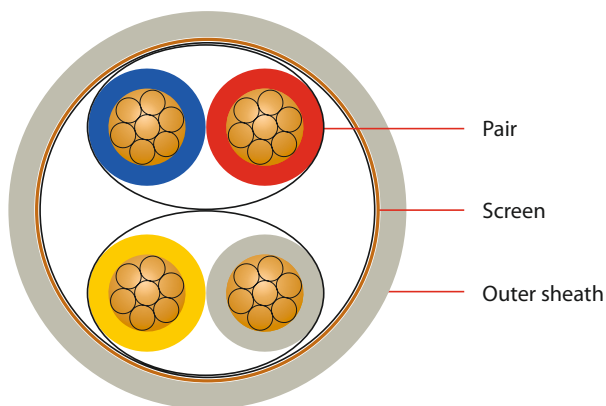
LISOSICSOSI n x 2 x 0.5 GY/BU**APPLICATION**

Movable copper conductor for small mechanical loading in dry-, moist- and wet-rooms as well as outdoors

CONSTRUCTION

Conductor: tinned copper strand; $16 \times 0.2 \text{ mm} = 0.5 \text{ mm}^2$

Core insulation: notch-tight silicone rubber (2G) FRNC; approx. $\varnothing 1.95 \text{ mm}$

Core identification: acc. to VDE 0293 or customer request

Core stranding: 2 cores to pair

Lapping: polyester tape

Screen: tinned copper wire braid; optical coverage approx. 85 %

Outer sheath: notch-tight silicone rubber (2G) FRNC; colour: grey or blue

No. of cores and cross section	Diameter approx. mm	Cable weight approx. kg/km	Copper index kg/km
2 x 2 x 0.5	10.6	81	50.4
4 x 2 x 0.5	11.9	148	70

ELECTRICAL CHARACTERISTICS

Operating voltage 300/500 V

Test voltage 2500 V

THERMAL & MECHANICAL PROPERTIES

Operating temperature -25°C to $+180^{\circ}\text{C}$

Subject to changes due to technical progress and error



T.K. Kabel oHG · Geschwister-Scholl-Straße 11 · 71384 Weinstadt

Phone +49 (0) 7151/60 68 70 · Fax +49 (0) 7151/60 91 00 · info@tk-kabel.de · www.tk-kabel.de

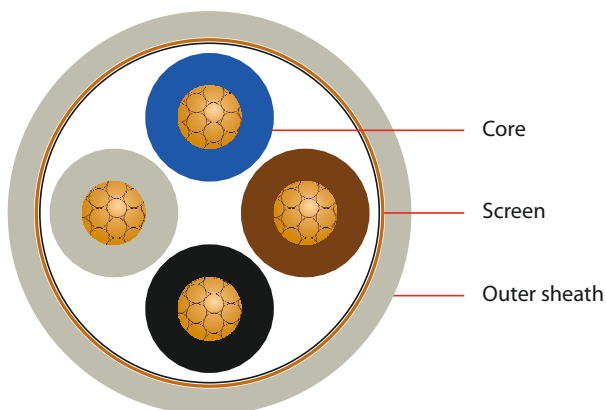
LISOSICSOSI-O/J n x 0.75 GY/BU**APPLICATION**

Flexible copper conductor for small mechanical stress

CONSTRUCTION

Conductor: tinned copper strand; $24 \times 0.2 \text{ mm} = 0.75 \text{ mm}^2$

Core insulation: silicone rubber (FRNC); wall thickness 0.6 mm

Core identification: acc. to VDE 0293 or customer request

Lapping: polyester tape

Screen: tinned copper wire braid; optical coverage approx. 85 %

Outer sheath: notch-tight silicone rubber (2G) FRNC;
colour: grey (GY) or blue (BU)

No. of cores and cross section	Diameter approx. mm	Cable weight approx. kg/km	Copper index kg/km
4 x 0.75	8.4	101	54.8
7 x 0.75	9.9	148	82.6

ELECTRICAL CHARACTERISTICS

Operating voltage 300/500 V

Test voltage 2500 V

THERMAL & MECHANICAL PROPERTIES

Operating temperature -25°C to +180°C

Subject to changes due to technical progress and error

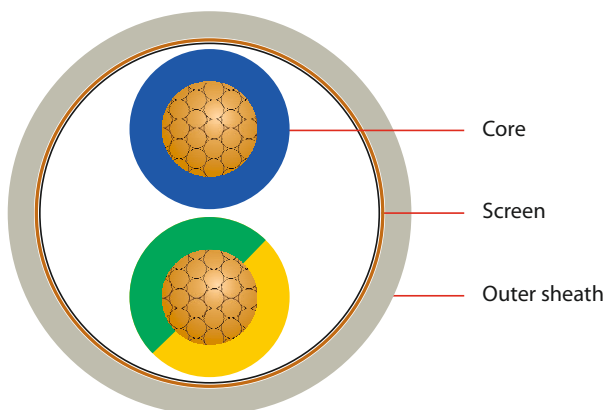

LISOSICSOSI-O/J n x 1.5 GY/BU

**APPLICATION**

Movable copper conductor for small mechanical loading in dry-, moist- and wet-rooms as well as outdoors

CONSTRUCTION

Conductor: tinned copper strand; $48 \times 0.2 \text{ mm} = 1.5 \text{ mm}^2$

Core insulation: notch-tight silicone rubber (2G) FRNC; wall thickness 0.7 mm; approx. \varnothing 3.00 mm

Core identification: acc. to VDE 0293 or customer request

Lapping: polyester tape

Screen: tinned copper wire braid; optical coverage approx. 85 %

Outer sheath: notch-tight silicone rubber (2G) FRNC; colour: grey (GY) or blue (BU)

No. of cores and cross section	Diameter approx. mm	Cable weight approx. kg/km	Copper index kg/km
2 x 1.5	9.1	104	54.9
4 x 1.5	10.0	152	90.6

ELECTRICAL CHARACTERISTICS

Operating voltage 300/500 V

Test voltage 2500 V

THERMAL & MECHANICAL PROPERTIES

Operating temperature -25°C to +180°C

Subject to changes due to technical progress and error



T.K. Kabel oHG · Geschwister-Scholl-Straße 11 · 71384 Weinstadt

Phone +49 (0) 7151/60 68 70 · Fax +49 (0) 7151/60 91 00 · info@tk-kabel.de · www.tk-kabel.de

LISOSICSOSI 4 x 1.5 + 3 x 0.38

(Silicone control cable)

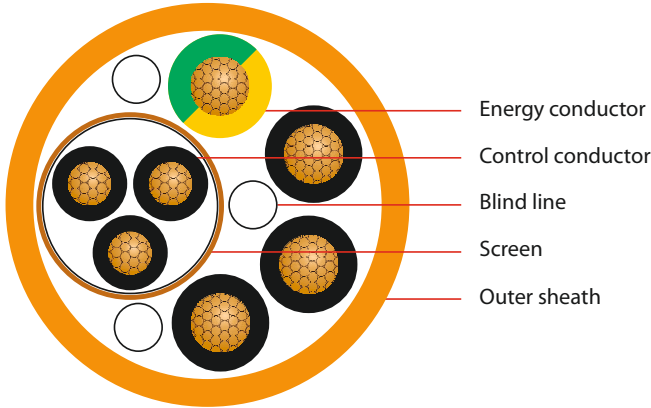

No. of cores and cross section	Diameter approx. mm	Cable weight approx. kg/km	Copper index kg/km
4 x 1.5 + 3 x 0.38	13.5	255	90

CONSTRUCTION

Control conductor: tinned copper strand; 12 x 0.2 mm = 0.38 mm²

Core insulation: silicone rubber FRNC

Core identification: black with white numbers

Lapping: polyester tape

Screen: nickel plated copper wire braid (Ø 0.16 mm)

Energy conductor: nickel plated copper strand; 48 x 0.2 mm = 1.5 mm²; blind lines made from glass fibre fillers

Core insulation: silicone rubber FRNC

Core identification: 3 cores black with white numbers, 1 core green-yellow

Outer sheath: silicone rubber FRNC; colour: orange

THERMAL & MECHANICAL PROPERTIES

Operating temperature -25°C to +180°C

Subject to changes due to technical progress and error

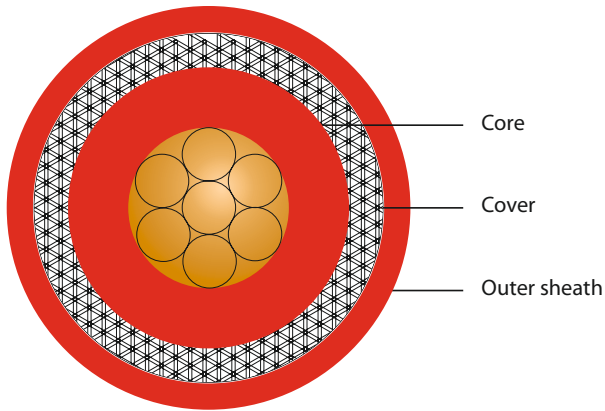

LISOSI51Y 1 x 1.5

**APPLICATION**

Ignition lead

CONSTRUCTION**Conductor:** tinned copper strand; $48 \times 0.2 \text{ mm} = 1.5 \text{ mm}^2$ **Core insulation:** notch-tight silicone rubber (2G) FRNC;
approx. \varnothing 5.40 mm**Cover:** glass fibre braid**Outer sheath:** PFA (51Y); colour: red

No. of cores and cross section	Sheath thickness approx. mm	Diameter approx. mm	Cable weight approx. kg/km	Copper index kg/km
1 x 1.5	0.5	7.0	69	14.4

ELECTRICAL CHARACTERISTICS

Ignition voltage at 50Hz

8 kV eff

Test voltage at 50Hz

15 kV eff

THERMAL & MECHANICAL PROPERTIES

Operating temperature

-50°C to +180°C

Subject to changes due to technical progress and error



T.K. Kabel oHG · Geschwister-Scholl-Straße 11 · 71384 Weinstadt

Phone +49 (0) 7151/60 68 70 · Fax +49 (0) 7151/60 91 00 · info@tk-kabel.de · www.tk-kabel.de



T.K. Kabel oHG



T.K. Kabel oHG · Geschwister-Scholl-Straße 11 · 71384 Weinstadt

Phone +49 (0) 7151/60 68 70 · Fax +49 (0) 7151/60 91 00 · info@tk-kabel.de · www.tk-kabel.de



T.K. Kabel oHG

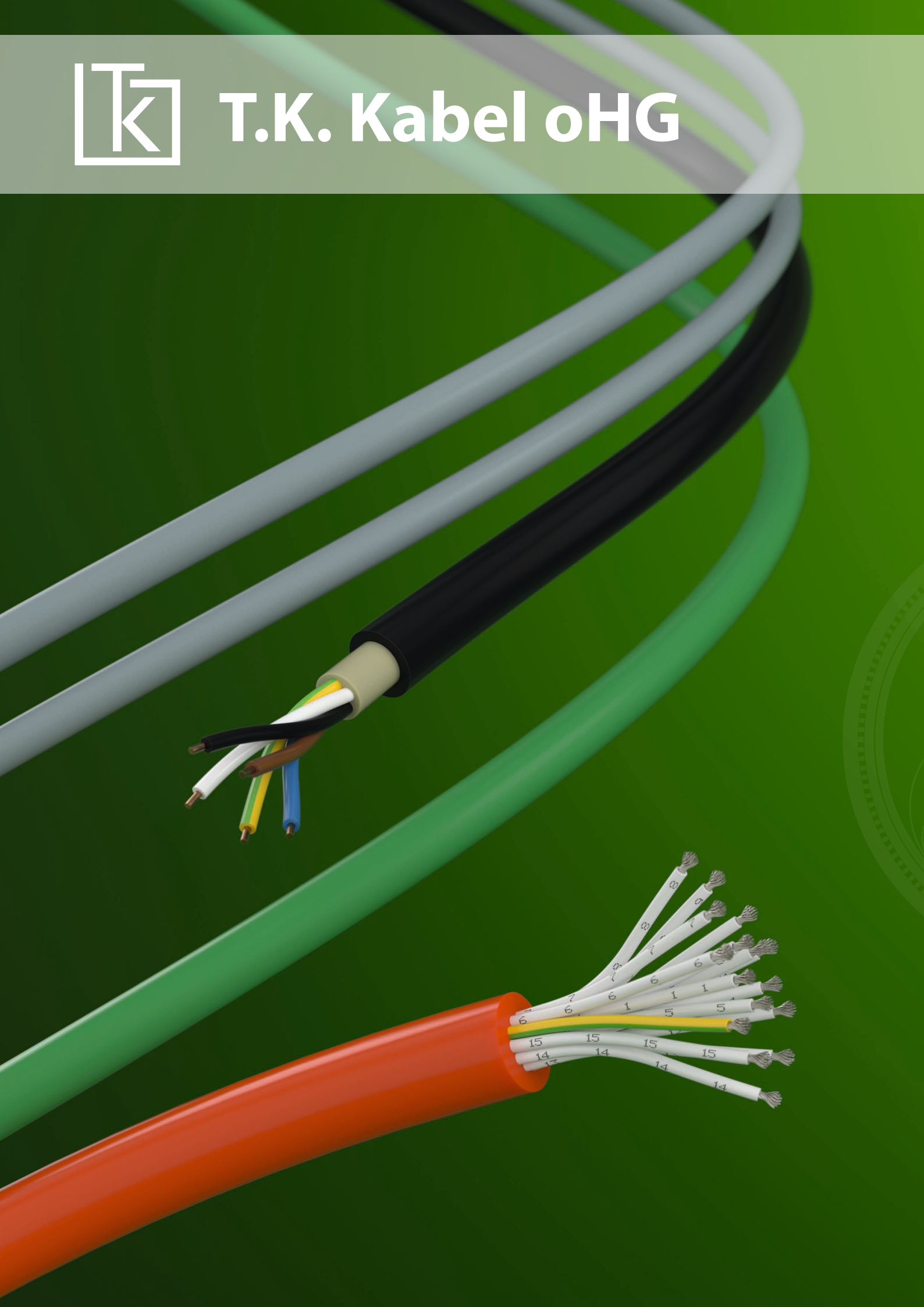

Compensating cables

AGL LI7YC7Y NC IEC 1 x 2 x 0.75	112
AGL LI7YC7Y KCA IEC n x 2 x 0.75	113
AGL LI7YC7Y KCA IEC 2 x 2 x 0.75 nr	114
AGL LI7YC7Y KCA IEC n x 2 x 1.0	115
AGL LI7YC7YS7Y KCA IEC n x 2 x 0.75	116
<hr/>	
AGL LI6YC6Y KCA DIN n x 0.75	117
<hr/>	
AGL LISI(St)SI KCA IEC 2 x 1.5	118
AGL LISOSICSOSI KCA (IEC,DIN) n x 0.75	119
AGL LISOSICSOSI KCA IEC n x 2 x 0.75	120

AGL LI7YC7Y NC IEC n x 2 x 0.75

acc. to DIN IEC 60584

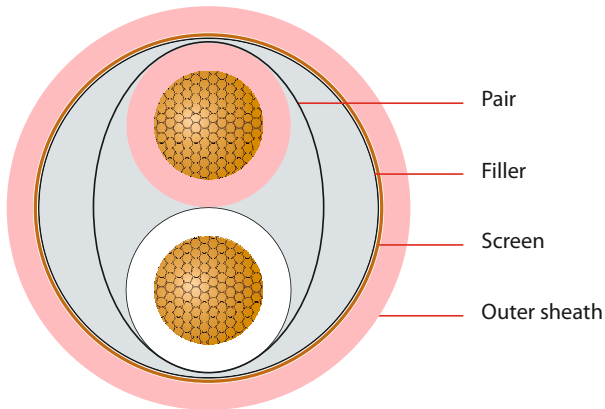

CONSTRUCTION

Conductor: compensation alloy for NiCroSil-NiSiI, NC IEC;
 $24 \times 0.2 \text{ mm} = 0.75 \text{ mm}^2$

Core insulation: ETFE; wall thickness 0.25 mm; approx. \varnothing 1.65 mm

Core identification: pink (+) and white (-)

from 2 x 2 x 0.75: additional pairs with bar code

Filler: silicone rubber (round shaping), from 4 x 2 x 0.75 glass fibre

Lapping: polyester tape

Screen: tinned copper wire braid;
 optical coverage approx. 85 %

Outer sheath: ETFE; colour: pinkz

No. of cores and cross section	Sheath thickness approx. mm	Diameter approx. mm	Cable weight approx. kg/km	Copper index kg/km
1 x 2 x 0.75	0.4	4.8	43	14.0
2 x 2 x 0.75	0.4	7.3	87	21.8
3 x 2 x 0.75	0.4	7.7	128	24.3
4 x 2 x 0.75	0.5	8.7	137	33.8
7 x 2 x 0.75	0.5	10.15	236	40.1
8 x 2 x 0.75	0.5	11.2	255	41
12 x 2 x 0.75	0.6	13.2	360	48

ELECTRICAL CHARACTERISTICS

Test voltage 500 V

THERMAL & MECHANICAL PROPERTIES

Operating temperature -90°C to +155°C

Subject to changes due to technical progress and error



T.K. Kabel oHG · Geschwister-Scholl-Straße 11 · 71384 Weinstadt
 Phone +49 (0) 7151/60 68 70 · Fax +49 (0) 7151/60 91 00 · info@tk-kabel.de · www.tk-kabel.de

AGL LI7YC7Y KCA IEC n x 2 x 0.75 Eca/Fca

acc. to DIN IEC 60584

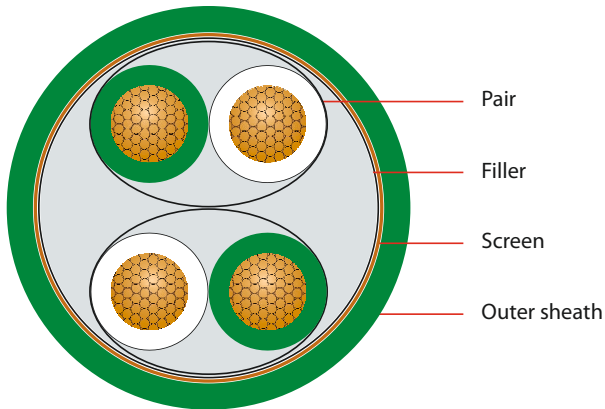

APPLICATION

Compensation cable KCA for temperature sensors

CONSTRUCTION

Conductor: compensation alloy for NiCr-Ni, KCA IEC (Fe-CuNi);
24 x 0.2 mm = 0.75 mm²

Core insulation: ETFE; wall thickness 0.25 mm; approx. Ø 1.65 mm

Core identification: green (+) and white (-)

from 2 x 2 x 0.75: additional pairs with bar code

Filler: silicone rubber (round shaping), from 4 x 2 x 0.75 glass fibre

Lapping: polyester tape

Screen: tinned copper wire braid;
optical coverage approx. 85 %

Outer sheath: ETFE; colour: green

No. of cores and cross section	Sheath thickness approx. mm	Diameter approx. mm	Cable weight approx. kg/km	Copper index kg/km
1 x 2 x 0.75	0.4	4.8	43	14.0
2 x 2 x 0.75	0.4	7.3	87	21.8
3 x 2 x 0.75	0.4	7.7	128	36.0
4 x 2 x 0.75	0.5	9.3	137	33.8
7 x 2 x 0.75	0.5	10.15	236	40.1
8 x 2 x 0.75	0.5	12.4	255	48.0
12 x 2 x 0.75	0.6	13.2	360	54.0

ELECTRICAL CHARACTERISTICS

Test voltage 500 V

THERMAL & MECHANICAL PROPERTIES

Operating temperature -90°C to +155°C

Subject to changes due to technical progress and error



AGL LI7YC7Y KCA IEC 2 x 2 x 0.75 nr

acc. to DIN IEC 60584

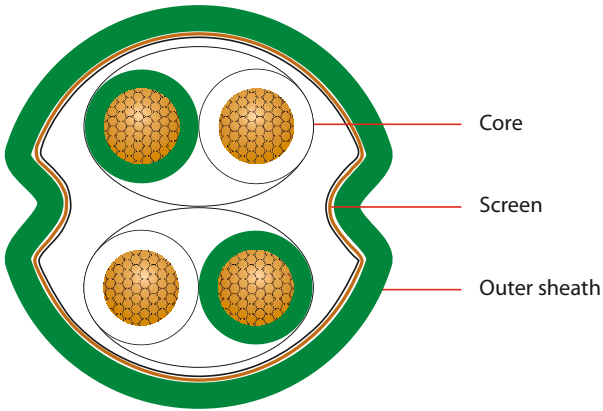

No. of cores and cross section	Sheath thickness approx. mm	Diameter approx. mm	Cable weight approx. kg/km	Copper index kg/km
2 x 2 x 0.75	0.45	7.0	64	18.8

APPLICATION

Compensation cable KCA for temperature sensors

CONSTRUCTION

Conductor: compensation alloy for NiCr-Ni, KCA IEC (Fe-CuNi);
24 x 0.2 mm = 0.75 mm²

Core insulation: ETFE; wall thickness 0.25 mm; approx. Ø 1.6 mm

Core identification: green (+) and white (-); bar code on 1 pair

Lapping: polyester tape

Screen: tinned copper wire braid; optical coverage approx. 85 %

Outer sheath: ETFE; colour: green

ELECTRICAL CHARACTERISTICS

Test voltage 500 V

THERMAL & MECHANICAL PROPERTIES

Operating temperature -90°C to +155°C

Subject to changes due to technical progress and error



AGL LI7YC7Y KCA IEC n x 2 x 1.0

acc. to DIN IEC 60584

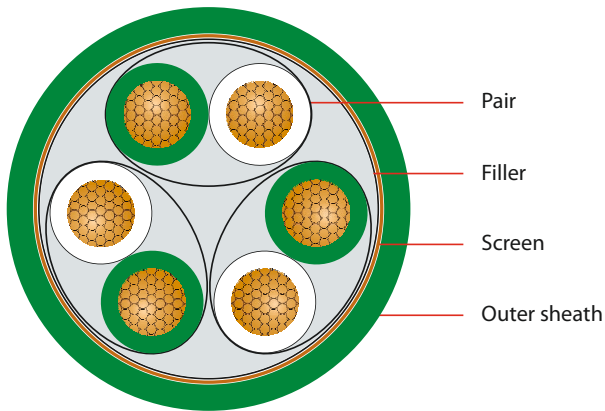

APPLICATION

Compensation cable KCA for temperature sensors

CONSTRUCTION

Conductor: compensation alloy for NiCr-Ni; KCA IEC (Fe-CuNi);
 $32 \times 0.2 \text{ mm} = 1.0 \text{ mm}^2$

Core insulation: ETFE; wall thickness 0.25 mm; approx. \varnothing 1.77 mm

Core identification: green (+) and white (-),
 from 2 x 2 x 1.0: additional pairs with bar code

Filler: silicone rubber (round shaping)

Lapping: polyester tape

Screen: tinned copper wire braid;
 optical coverage approx. 85 %

Outer sheath: ETFE; colour: green

No. of cores and cross section	Sheath thickness approx. mm	Diameter approx. mm	Cable weight approx. kg/km	Copper index kg/km
1 x 2 x 1.0	0.4	5.5	53.3	15.8
2 x 2 x 1.0	0.4	7.7	112	23.7
3 x 2 x 1.0	0.4	8.2	133	27.1

ELECTRICAL CHARACTERISTICS

Test voltage 500 V

THERMAL & MECHANICAL PROPERTIES

Operating temperature -90°C to +155°C

Subject to changes due to technical progress and error



AGL LI7YC7YS7Y KCA IEC

n x 2 x 0.75

acc. to DIN IEC 60584

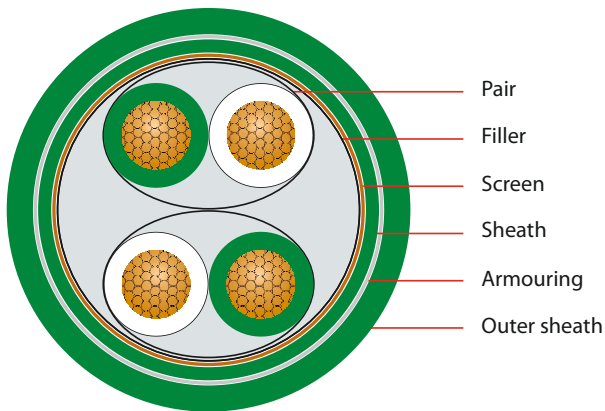

No. of cores and cross section	Sheath thickness approx. mm	Diameter approx. mm	Cable weight approx. kg/km	Copper index kg/km
1 x 2 x 0.75	0.4	6.35	83	14.0
2 x 2 x 0.75	0.5	9.1	161	21.8
3 x 2 x 0.75	0.7	10.0	197	24.3
4 x 2 x 0.75	0.8	10.1	243	36.0
8 x 2 x 0.75	1.2	14.0	346	41.0

APPLICATION

Compensation cable KCA for temperature sensors

CONSTRUCTION

Conductor: compensation alloy for NiCr-Ni, KCA IEC (Fe-CuNi);
 $24 \times 0.2 \text{ mm} = 0.75 \text{ mm}^2$

Core insulation: ETFE; wall thickness 0.25 mm; approx. \varnothing 1.65 mm

Core identification: green (+) and white (-),
 from 1 x 2 x 0.75: additional pairs with bar code

Filler: silicone rubber (round shaping), from 4 x 2 x 0.75 glass fibre

Lapping: polyester tape

Screen: tinned copper wire braid;
 optical coverage approx. 85 %

Sheath: ETFE

Armouring: galvanized steel wire braid (\varnothing 0.2 mm)

Outer sheath: ETFE; colour: green

ELECTRICAL CHARACTERISTICS

Test voltage 500 V

THERMAL & MECHANICAL PROPERTIES

Operating temperature -90°C to +155°C

Subject to changes due to technical progress and error



AGL LI6YC6Y KCA DIN n x 0.75

acc. to DIN 43714

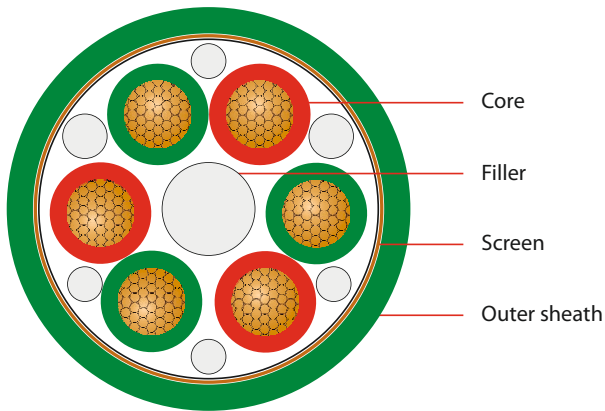

APPLICATION

Compensation cable KCA for temperature sensors

CONSTRUCTION

Conductor: compensation alloy for NiCr-Ni, KCA DIN (Fe-CuNi);
 $24 \times 0.2 \text{ mm} = 0.75 \text{ mm}^2$

Core insulation: FEP; wall thickness 0.25 mm; approx. \varnothing 1.65 mm

Core identification: red (+) and green (-); from 4 x 0.75: numbered

Filler: glass fibre

Lapping: polyester tape

Screen: tinned copper wire braid;
 optical coverage approx. 85 %

Outer sheath: FEP; colour: green

No. of cores and cross section	Sheath thickness approx. mm	Diameter approx. mm	Cable weight approx. kg/km	Copper index kg/km
2 x 0.75	0.4	5.2	48	21.8
4 x 0.75	0.4	5.9	78	24.0
6 x 0.75	0.4	7.2	110	27.2

ELECTRICAL CHARACTERISTICS

Test voltage 500 V

THERMAL & MECHANICAL PROPERTIES

Operating temperature -90°C to +205°C

Subject to changes due to technical progress and error



AGL LISI(St)SI KCA IEC 2 x 1.5

acc. to DIN IEC 60584

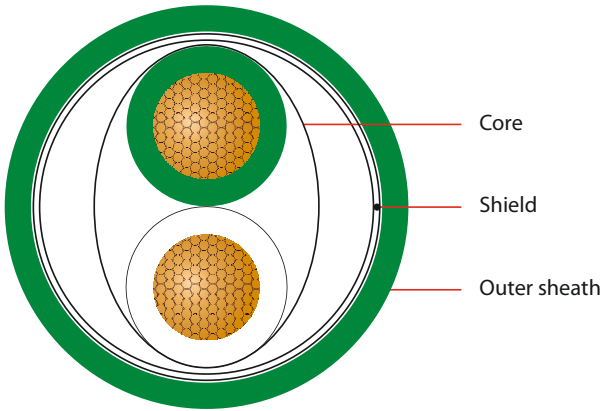

No. of cores and cross section	Diameter approx. mm	Cable weight approx. kg/km	Copper index kg/km
2 x 1.5	7.5	73	4.8

APPLICATION

Compensation cable KCA for temperature sensors

CONSTRUCTION

Conductor: compensation alloy for NiCr-Ni, KCA IEC (Fe-CuNi);
48 x 0.2 mm = 1.5 mm²

Core insulation: silicone rubber (2G); wall thickness 0.5 mm

Core identification: green (+) and white (-)

Lapping: polyester tape

Shield: tinned drain wire (Ø 0.8 mm); plastic-laminated aluminium foil

Outer sheath: silicone rubber (2G); colour: green

ELECTRICAL CHARACTERISTICS

Test voltage 500 V

THERMAL & MECHANICAL PROPERTIES

Operating temperature -50°C to +180°C

Subject to changes due to technical progress and error



AGL LISOSICSOSI KCA (IEC,DIN) n x 0.75

acc. to DIN IEC 60584/DIN 43714

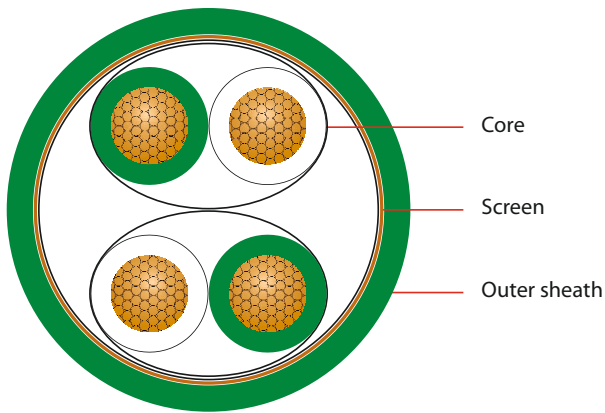

No. of cores and cross section	Diameter approx. mm	Cable weight approx. kg/km	Copper index kg/km
4 x 0.75	7.5	92	34
6 x 0.75	9.0	131	37

APPLICATION

Compensation cable KCA for temperature sensors (FRNC)

CONSTRUCTION

Conductor: compensation alloy for NiCr-Ni, KCA or DIN (Fe-CuNi);
24 x 0.2 mm = 0.75 mm²

Core insulation: notch-tight silicone rubber (2G) FRNC;
approx. Ø 2.1 mm

Core identification:

IEC: green (+) and white (-), pairs with bar code

DIN: red (+) and green (-), pairs with bar code

Lapping: polyester tape

Screen: tinned copper wire braid; optical coverage approx. 85 %

Outer sheath: notch-tight silicone rubber (2G) FRNC; colour: green

ELECTRICAL CHARACTERISTICS

Test voltage 500 V

THERMAL & MECHANICAL PROPERTIES

Operating temperature -90°C to +180°C

Subject to changes due to technical progress and error



AGL LISOSICSOSI KCA IEC

n x 2 x 0.75

acc. to DIN IEC 60584

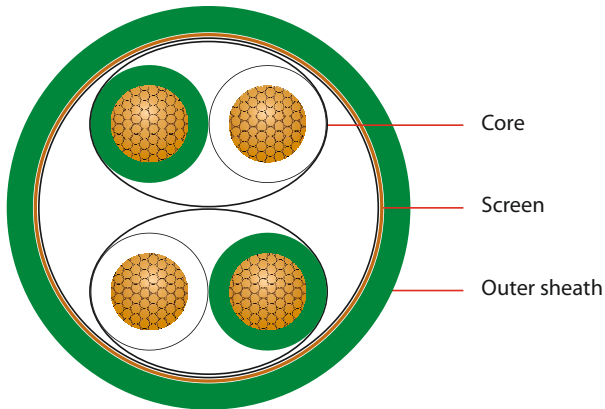

APPLICATION

Compensation cable KCA for temperature sensors (FRNC)

CONSTRUCTION

Conductor: compensation alloy for NiCr-Ni, KCA IEC (Fe-CuNi);
 $24 \times 0.2 \text{ mm} = 0.75 \text{ mm}^2$

Core insulation: notch-tight silicone rubber (2G) FRNC;
 approx. $\varnothing 2.1 \text{ mm}$

Core identification: green (+) and white (-)
 from 2 x 2 x 0.75: additional pairs with bar code

Lapping: polyester tape

Screen: tinned copper wire braid; optical coverage approx. 85 %

Outer sheath: notch-tight silicone rubber (2G) FRNC; colour: green

No. of cores and cross section	Diameter approx. mm	Cable weight approx. kg/km	Copper index kg/km
1 x 2 x 0.75	6.3	52	19.4
2 x 2 x 0.75	9.7	146	33.6
3 x 2 x 0.75	11.7	170	37.2

ELECTRICAL CHARACTERISTICS

Test voltage 500 V

THERMAL & MECHANICAL PROPERTIES

Operating temperature -90°C to +180°C

Subject to changes due to technical progress and error





T.K. Kabel oHG



T.K. Kabel oHG · Geschwister-Scholl-Straße 11 · 71384 Weinstadt

Phone +49 (0) 7151/60 68 70 · Fax +49 (0) 7151/60 91 00 · info@tk-kabel.de · www.tk-kabel.de



T.K. Kabel oHG

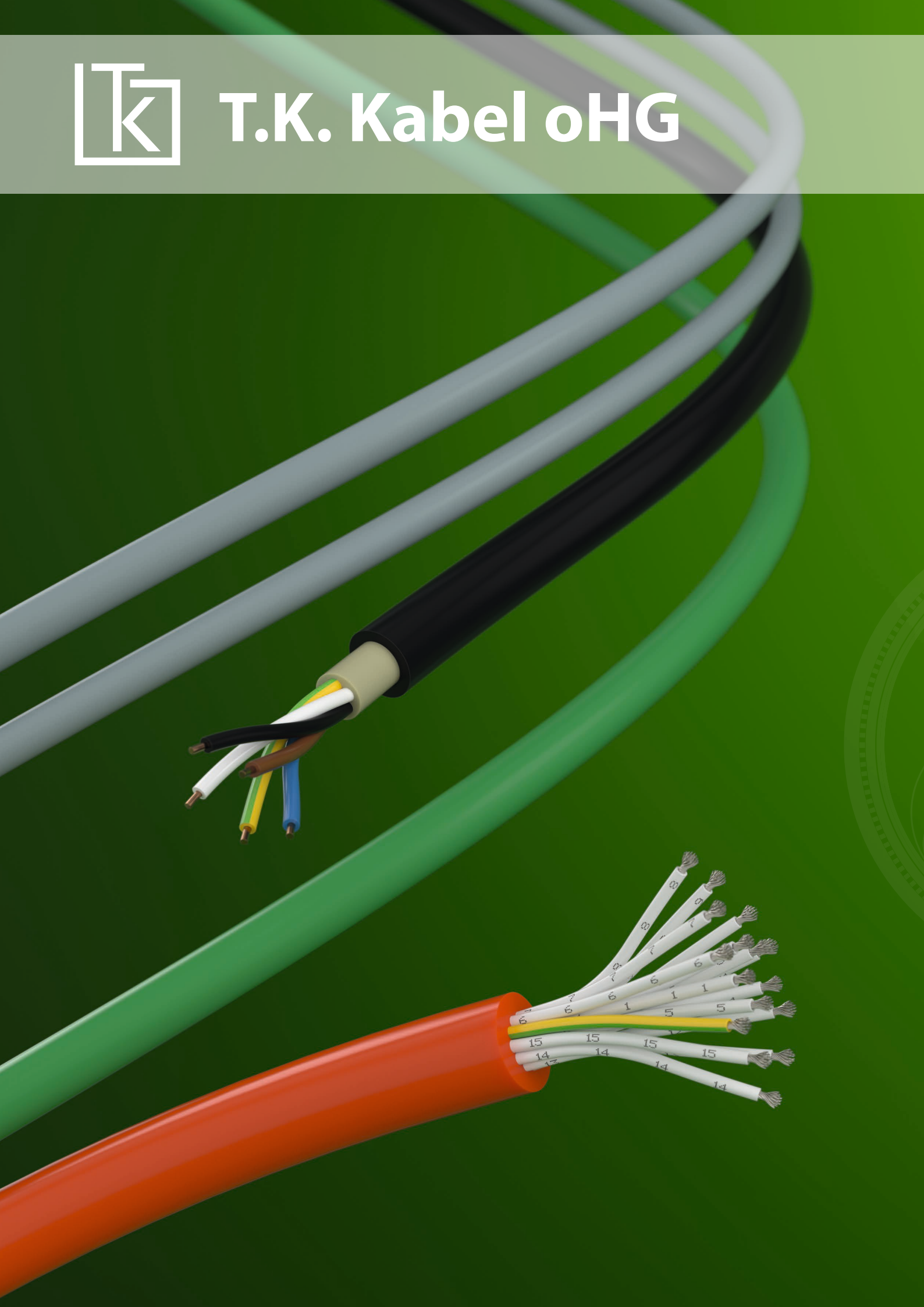

Thermo cables

THL LI7YC7Y TX IEC n x 2 x 0.75	124
THL LI7YC7Y EX IEC n x 2 x 0.75	125
THL LI7YC7Y JX IEC n x 2 x 0.75	126
THL LI7YC7Y S7Y JX IEC n x 2 x 0.75	127
THL LI6YC6Y NX IEC n x 2 x 0.75	128
THL LISOSICSOSI EX IEC n x 2 x 0.75	129
	130

THL LIYCY KX IEC n x 1.5

acc. to DIN IEC 60584

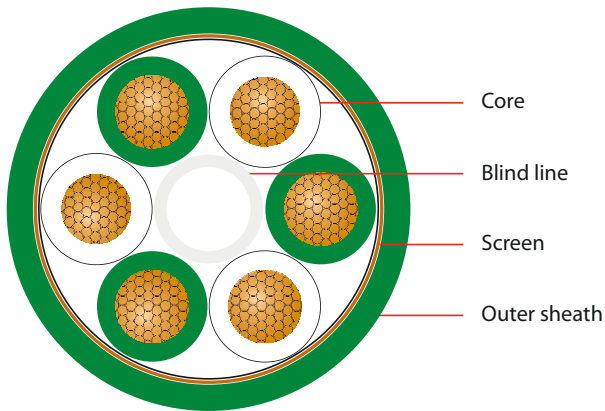

No. of cores and cross section	Diameter approx. mm	Cable weight approx. kg/km	Copper index kg/km
6 x 1.5	11.1	215	48
12 x 1.5	14.7	380	65
24 x 1.5	19.5	660	98
48 x 1.5	26.1	1210	130

APPLICATION

Thermo extension cable KX for temperature sensors

CONSTRUCTION

Conductor: thermo extension alloy NiCr-Ni, KX IEC;
 $48 \times 0.2 \text{ mm} = 1.5 \text{ mm}^2$

Core insulation: PVC; approx. \varnothing 2.6 mm

Core identification: green (+) and white (-), surface marked

Filler: only for 6 x 1.5 cores bunched around a blind line

Lapping: polyester tape

Screen: tinned copper wire braid;
 optical coverage approx. 85%

Outer sheath: PVC; colour: green

ELECTRICAL CHARACTERISTICS

Test voltage 500 V

THERMAL & MECHANICAL PROPERTIES

Operating temperature -50°C to +70°C

Subject to changes due to technical progress and error



THL LI7YC7Y TX IEC n x 2 x 0.75

acc. to DIN IEC 60584

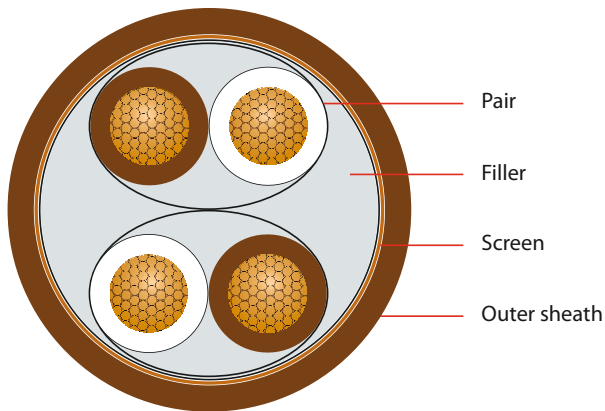

APPLICATION

Thermo extension cable TX for temperature sensors

CONSTRUCTION

Conductor: thermo extension alloy Cu-CuNi, TX IEC;
24 x 0.2 mm = 0.75 mm²

Core insulation: ETFE; wall thickness 0.25 mm; approx. Ø 1.65 mm

Core identification: brown (+) and white (-),
from 2 x 2 x 0.75: additional pairs with bar code

Filler: silicone rubber (round shaping)

Lapping: polyester tape

Screen: tinned copper wire braid;
optical coverage approx. 85%

Outer sheath: ETFE; colour: brown

No. of cores and cross section	Sheath thickness approx. mm	Diameter approx. mm	Cable weight approx. kg/km	Copper index kg/km
1 x 2 x 0.75	0.4	4.8	48	13.2
2 x 2 x 0.75	0.4	7.3	99	21.8
3 x 2 x 0.75	0.6	7.7	149	24.3
4 x 2 x 0.75	0.5	8.7	153	33.8
8 x 2 x 0.75	0.6	11.2	306	41

ELECTRICAL CHARACTERISTICS

Test voltage 500 V

THERMAL & MECHANICAL PROPERTIES

Operating temperature -90°C to +155°C

Subject to changes due to technical progress and error



THL LI7YC7Y EX IEC n x 2 x 0.75

acc. to DIN IEC 60584

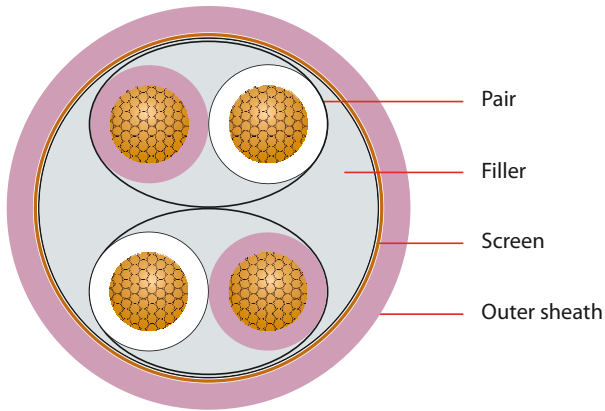

No. of cores and cross section	Sheath thickness approx. mm	Diameter approx. mm	Cable weight approx. kg/km	Copper index kg/km
1 x 2 x 0.75	0.4	4.8	48	13.2
2 x 2 x 0.75	0.4	7.3	99	21.8
3 x 2 x 0.75	0.6	7.7	149	24.3
4 x 2 x 0.75	0.5	8.7	153	33.8
8 x 2 x 0.75	0.6	11.2	306	41

APPLICATION

Thermo extension cable EX for temperature sensors

CONSTRUCTION

Conductor: thermo extension alloy NiCr-CuNi, EX IEC;
24 x 0.2 mm = 0.75 mm²

Core insulation: ETFE, wall thickness 0.25 mm; approx. Ø 1.65 mm

Core identification: purple (+) and white (-),
from 2 x 2 x 0.75: additional pairs with bar code

Lapping: polyester tape

Screen: tinned copper wire braid;
optical coverage approx. 85%

Outer sheath: ETFE; colour: purple

ELECTRICAL CHARACTERISTICS

Test voltage 500 V

THERMAL & MECHANICAL PROPERTIES

Operating temperature -90°C to +155°C

Subject to changes due to technical progress and error



THL LI7YC7Y JX IEC n x 2 x 0.75

acc. to DIN IEC 60584

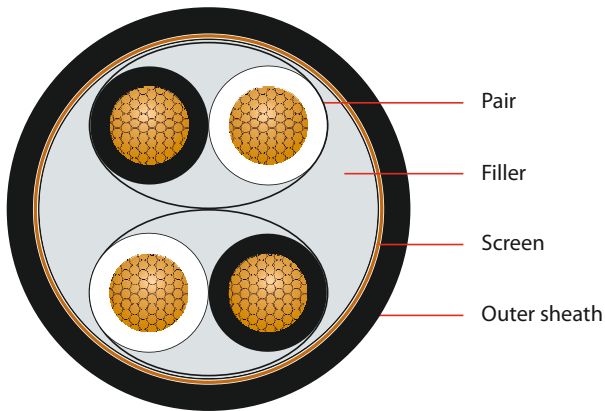

APPLICATION

Thermo extension cable JX for temperature sensors

CONSTRUCTION

Conductor: thermo extension alloy Fe-CuNi, JX IEC;
 $24 \times 0.2 \text{ mm} = 0.75 \text{ mm}^2$

Core insulation: ETFE; wall thickness 0.25 mm; approx. \varnothing 1.65 mm

Core identification: black (+) and white (-),
 from 2 x 2 x 0.75: additional pairs with bar code

Filler: silicone rubber (round shaping)

Lapping: polyester tape

Screen: tinned copper wire braid;
 optical coverage approx. 85 %

Outer sheath: ETFE; colour: black

No. of cores and cross section	Sheath thickness approx. mm	Diameter approx. mm	Cable weight approx. kg/km	Copper index kg/km
1 x 2 x 0.75	0.4	4.8	48	13.2
2 x 2 x 0.75	0.4	7.3	99	21.8
3 x 2 x 0.75	0.6	7.7	149	24.3
4 x 2 x 0.75	0.5	8.7	153	33.8
8 x 2 x 0.75	0.6	11.2	306	41

ELECTRICAL CHARACTERISTICS

Test voltage 500 V

THERMAL & MECHANICAL PROPERTIES

Operating temperature -90°C to +155°C

Subject to changes due to technical progress and error



THL LI7YC7YS7Y JX IEC n x 2 x 0.75

acc. to DIN IEC 60584

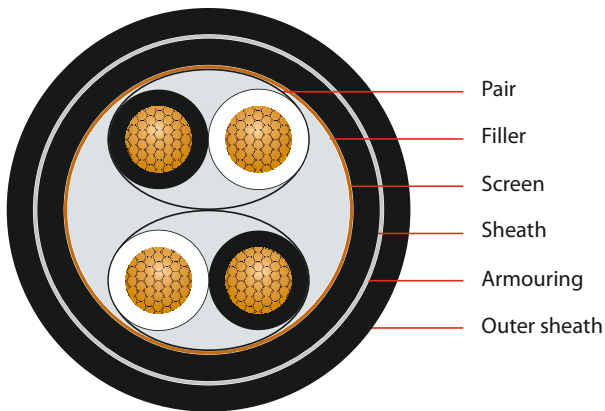

No. of cores and cross section	Sheath thickness approx. mm	Diameter approx. mm	Cable weight approx. kg/km	Copper index kg/km
1 x 2 x 0.75	0.4	6.1	68	13.2
2 x 2 x 0.75	0.5	8.9	150.4	21.8

APPLICATION

Thermo extension cable JX for temperature sensors

CONSTRUCTION

Conductor: thermo extension alloy Fe-CuNi, JX IEC;
24 x 0.2 mm = 0.75 mm²

Core insulation: ETFE; wall thickness 0.25 mm; approx. Ø 1.65 mm

Core identification: black (+) and white (-),
from 2 x 2 x 0.75: additional pairs with bar code

Filler: silicone rubber (round shaping)

Screen: tinned copper wire braid;
optical coverage approx. 85 %

Sheath: ETFE

Armouring: galvanized steel wire braid (Ø 0.2 mm)

Outer sheath: ETFE, colour: black

ELECTRICAL CHARACTERISTICS

Test voltage 500 V

THERMAL & MECHANICAL PROPERTIES

Operating temperature -90°C to +155°C

Subject to changes due to technical progress and error



THL LI6YC6Y NX IEC n x 2 x 0.75

acc. to DIN IEC 60584

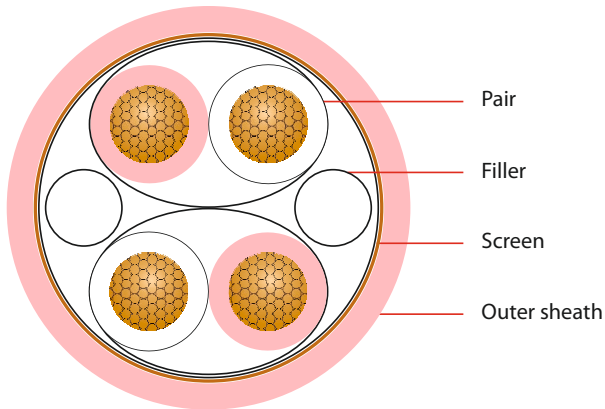

APPLICATION

Thermo extension cable NX for temperature sensors

CONSTRUCTION

Conductor: thermo extension alloy NiCroSil-NiSil, NX IEC;
 $24 \times 0.2 \text{ mm} = 0.75 \text{ mm}^2$

Core insulation: FEP; wall thickness 0.25 mm; approx. \varnothing 1.65 mm

Core identification: pink (+) and white (-);
 from 2 x 2 x 0.75: additional pairs with bar code

Filler: glass fibre

Lapping: polyester tape

Screen: tinned copper wire braid;
 optical coverage approx. 85 %

Outer sheath: FEP; colour: pink

No. of cores and cross section	Sheath thickness approx. mm	Diameter approx. mm	Cable weight approx. kg/km	Copper index kg/km
1 x 2 x 0.75	0.4	5.2	51	13.2
2 x 2 x 0.75	0.4	7.3	85	21.8
3 x 2 x 0.75	0.4	7.6	105	24.3
4 x 2 x 0.75	0.4	8.75	131	29.6

ELECTRICAL CHARACTERISTICS

Test voltage 500 V

THERMAL & MECHANICAL PROPERTIES

Operating temperature -90°C to +205°C

Subject to changes due to technical progress and error



THL LISOSICSOSI EX IEC n x 2 x 0.75

acc. to DIN IEC 60584

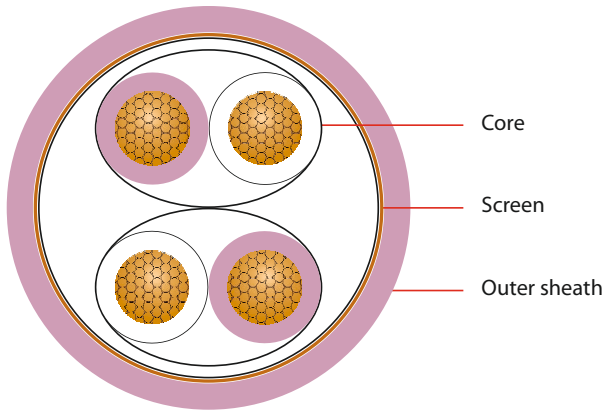

No. of cores and cross section	Diameter approx. mm	Cable weight approx. kg/km	Copper index kg/km
1 x 2 x 0.75	6.3	52	18.1
2 x 2 x 0.75	11.1	146	33.6

APPLICATION

Thermo extension cable EX for temperature sensors (FRNC)

CONSTRUCTION

Conductor: thermo extension alloy NiCr-CuNi, EX IEC; 24 x 0.2 mm = 0.75 mm²

Core insulation: notch-tight silicone rubber (2G) FRNC; approx. Ø 2.1 mm

Core identification: purple (+) and white (-); from 2 x 2 x 0.75: additional pairs with bar code

Lapping: polyester tape

Screen: tinned copper wire braid; optical coverage approx. 85 %

Outer sheath: notch-tight silicone rubber (2G) FRNC; colour: purple

ELECTRICAL CHARACTERISTICS

Test voltage 500 V

THERMAL & MECHANICAL PROPERTIES

Operating temperature -90°C to +180°C

Subject to changes due to technical progress and error





T.K. Kabel oHG



T.K. Kabel oHG · Geschwister-Scholl-Straße 11 · 71384 Weinstadt

Phone +49 (0) 7151/60 68 70 · Fax +49 (0) 7151/60 91 00 · info@tk-kabel.de · www.tk-kabel.de



T.K. Kabel oHG

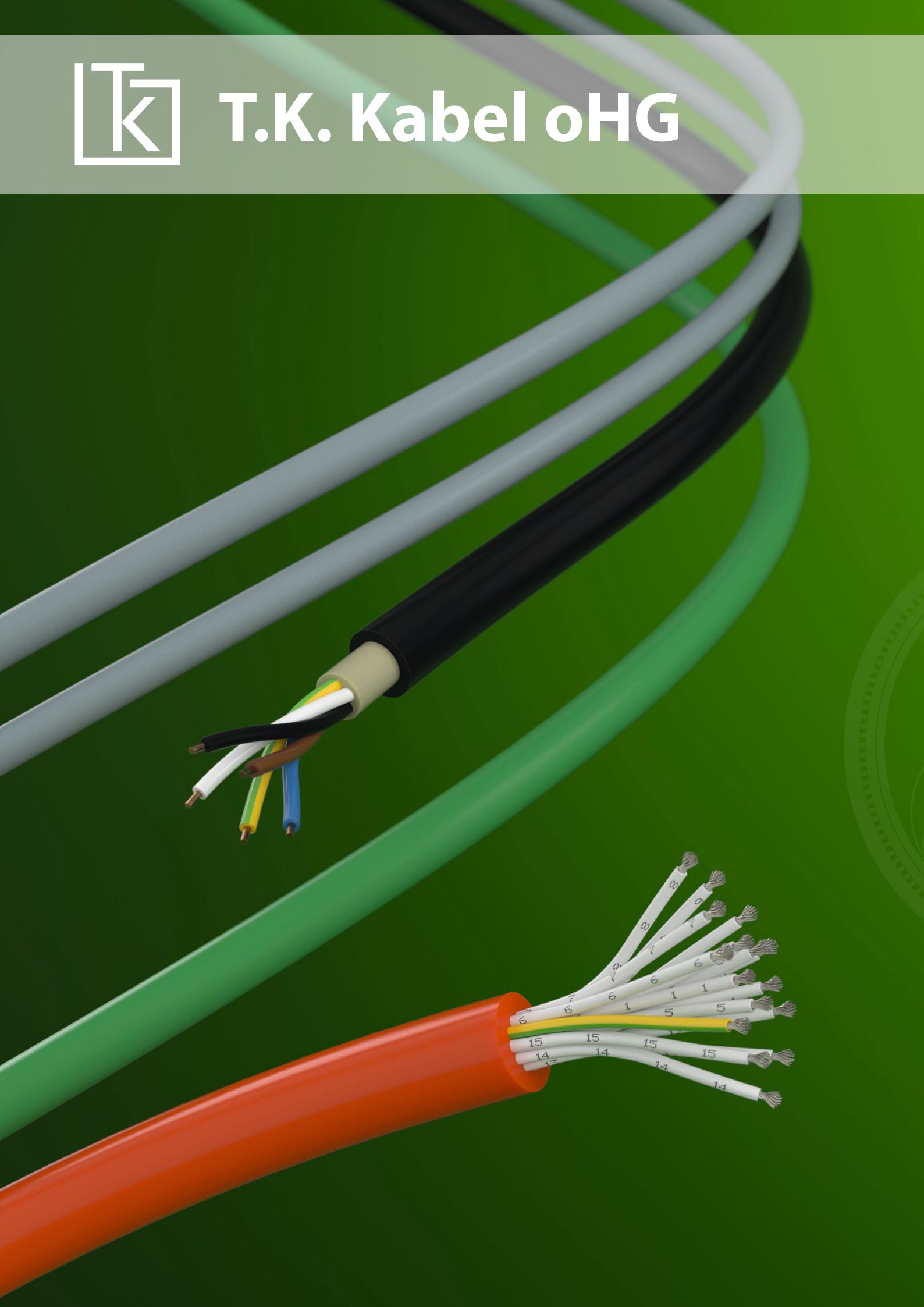

Power cables

NYO-O/J 0.6/1 kV	134
NYO-OZ/JZ 0.6/1 kV	136
NYCY 0.6/1 kV	138
NYCWY 0.6/1 kV	140
<hr/>	
NYYSYö-FR-O/J 0.6/1 kV	141
<hr/>	
2XY-O/J (R2V) 0.6/1kV	142
N2XY-O/J 0.6/1kV	144
N2XCY 0.6/1kV	148
<hr/>	
N2XY-FR-O/J 0.6/1kV	150
<hr/>	
N2XH-O/J 0.6/1kV	154
N2XCH 0.6/1kV	156

NYY-O/J 0.6/1 kV

acc. to VDE 0276-603

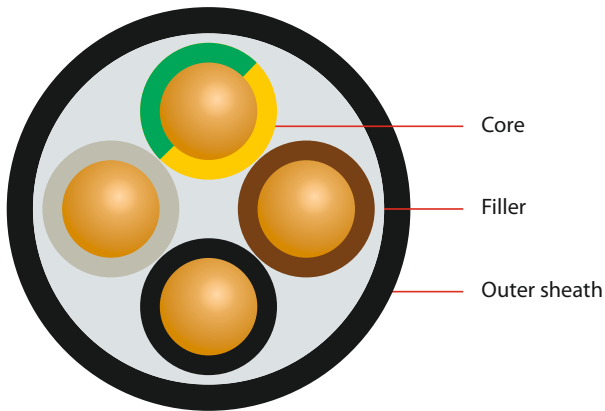

APPLICATION

Power cables for energy supply are installed outdoors, underground, in water, in concrete, indoors, in cable ducts, in power stations, for industry and distribution boards as well as in subscriber networks, where mechanical damage is not to be expected.

CONSTRUCTION

Conductor: copper, bare, single-wire or multi-wire

Core insulation: PVC DIV 4

Core identification: colours acc. to DIN VDE 0293

Core stranding: cores twisted to layers

Outer sheath: PVC DMV 5 flame retardant; colour: black

BEHAVIOUR UNDER FIRE CONDITIONS

Flame retardant: VDE 0482-332-1-2/IEC 60332-1

ELECTRICAL CHARACTERISTICS

Nominal voltage U_0 / U 0.6/1 kV

Test voltage 4 kV

THERMAL & MECHANICAL PROPERTIES

Temperature range during installation -5°C to +50°C

Temperature range stationary -40°C to +70°C

Bending radius single-wire 15 x Diameter

Bending radius multi-wire 12 x diameter

CONDUCTOR TYPES

(acc. to DIN VDE 0295)

RE round, single-wire

RM round, multi-wire

RMv round, multi-wire, compressed SM sectorial form, multi-wire

SMv sectorial form, multi-wire, compressed

No. of cores and cross section		Diameter approx. mm	Cable weight approx. kg/km	Copper index kg/km
NYY-O				
1 x 1.5	RE	7.0	63	14.4
1 x 2.5	RE	7.9	105	24
1 x 4	RE	9.1	110	38
1 x 4	RM	9.1	110	38
1 x 6	RE	9.5	130	58
1 x 10	RE	10.2	180	96
1 x 16	RE	11.2	240	154
1 x 25	RM	12.2	350	240
1 x 35	RM	13.2	460	336
1 x 50	RMv	15.4	600	480
1 x 70	RMv	16.4	800	672
1 x 95	RMv	18.5	1100	912
1 x 120	RMv	20.5	1350	1152
1 x 150	RMv	22.5	1650	1440
1 x 185	RMv	24.6	2000	1776
1 x 240	RMv	27.6	2600	2304
1 x 300	RMv	29.7	3200	2880
1 x 400	RMv	33.8	4100	3840
1 x 500	RMv	38.0	5200	4800
1 x 630	RMv	42.5	6650	6048
2 x 1.5	RE	11.0	170	29
2 x 2.5	RE	12.0	210	48
2 x 4	RE	14.0	290	77
2 x 6	RE	15.2	360	115
2 x 10	RE	16.6	490	192
2 x 16	RE	19.0	660	307
2 x 25	RM	23.0	940	480
3 x 1.5	RE	11.2	190	43
3 x 2.5	RE	12.2	240	72
3 x 4	RE	14.2	330	115
3 x 6	RE	15.2	420	173
3 x 10	RE	17.3	580	288
3 x 25	RM	24.5	1300	720
3 x 35	SM	22.6	1350	1008
3 x 50	SMv	25.6	1800	1440
3 x 95	SMv	33.8	3300	2736
3 x 150	SMv	39.8	4900	4320
3 x 185	SMv	46.0	6500	5328

Subject to changes due to technical progress and error



T.K. Kabel oHG · Geschwister-Scholl-Straße 11 · 71384 Weinstadt

Phone +49 (0) 7151/60 68 70 · Fax +49 (0) 7151/60 91 00 · info@tk-kabel.de · www.tk-kabel.de

No. of cores and cross section		Diameter approx. mm	Cable weight approx. kg/km	Copper index kg/km	No. of cores and cross section		Diameter approx. mm	Cable weight approx. kg/km	Copper index kg/km
NYO-O					NYO-J				
4 x 1.5	RE	12.2	220	58	3 x 120	SMv	35.8	4000	3456
4 x 2.5	RE	13.2	290	96	3 x 150	SMv	39.8	4900	4320
4 x 4	RE	15.3	400	154	3 x 185	SMv	46.0	6500	5328
4 x 6	RE	16.3	510	230	3 x 240	SMv	51.0	8300	6912
4 x 10	RE	18.3	720	384	3 x 16/10	RE	21.2	1030	557
4 x 16	RE	21.4	1050	614	3 x 25/16	RM	24.5	1500	874
4 x 25	RM	25.5	1600	960	3 x 35/16	SM	24.5	1700	1162
4 x 35	SM	27.7	1750	1344	3 x 50/25	SMv	28.7	2300	1680
4 x 50	SMv	29.8	2300	1920	3 x 70/35	SMv	31.7	2800	2352
4 x 70	SMv	33.8	3100	2688	3 x 95/50	SMv	37.8	3800	3216
4 x 95	SMv	38.9	4200	3648	3 x 120/70	SMv	41.0	4700	4128
4 x 120	SMv	42.0	5200	4608	3 x 150/70	SMv	45.0	5600	4992
4 x 150	SMv	47.0	6400	5760	3 x 185/95	SMv	50.0	7400	6240
4 x 185	SMv	52.0	8050	7104	3 x 240/120	SMv	57.0	9600	8064
4 x 240	SMv	58.0	11000	9216	4 x 1.5	RE	12.2	220	58
NYO-J					NYO-O				
1 x 4	RE	9.1	110	38	4 x 2.5	RE	13.2	290	96
1 x 6	RE	9.5	130	58	4 x 4	RE	15.3	400	154
1 x 10	RE	10.2	180	96	4 x 6	RE	16.3	510	230
1 x 16	RE	11.2	240	154	4 x 10	RE	18.3	720	384
1 x 25	RM	12.2	350	240	4 x 16	RE	21.4	1050	614
1 x 35	RM	13.2	460	336	4 x 16	RM	21.4	1050	614
1 x 50	RMv	15.4	600	480	4 x 25	RM	25.5	1600	960
1 x 70	RMv	16.4	800	672	4 x 35	SM	27.7	1750	1344
1 x 95	RMv	18.5	1100	912	4 x 50	SMv	29.8	2300	1920
1 x 120	RMv	20.5	1350	1152	4 x 70	SMv	33.8	3100	2688
1 x 150	RMv	22.5	1650	1440	4 x 95	SMv	38.9	4200	3648
1 x 185	RMv	24.6	2000	1776	4 x 120	SMv	42.0	5200	4608
1 x 240	RMv	27.6	2600	2304	4 x 150	SMv	47.0	6400	5760
1 x 300	RMv	29.7	3200	2880	4 x 185	SMv	52.0	8050	7104
1 x 400	RMv	33.8	4100	3840	4 x 240	SMv	58.0	11000	9216
3 x 1.5	RE	11.2	190	43	4 x 300	SMv	62.4	13127	11520
3 x 2.5	RE	12.2	240	72	5 x 1.5	RE	13.2	270	72
3 x 4	RE	14.2	330	115	5 x 2.5	RE	14.2	350	120
3 x 6	RE	15.2	420	173	5 x 4	RE	16.3	480	192
3 x 10	RE	17.3	580	288	5 x 6	RE	18.3	610	288
3 x 16	RE	19.3	810	461	5 x 10	RE	20.4	880	480
3 x 25	RM	24.5	1300	720	5 x 16	RE	22.4	1250	768
3 x 35	SM	22.6	1400	1008	5 x 25	RM	27.5	1950	1200
3 x 50	SMv	25.6	1800	1440	5 x 35	RM	33.6	2400	1680
3 x 70	SMv	29.7	2400	2016	5 x 50	RMv	40.0	3500	2400
3 x 95	SMv	33.8	3300	2736	5 x 70	RMv	42.4	4450	3360
					5 x 95	RMv	50.0	6134	4560
					5 x 120	RMv	51.3	7483	5760

Subject to changes due to technical progress and error



NYY-OZ/JZ 0.6/1 kV

acc. to VDE 0276-603

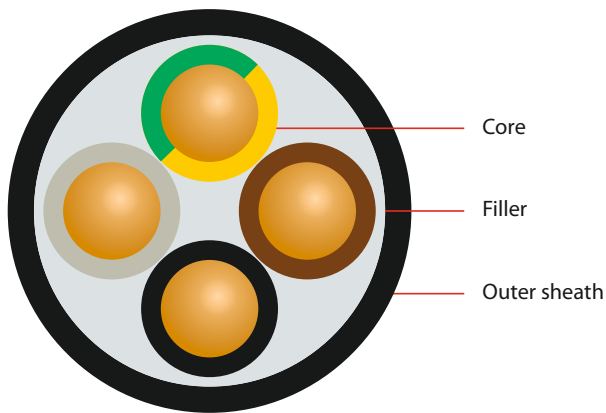

APPLICATION

Power cables for energy supply are installed outdoors, underground, in water, in concrete, indoors, in cable ducts, in power stations, for industry and distribution boards as well as in subscriber networks, where mechanical damage is not to be expected.

CONSTRUCTION

Conductor: copper, bare, single-wire or multi-wire

Core insulation: PVC DIV 4

Core identification: colours acc. to DIN VDE 0293

Core stranding: cores twisted to layers

Outer sheath: PVC DMV 5 flame retardant; colour: black

BEHAVIOUR UNDER FIRE CONDITIONS

Flame retardant: VDE 0482-332-1-2/IEC 60332-1

ELECTRICAL CHARACTERISTICS

Nominal voltage U_0 / U 0.6/1 kV

Test voltage 4 kV

THERMAL & MECHANICAL PROPERTIES

Temperature range during installation -5°C to +50°C

Temperature range stationary -40°C to +70°C

Bending radius single-wire 15 x Diameter

Bending radius multi-wire 12 x diameter

CONDUCTOR TYPES

(acc. to DIN VDE 0295)

RE round, single-wire

RM round, multi-wire

RMv round, multi-wire, compressed SM sectorial form, multi-wire

SMv sectorial form, multi-wire, compressed

No. of cores and cross section		Diameter approx. mm	Cable weight approx. kg/km	Copper index kg/km
NYY-OZ				
5 x 1.5	RE	13.2	270	72
7 x 1.5	RE	16.0	300	101
8 x 1.5	RE	14.2	334	115
10 x 1.5	RE	19.0	360	144
12 x 1.5	RE	19.0	400	173
14 x 1.5	RE	20.0	450	202
16 x 1.5	RE	21.0	500	230
19 x 1.5	RE	22.0	560	274
21 x 1.5	RE	23.0	620	302
24 x 1.5	RE	25.0	700	346
30 x 1.5	RE	26.0	810	432
40 x 1.5	RE	29.0	1050	576
5 x 2.5	RE	14.2	350	120
7 x 2.5	RE	17.0	420	168
8 x 2.5	RE	17.4	480	192
10 x 2.5	RE	20.0	500	240
12 x 2.5	RE	21.0	560	288
14 x 2.5	RE	21.0	630	336
16 x 2.5	RE	22.0	710	384
19 x 2.5	RE	23.0	830	456
21 x 2.5	RE	25.0	910	504
24 x 2.5	RE	27.0	1050	576
30 x 2.5	RE	28.0	1250	720
40 x 2.5	RE	31.0	1650	960
7 x 4	RE	19.0	630	269
10 x 4	RE	23.4	930	384
12 x 4	RE	24.1	1100	461
14 x 4	RE	25.0	1000	538
19 x 4	RE	27.7	1354	730

Subject to changes due to technical progress and error



T.K. Kabel oHG · Geschwister-Scholl-Straße 11 · 71384 Weinstadt

Phone +49 (0) 7151/60 68 70 · Fax +49 (0) 7151/60 91 00 · info@tk-kabel.de · www.tk-kabel.de

No. of cores and cross section		Diameter approx. mm	Cable weight approx. kg/km	Copper index kg/km	No. of cores and cross section	Diameter approx. mm	Cable weight approx. kg/km	Copper index kg/km
NYY-JZ								
7 x 1.5	RE	16.0	300	101				
8 x 1.5	RE	14.2	334	115				
10 x 1.5	RE	19.0	360	144				
12 x 1.5	RE	19.0	400	173				
14 x 1.5	RE	20.0	450	202				
16 x 1.5	RE	21.0	500	230				
19 x 1.5	RE	22.0	560	274				
21 x 1.5	RE	23.0	620	302				
24 x 1.5	RE	25.0	700	346				
30 x 1.5	RE	26.0	810	432				
31 x 1.5	RE	27.0	834	446				
40 x 1.5	RE	29.0	1050	576				
52 x 1.5	RE	32.0	1400	749				
61 x 1.5	RE	34.0	1650	878				
7 x 2.5	RE	17.0	420	168				
10 x 2.5	RE	20.0	500	240				
12 x 2.5	RE	21.0	560	288				
14 x 2.5	RE	21.0	630	336				
16 x 2.5	RE	22.0	710	384				
19 x 2.5	RE	23.0	830	456				
21 x 2.5	RE	25.0	910	504				
24 x 2.5	RE	27.0	1050	576				
30 x 2.5	RE	28.0	1250	720				
40 x 2.5	RE	31.0	1650	960				
52 x 2.5	RE	35.0	2150	1248				
7 x 4	RE	19.0	630	269				
10 x 4	RE	23.0	930	384				
14 x 4	RE	25.0	1000	538				
18 x 4	RE	25.7	1181	691.2				
19 x 4	RE	28.0	1354	730				
7 x 6	RE	21.0	840	403				
14 x 6	RE	25.9	1354	806				
7 x 10	RE	23.0	1150	672				
7 x 25	RM	30.9	2403	1680				
7 x 35	RM	34.7	3191	2352				
7 x 50	RM	40.2	4287	3360				

Subject to changes due to technical progress and error



NYCY 0.6/1 kV

acc. to VDE 0276

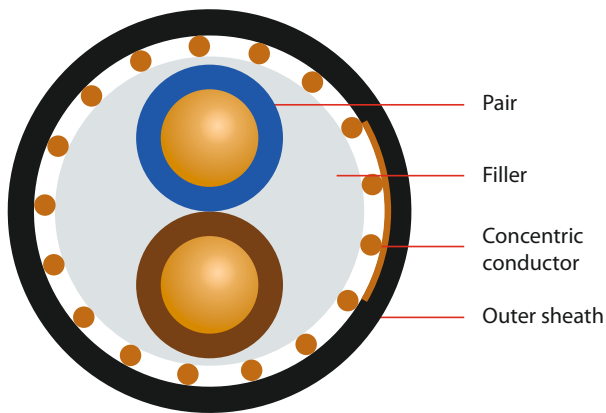

APPLICATION

Power cables for energy supply are used for industry and distribution boards, power stations, house connecting boxes, street lighting as well as a control cable for the transmission of control impulses and test data. Anywhere where increased electrical and mechanical protection is required. These cables are installed outdoors, underground, in water, in concrete, indoors and in cable ducts.

CONSTRUCTION

Conductor: copper, bare, single-wire or multi-wire

Core insulation: PVC DIV 4

Core identification: colours acc. to DIN VDE 0293

Core stranding: cores twisted to layers

Concentric conductor: copper wires, stranded with cu-tape counter helix

Outer sheath: PVC DMV 5 flame retardant; colour: black

BEHAVIOUR UNDER FIRE CONDITIONS

Flame retardant: VDE 0482-332-1-2/IEC 60332-1

ELECTRICAL CHARACTERISTICS

Nominal voltage U_0 / U	0.6/1 kV
Test voltage	4 kV

THERMAL & MECHANICAL PROPERTIES

Temperature range during installation	-5°C to +50°C
Temperature range stationary	-40°C to +70°C
Bending radius single-wire	15 x Diameter
Bending radius multi-wire	12 x diameter

CONDUCTOR TYPES

(acc. to DIN VDE 0295)

RE round, single-wire

RM round, multi-wire

RMv round, multi-wire, compressed SM sectorial form, multi-wire

SMv sectorial form, multi-wire, compressed

No. of cores and cross section		Diameter approx. mm	Cable weight approx. kg/km	Copper index kg/km
2 x 1.5/1.5	RE	13.0	200	52
2 x 2.5/2.5	RE	13.6	260	80
2 x 4/4	RE	15.4	350	123
2 x 6/6	RE	16.9	430	182
2 x 10/10	RE	18.5	520	312
2 x 16/16	RE	20.5	720	489
3 x 1.5/1.5	RE	13.2	220	66
3 x 2.5/2.5	RE	14.2	280	104
3 x 2.5/10	RE	14.4	359	192
3 x 2.5/16	RE		350	240
3 x 4/4	RE	16.3	390	161
3 x 6/6	RE	17.3	500	240
3 x 10/10	RE	20.0	680	408
3 x 16/16	RE	23.0	1010	643
4 x 1.5/1.5	RE	14.2	250	81
4 x 2.5/2.5	RE	15.3	340	128
4 x 4/4	RE	17.3	460	200
4 x 6/6	RE	18.4	580	297
4 x 10/10	RE	21.0	765	504
4 x 16/16	RE	23.0	1060	796
5 x 1.5/1.5	RE	15.0	330	95
5 x 2.5/2.5	RE	16.0	400	152
5 x 4/4	RE	19.0	550	238
5 x 6/6	RE	21.0	700	355
7 x 1.5/2.5	RE	15.3	350	133
7 x 2.5/2.5	RE	17.4	450	200
7 x 4/4	RE	20.0	600	315
7 x 6/6	RE	22.5	790	470
10 x 1.5/2.5	RE	18.4	410	176
10 x 2.5/4	RE	20.4	600	286
10 x 4/6	RE	23.5	900	451
12 x 1.5/2.5	RE	19.4	470	205
12 x 2.5/4	RE	20.5	660	334
12 x 4/6	RE	24.5	1060	528
14 x 1.5/2.5	RE	20.4	520	234
14 x 2.5/6	RE	21.5	750	403
16 x 1.5/4	RE	20.0	620	276
16 x 2.5/6	RE	22.5	800	451
19 x 1.5/4	RE	22.5	660	320
19 x 2.5/6	RE	23.5	940	523
21 x 1.5/6	RE	23.0	790	369
24 x 1.5/6	RE	25.5	850	413
24 x 2.5/10	RE	27.6	1150	696
24 x 4/10	RE	32.3	1813	1042

Subject to changes due to technical progress and error



T.K. Kabel oHG · Geschwister-Scholl-Straße 11 · 71384 Weinstadt

Phone +49 (0) 7151/60 68 70 · Fax +49 (0) 7151/60 91 00 · info@tk-kabel.de · www.tk-kabel.de

No. of cores and cross section		Diameter approx. mm	Cable weight approx. kg/km	Copper index kg/km	No. of cores and cross section		Diameter approx. mm	Cable weight approx. kg/km	Copper index kg/km
NYCY									
30 x 1.5/6	RE	26.5	1020	499					
30 x 2.5/10	RE	29.5	1600	840					
40 x 1.5/10	RE	30.0	1280	696					
40 x 2.5/10	RE	33.0	1660	1080					
52 x 1.5/10	RE	32.0	1600	869					
52 x 2.5/10	RE	35.0	2000	1368					
61 x 1.5/10	RE	33.0	2000	998					
61 x 2.5/10	RE	36.0	2280	1584					

Subject to changes due to technical progress and error



NYCWY 0.6/1 kV

acc. to VDE 0276-603

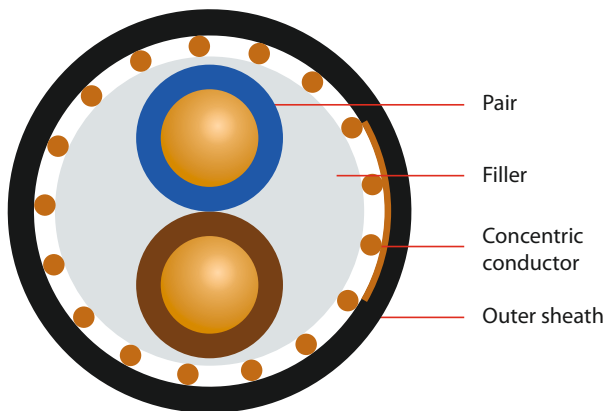

APPLICATION

Power cables for energy supply are used for industry and distribution boards, power stations, house connecting boxes, street lighting as well as a control cable for the transmission of control impulses and test data. Anywhere where increased electrical and also mechanical protection is required. These cables are installed outdoors, underground, in water, in concrete, indoors and in cable ducts.

CONSTRUCTION

Conductor: copper, bare, single-wire or multi-wire

Core insulation: PVC DIV 4

Core identification: colours acc. to DIN VDE 0293

Core stranding: cores twisted to layers

Concentric conductor: copper wires, wave form (ceander), with cu- tape counter helix

Outer sheath: PVC DMV 5 flame retardant; colour: black

BEHAVIOUR UNDER FIRE CONDITIONS

Flame retardant: VDE 0482-332-1-2/IEC 60332-1

ELECTRICAL CHARACTERISTICS

Nominal voltage U_0 / U 0.6/1 kV

Test voltage 4 kV

THERMAL & MECHANICAL PROPERTIES

Temperature range during installation -5°C to +50°C

Temperature range stationary -40°C to +70°C

Bending radius single-wire 15 x Diameter

Bending radius multi-wire 12 x diameter

CONDUCTOR TYPES

(acc. to DIN VDE 0295)

RE round, single-wire

RM round, multi-wire

RMv round, multi-wire, compressed SM sectorial form, multi-wire

SMv sectorial form, multi-wire, compressed

No. of cores and cross section		Diameter approx. mm	Cable weight approx. kg/km	Copper index kg/km
1 x 95	RM	24.0	1761	1472
1 x 240	RM	32.6	4067	3634
2 x 10/10	RE	19.4	610	312
2 x 16/16	RE	20.4	840	489
2 x 25	SM	25.1	1340	763
2 x 50	RM	30.3	2045	1243
3 x 10/10	RE	19.4	750	408
3 x 16/16	RE	21.4	1050	643
3 x 25/16	RM	25.5	1600	902
3 x 35/16	SM	27.6	1700	1190
3 x 50/25	SMv	28.7	2300	1723
3 x 70/35	SMv	32.8	2900	2410
3 x 95/50	SMv	37.8	4000	3296
3 x 120/70	SMv	40.8	5000	4236
3 x 150/70	SMv	45.0	6000	5100
3 x 185/95	SMv	50.0	7500	6383
3 x 240/120	SMv	57.0	10000	8242
3 x 25/25	RM	25.5	1600	1003
3 x 35/35	SM	25.7	1850	1402
3 x 50/50	SMv	28.7	2400	2000
3 x 70/70	SMv	33.8	3300	2796
3 x 95/95	SMv	37.8	4500	3791
3 x 120/120	SMv	41.8	5500	4786
3 x 150/150	SMv	46.0	6750	5970
4 x 10/10	RE	20.4	870	504
4 x 16/16	RE	23.4	1250	796
4 x 16	RM	23.4	1250	796
4 x 25/16	RM	27.6	1800	1142
4 x 35/16	SM	28.6	2050	1526
4 x 50/25	SMv	32.8	2700	2203
4 x 70/35	SMv	36.8	3750	3082
4 x 95/50	SMv	43.9	5000	4208
4 x 120/70	SMv	47.0	6300	5388
4 x 150/70	SMv	51.0	7600	6540
4 x 185/95	SMv	56.0	9300	8159
4 x 240/120	SMv	63.0	11600	10546
4 x 300/150	RMv	69.6	15331	13170

Subject to changes due to technical progress and error



T.K. Kabel oHG · Geschwister-Scholl-Straße 11 · 71384 Weinstadt

Phone +49 (0) 7151/60 68 70 · Fax +49 (0) 7151/60 91 00 · info@tk-kabel.de · www.tk-kabel.de

NYYSYÖ-FR-O/J 0.6/1 kV

in resemblance VDE 0276-603

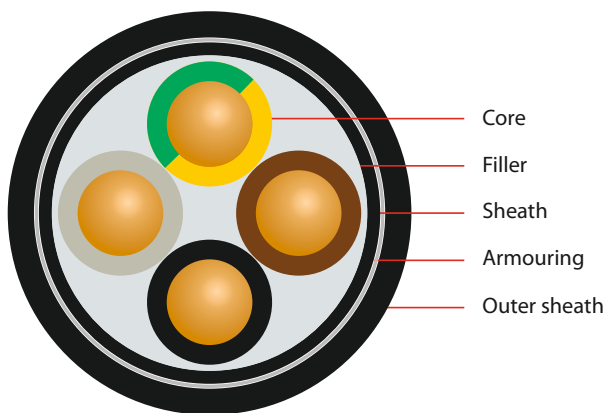

APPLICATION

Power cables for energy supply are installed outdoors, underground, in water, in concrete, indoors, in cable ducts, in power stations, for industry and distribution boards as well as in subscriber networks, where mechanical damage is not to be expected. Resistant to impact of oils.

CONSTRUCTION

Conductor: copper, bare, single-wire or multi-wire

Core insulation: PVC acc. to VDE 0207

Core identification: colours acc. to DIN VDE 0293

Core stranding: cores twisted to layers

Sheath: PVC

Armouring: galvanized steel wire braid (Ø 0.2 mm); optical coverage approx. 80 %

Outer sheath: PVC-FR; oil-resistant acc. DIN EN 60811-404, VDE 0473-811-404 edition 2012; colour: black

BEHAVIOUR UNDER FIRE CONDITIONS

Fire retardant: IEC 60332-3-24, DIN EN 60332-3-24

Low smoke and fume

ELECTRICAL CHARACTERISTICS

Nominal voltage U_0 / U 0.6/1 kV

Test voltage 4 kV

THERMAL & MECHANICAL PROPERTIES

Temperature range during installation -5°C to +50°C

Temperature range stationary -40°C to +70°C

Bending radius stationary 15 x diameter

CONDUCTOR TYPES

(acc. to DIN VDE 0295)

RE round, single wire

No. of cores and cross section		Diameter approx. mm	Cable weight approx. kg/km	Copper index kg/km
2 x 1.5	RE	11.0	335	29
3 x 1.5	RE	11.5	365	43
3 x 2.5	RE	12.5	432	72
4 x 1.5	RE	12.0	405	58
5 x 1.5	RE	13.0	469	72
5 x 2.5	RE	14.5	590	120
7 x 1.5	RE	15.5	540	168
10 x 1.5	RE	18.0	625	240

Subject to changes due to technical progress and error



T.K. Kabel oHG · Geschwister-Scholl-Straße 11 · 71384 Weinstadt

Phone +49 (0) 7151/60 68 70 · Fax +49 (0) 7151/60 91 00 · info@tk-kabel.de · www.tk-kabel.de

2XY-O/J (R2V) 0.6/1kV

acc. to NF C 32-321, IEC 60502

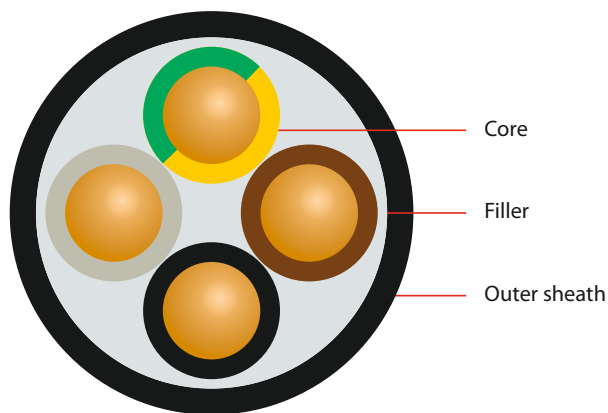
**APPLICATION**

For use on industrial sites. Particularly suited to cases of high operating temperatures and when high resistance to UV radiation and atmospheric agents is required. Good resistance to low temperatures and chemical agents. Can be used without additional mechanical protection in the open air, fixed to walls or in channels, inside gangways or in empty spaces in constructions in general. Can be laid underground with mechanical protection constructed from slabs, tiles, or bricks.

CONSTRUCTION**Conductor:** copper, bare, single-wire or multi-wire**Core insulation:** XLPE (cross-linked polyethylene)**Core identification:** colours acc. to DIN VDE 0293**Core stranding:** cores twisted to layers**Outer sheath:** PVC; colour: black;POINT DE VUE (coloured stripes): 1.5 mm² pink, 2.5 mm² yellow, 4 mm² purple, 6 mm² blue, 10 mm² brown, 16 mm² grey**BEHAVIOUR UNDER FIRE CONDITIONS**

Flame retardant: VDE 0472-804/IEC 60332-1

ELECTRICAL CHARACTERISTICSNominal voltage U_0 / U 0.6/1 kV

Test voltage 3.5 kV

THERMAL & MECHANICAL PROPERTIES

Operating temperature -25°C to +60°C

Temperature at conductor max. +90°C

CONDUCTOR TYPES

(acc. to DIN VDE 0295)

RE round, single-wire

RM round, multi-wire

RMv round, multi-wire, compressed SM sectorial form, multi-wire

SMv sectorial form, multi-wire, compressed

No. of cores and cross section		Diameter approx. mm	Cable weight approx. kg/km	Copper index kg/km
2XY-O				
1 x 1.5	RE	5.4	33	14.4
1 x 2.5	RE	5.8	43	24
1 x 4	RE	6.3	58	38
1 x 6	RM	6.8	81	58
1 x 10	RM	8.1	121	96
1 x 16	RM	9.1	177	154
1 x 25	RM	10.8	268	240
1 x 35	RM	11.9	358	336
1 x 50	RM	13.3	479	480
1 x 70	RM	14.5	673	672
1 x 95	RM	16.4	922	912
1 x 120	RM	18.2	1154	1152
1 x 150	RM	19.9	1415	1440
1 x 185	RM	22.2	1785	1776
1 x 240	RM	25.0	2304	2304
1 x 300	RM	27.5	2888	2880
1 x 400	RM	30.4	3780	3840
1 x 500	RM	32.5	4640	4800
2 x 1.5	RE	9.6	93	29
2 x 2.5	RE	10.4	121	48
2 x 4	RE	11.3	164	77
2 x 6	RM	12.8	229	115
2 x 10	RM	15.3	335	192
2 x 16	RM	17.4	478	307
2 x 25	RM	20.8	729	480
2 x 35	RM	23.4	955	672
3 x 1.5	RE	10.0	108	43
3 x 2.5	RE	10.9	144	72
3 x 4	RE	11.9	198	115
3 x 6	RM	13.5	280	173
3 x 10	RM	16.2	418	288
3 x 16	RM	18.4	608	461
3 x 25	RM	22.1	932	720
3 x 35	RM	24.9	1236	1008
3 x 50	RM	27.9	1657	1440
3 x 95	RM	34.6	3191	2736
3 x 120	RM	39.2	4009	3456
3 x 150	RM	43.1	4942	4320
3 x 185	RM	48.7	6270	5328
3 x 240	RM	54.5	8108	6912

Subject to changes due to technical progress and error



T.K. Kabel oHG · Geschwister-Scholl-Straße 11 · 71384 Weinstadt

Phone +49 (0) 7151/60 68 70 · Fax +49 (0) 7151/60 91 00 · info@tk-kabel.de · www.tk-kabel.de

No. of cores and cross section		Diameter approx. mm	Cable weight approx. kg/km	Copper index kg/km	No. of cores and cross section		Diameter approx. mm	Cable weight approx. kg/km	Copper index kg/km
2XY-O					2XY-J				
4 x 1.5	RE	10.8	128	58	3 x 1.5	RE	10.0	108	43
4 x 2.5	RE	11.7	174	96	3 x 2.5	RE	10.9	144	72
4 x 4	RE	12.9	242	154	3 x 4	RE	11.9	198	115
4 x 6	RM	14.6	344	230	3 x 10	RM	16.2	418	288
4 x 10	RM	17.6	519	384	3 x 16	RM	18.4	608	461
4 x 16	RM	20.1	764	614	3 x 25	RM	22.1	932	720
4 x 25	RM	24.2	1187	960	4 x 1.5	RE	10.8	128	58
4 x 35	RM	27.3	1584	1344	4 x 2.5	RE	11.7	174	96
4 x 50	RM	30.9	2115	1920	4 x 4	RE	12.9	242	154
4 x 70	RM	34.0	2993	2688	4 x 6	RM	14.6	344	230
4 x 95	RM	38.3	4081	3648	4 x 10	RM	17.6	519	384
4 x 120	RM	43.5	5149	4608	4 x 16	RM	20.1	764	614
4 x 150	RM	47.8	6316	5760	4 x 25	RM	24.2	1187	960
4 x 185	RM	53.9	8032	7104	4 x 35	RM	27.3	1584	1344
4 x 240	RM	59.9	10389	9216	4 x 50	RM	30.9	2115	1920
					4 x 70	RM	34.0	2993	2688
					4 x 95	RM	38.3	4081	3648
					5 x 1.5	RE	11.6	150	72
					5 x 2.5	RE	12.6	205	120
					5 x 4	RE	13.9	288	192
					5 x 6	RM	16.6	410	288
					5 x 10	RM	19.1	624	480
					5 x 16	RM	22.0	941	768
					5 x 25	RM	26.5	1454	1200
					5 x 35	RM	29.9	1960	1680
					7 x 1.5	RE	12.4	188	101
					7 x 2.5	RE	13.6	264	168
					12 x 1.5	RE	15.6	287	173
					12 x 2.5	RE	17.3	412	288
					19 x 1.5	RE	18.0	420	274
					19 x 2.5	RE	20.0	613	456
					24 x 1.5	RE	20.8	525	346
					27 x 1.5	RE	21.2	625	389
					27 x 2.5	RE	23.9	833	648
					37 x 1.5	RE	23.6	760	533
					37 x 2.5	RE	26.4	1128	888

Subject to changes due to technical progress and error



N2XY-O/J 0.6/1kV

acc. to VDE 0276-603

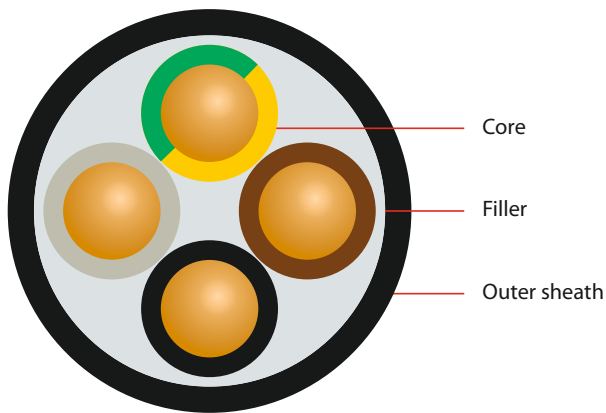
**APPLICATION**

For indoor and outdoor installation, in the ground, for power stations, industry and distribution boards or subscriber networks, where protection against contact voltage is required in the case of mechanical damage. (See DIN VDE 0298-1.) The core insulation of XLPE allows a higher operating temperature than a comparable cable with PVC core insulation.

CONSTRUCTION**Conductor:** copper, bare, single-wire or multi-wire**Core insulation:** XLPE (cross-linked polyethylene)**Core identification:** colours acc. to DIN VDE 0293**Core stranding:** cores twisted to layers**Outer sheath:** PVC; colour: black**ELECTRICAL CHARACTERISTICS**Nominal voltage U_0 / U 0.6/1 kV

Test voltage 4 kV

THERMAL & MECHANICAL PROPERTIES

Operating temperature -5°C to +90°C

Temperature at conductor max. +90°C

CONDUCTOR TYPES

(acc. to DIN VDE 0295)

RE round, single-wire

RM round, multi-wire

RMv round, multi-wire, compressed SM sectorial form, multi-wire

SMv sectorial form, multi-wire, compressed

No. of cores and cross section		Diameter approx. mm	Cable weight approx. kg/km	Copper index kg/km
N2XY-O				
1 x 6	RE	9.0	125	58
1 x 10	RE	10.0	170	96
1 x 16	RE	11.0	235	154
1 x 25	RM	13.0	340	240
1 x 35	RM	14.0	440	336
1 x 50	RM	15.0	565	480
1 x 70	RM	17.0	775	672
1 x 95	RM	19.0	1030	912
1 x 120	RM	20.0	1270	1152
1 x 150	RM	22.0	1545	1440
1 x 185	RM	24.0	1905	1776
1 x 240	RM	27.0	2450	2304
1 x 300	RM	29.0	3020	2880
1 x 400	RM	32.0	3900	3840
1 x 500	RM	36.0	4940	4788
1 x 630	RM	41.0	6195	6048
1 x 800	RM	48.0	8160	7895
3 x 1.5	RE	12.0	215	43
3 x 2.5	RE	13.0	260	72
3 x 4	RE	14.0	330	115
3 x 6	RE	16.0	415	173
3 x 10	RE	17.0	575	288
3 x 16	RE	19.0	785	461
3 x 25	RM	25.0	1230	720
3 x 35	SM	25.0	1375	1008
3 x 50	SM	27.0	1800	1440
3 x 70	SM	31.0	2435	2016
3 x 95	SM	34.0	3280	2736
3 x 120	SM	38.0	4025	3456
3 x 150	SM	42.0	4985	4320
3 x 185	SM	47.0	6150	5328
3 x 240	SM	52.0	7915	6912
3 x 25/16	RM/RE	27.0	1490	874
3 x 35/16	RM/RE	28.0	1825	1162
3 x 50/25	SM/RM	30.0	2185	1680
3 x 70/35	SM/RM	35.0	3010	2352
3 x 95/50	SM/RM	39.0	4020	3216
3 x 120/70	SM/RM	43.0	5010	4128
3 x 150/70	SM/RM	48.0	6090	4992
3 x 185/95	SM/RM	53.0	7635	6240
3 x 240/120	SM/RM	59.0	9805	8064
3 x 300/150	SM/RM	65.0	12100	10080

Subject to changes due to technical progress and error



T.K. Kabel oHG · Geschwister-Scholl-Straße 11 · 71384 Weinstadt

Phone +49 (0) 7151/60 68 70 · Fax +49 (0) 7151/60 91 00 · info@tk-kabel.de · www.tk-kabel.de

No. of cores and cross section		Diameter approx. mm	Cable weight approx. kg/km	Copper index kg/km	No. of cores and cross section		Diameter approx. mm	Cable weight approx. kg/km	Copper index kg/km
N2XY-O					N2XY-J				
4 x 1.5	RE	13.0	250	58	3 x 1.5	RE	12.0	215	43
4 x 2.5	RE	14.0	300	96	3 x 2.5	RE	13.0	260	72
4 x 4	RE	15.0	395	154	3 x 4	RE	14.0	325	115
4 x 6	RE	17.0	500	230	3 x 6	RE	15.0	405	173
4 x 10	RE	19.0	700	384	3 x 10	RE	17.0	565	288
4 x 16	RE	21.0	980	614	3 x 16	RE	19.0	780	461
4 x 16	RM	23.0	1040	614	3 x 25	RM	25.0	1230	720
4 x 25	RM	27.0	1525	960	3 x 35	SM	24.0	1385	1008
4 x 35	SM	27.0	1780	1344	3 x 50	SM	27.0	1790	1440
4 x 50	SM	30.0	2320	1920	3 x 70	SM	30.0	2425	2016
4 x 70	SM	35.0	3195	2688	3 x 95	SM	34.0	3265	2736
4 x 95	SM	39.0	4270	3648	3 x 120	SM	38.0	4000	3561
4 x 120	SM	43.0	5335	4608	3 x 150	SM	42.0	4945	4320
4 x 150	SM	48.0	6515	5760	3 x 185	SM	46.0	6100	5328
4 x 185	SM	53.0	8090	7104	3 x 240	SM	52.0	7900	6912
5 x 1.5	RE	14.0	285	72	4 x 1.5	RE	13.0	250	58
5 x 2.5	RE	15.0	355	120	4 x 2.5	RE	14.0	300	96
5 x 4	RE	16.0	460	192	4 x 4	RE	15.0	385	154
5 x 6	RE	18.0	590	288	4 x 6	RE	17.0	490	230
5 x 10	RE	20.0	845	480	4 x 10	RE	19.0	690	384
5 x 16	RE	23.0	1185	768	4 x 16	RE	21.0	965	614
5 x 16	RM	24.0	1255	768	4 x 16	RM	22.0	1005	614
7 x 1.5	RE	15.0	330	101	4 x 25	RM	26.0	1470	960
7 x 2.5	RE	16.0	415	168	4 x 35	SM	27.0	1770	1362
7 x 4	RE	18.0	550	269	4 x 50	SM	30.0	2310	1920
10 x 1.5	RE	18.0	440	144	4 x 70	SM	35.0	3185	2688
10 x 2.5	RE	19.0	565	240	4 x 95	SM	39.0	4255	3648
10 x 4	RE	21.0	770	384	4 x 120	SM	43.0	5320	4608
12 x 1.5	RE	18.0	480	173	4 x 150	SM	48.0	6465	5760
12 x 2.5	RE	20.0	620	288	4 x 185	SM	53.0	8070	7104
12 x 4	RE	22.0	855	461	4 x 240	SM	59.0	10425	9216
14 x 1.5	RE	19.0	530	202	4 x 300	SM	64.0	12880	11520
14 x 2.5	RE	21.0	690	336	5 x 1.5	RE	14.0	285	72
14 x 4	RE	23.0	960	538	5 x 2.5	RE	15.0	355	120
19 x 1.5	RE	21.0	645	274	5 x 4	RE	16.0	450	192
19 x 2.5	RE	23.0	835	456	5 x 6	RE	18.0	580	288
19 x 4	RE	25.0	1200	731	5 x 10	RE	20.0	825	480
24 x 1.5	RE	24.0	800	346	5 x 16	RE	22.0	1160	768
24 x 2.5	RE	26.0	1065	576	5 x 16	RM	24.0	1215	768
30 x 1.5	RE	25.0	925	432	7 x 1.5	RE	15.0	330	101
30 x 2.5	RE	27.0	1245	720	7 x 2.5	RE	16.0	415	168
40 x 1.5	RE	28.0	1155	576	7 x 4	RE	17.0	540	269
40 x 2.5	RE	30.0	1580	960					

Subject to changes due to technical progress and error



No. of cores and cross section		Diameter approx. mm	Cable weight approx. kg/km	Copper index kg/km
N2XY-J				
10 x 1.5	RE	18.0	440	144
10 x 2.5	RE	19.0	565	240
10 x 4	RE	21.0	740	384
12 x 1.5	RE	18.0	480	173
12 x 2.5	RE	20.0	620	288
12 x 4	RE	22.0	825	461
14 x 1.5	RE	19.0	530	202
14 x 2.5	RE	21.0	690	336
14 x 4	RE	23.0	930	538
19 x 1.5	RE	21.0	645	274
19 x 2.5	RE	23.0	855	456
19 x 4	RE	25.0	1165	730
24 x 1.5	RE	24.0	795	346
24 x 2.5	RE	26.0	1055	576
30 x 1.5	RE	25.0	920	432
30 x 2.5	RE	27.0	1235	720
40 x 1.5	RE	27.0	1145	576
40 x 2.5	RE	30.0	1570	960

No. of cores and cross section		Diameter approx. mm	Cable weight approx. kg/km	Copper index kg/km

Subject to changes due to technical progress and error





T.K. Kabel oHG



T.K. Kabel oHG · Geschwister-Scholl-Straße 11 · 71384 Weinstadt

Phone +49 (0) 7151/60 68 70 · Fax +49 (0) 7151/60 91 00 · info@tk-kabel.de · www.tk-kabel.de

N2XCY 0.6/1kV

acc. to VDE 0276-603

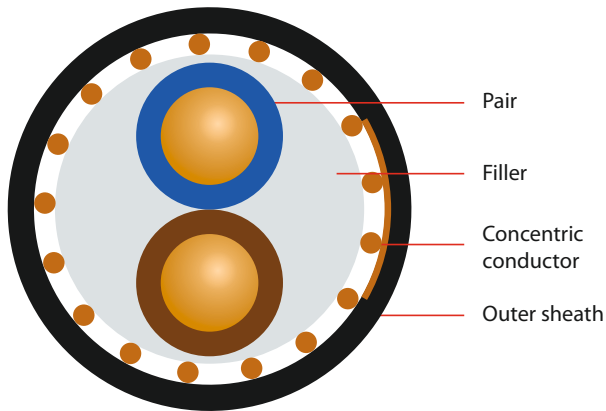

APPLICATION

For indoor and outdoor installation, in the ground, for power stations, industry and distribution boards or subscriber networks, where protection against contact voltage is required in the case of mechanical damage. (See DIN VDE 0298-1.) The core insulation of XLPE allows a higher operating temperature than a comparable cable with PVC core insulation.

CONSTRUCTION

Conductor: copper, bare, single-wire or multi-wire

Core insulation: XLPE (cross-linked polyethylene)

Core identification: colours acc. to DIN VDE 0293

Core stranding: concentric

Concentric Conductor: copper

Outer sheath: PVC; colour: black

ELECTRICAL CHARACTERISTICS

Nominal voltage U_0 / U 0.6/1 kV

Test voltage 4 kV

THERMAL & MECHANICAL PROPERTIES

Operating temperature -5°C to +90°C

Temperature at conductor max. +90°C

Bending radius during installation 12 x Diameter

Bending radius stationary 6 x diameter

BEHAVIOUR UNDER FIRE CONDITIONS

Flame retardant: IEC 60332-1-2

CONDUCTOR TYPES

(acc. to DIN VDE 0295)

RE round, single-wire

RM round, multi-wire

RMv round, multi-wire, compressed SM sectorial form, multi-wire

SMv sectorial form, multi-wire, compressed

No. of cores and cross section		Diameter approx. mm	Cable weight approx. kg/km	Copper index kg/km
1 x 6/6	RE	11.0	210	124
1 x 10/10	RE	12.0	290	202
1 x 16/16	RE	13.0	410	322
1 x 16/16	RM	14.0	420	322
1 x 25/16	RM	15.0	525	405
1 x 35/16	RM	17.0	640	504
1 x 50/25	RM	17.0	825	743
1 x 70/35	RM	20.0	1135	1040
1 x 95/50	RM	22.0	1500	1437
1 x 120/70	RM	24.0	1930	1869
1 x 150/70	RM	26.0	2215	2175
1 x 185/95	RM	29.0	2830	2770
1 x 240/120	RM	32.0	3600	3562
1 x 300/150	RM	35.0	4455	4511
2 x 1.5/1.5	RE	14.0	225	56
2 x 2.5/2.5	RE	14.0	285	80
2 x 4/4	RE	15.0	355	123
3 x 1.5/1.5	RE	14.0	255	66
3 x 2.5/2.5	RE	15.0	310	104
3 x 4/4	RE	16.0	395	161
3 x 6/6	RE	17.0	500	240
3 x 10/10	RE	19.0	700	408
3 x 16/16	RE	22.0	970	648
3 x 25/16	RM	27.0	1420	902
3 x 35/16	SM	27.0	1590	1180
3 x 50/25	SM	30.0	2080	1713
3 x 70/35	SM	34.0	2825	2400
3 x 95/50	SM	38.0	3795	3286
3 x 120/70	SM	42.0	4740	4236
3 x 150/70	SM	47.0	5745	5100
3 x 185/95	SM	52.0	7170	6350
3 x 240/120	SM	56.0	9160	8242
4 x 1.5/1.5	RE	15.0	290	81
4 x 2.5/2.5	RE	16.0	350	128
4 x 4/4	RE	17.0	460	200
4 x 6/6	RE	18.0	585	297
4 x 10/10	RE	21.0	825	484
4 x 16/16	RE	23.0	1160	796
4 x 25/16	RM	27.0	1650	1142
4 x 35/16	SM	30.0	1975	1526
4 x 50/25	SM	33.0	2605	2203
4 x 70/35	SM	38.0	3600	3082
4 x 95/50	SM	42.0	4790	4208
4 x 120/70	SM	47.0	6050	5388
4 x 150/70	SM	52.0	7290	6540

Subject to changes due to technical progress and error



T.K. Kabel oHG · Geschwister-Scholl-Straße 11 · 71384 Weinstadt

Phone +49 (0) 7151/60 68 70 · Fax +49 (0) 7151/60 91 00 · info@tk-kabel.de · www.tk-kabel.de

No. of cores and cross section		Diameter approx. mm	Cable weight approx. kg/km	Copper index kg/km	No. of cores and cross section	Diameter approx. mm	Cable weight approx. kg/km	Copper index kg/km
N2XCY								
4 x 185/95	SM	58.0	9135	8382				
4 x 240/120	SM	64.0	11765	10546				
5 x 1.5/1.5	RE	16.0	330	95				
5 x 2.5/2.5	RE	17.0	405	152				
5 x 4/4	RE	18.0	525	238				
5 x 6/6	RE	20.0	675	355				
5 x 10/10	RE	22.0	975	600				
5 x 16/16	RE	25.0	1370	950				
5 x 16/16	RM	27.0	1440	950				
7 x 1.5/2.5	RE	16.0	375	133				
7 x 2.5/2.5	RE	17.0	465	200				
7 x 4/4	RE	19.0	615	315				
10 x 1.5/2.5	RE	19.0	495	176				
10 x 2.5/4	RE	21.0	630	286				
10 x 4/6	RE	23.0	855	443				
12 x 1.5/2.5	RE	20.0	535	205				
12 x 2.5/4	RE	21.0	690	334				
12 x 4/6	RE	24.0	945	528				
14 x 1.5/2.5	RE	20.0	580	234				
14 x 2.5/6	RE	22.0	775	403				
14 x 4/6	RE	22.0	1045	619				
16 x 2.5/6	RE	24.0	860	451				
19 x 1.5/4	RE	22.0	710	320				
19 x 2.5/6	RE	24.0	950	523				
19 x 4/10	RE	27.0	1325	826				
24 x 1.5/6	RE	25.0	890	413				
24 x 2.5/10	RE	28.0	1190	696				
30 x 1.5/6	RE	27.0	1020	499				
30 x 2.5/10	RE	29.0	1325	840				
37 x 1.5/6	RE	28.0	1170	612				
40 x 1.5/10	RE	29.0	1285	696				
40 x 2.5/10	RE	32.0	1660	1080				
52 x 2.5/10	RE	36.0	2150	1342				

Subject to changes due to technical progress and error



N2XY-FR-O/J 0.6/1kV Fca

acc. to VDE 0276-603

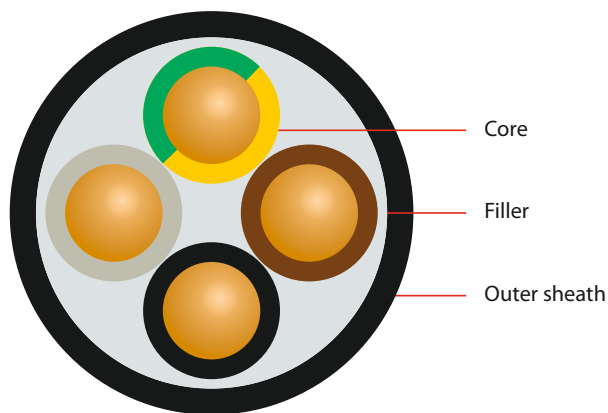

APPLICATION

For indoor and outdoor installation, in the ground, for power stations, industry and distribution boards or subscriber networks, where protection against contact voltage is required in the case of mechanical damage. (See DIN VDE 0298-1.) The core insulation of XLPE allows a higher operating temperature than a comparable cable with PVC core insulation.

CONSTRUCTION

Conductor: copper, bare, single-wire or multi-wire

Core insulation: XLPE (cross-linked polyethylene)

Core identification: colours acc. to DIN VDE 0293

Core stranding: cores twisted to layers

Outer sheath: PVC-FR; colour: black

BEHAVIOUR UNDER FIRE CONDITIONS

Fire retardant: IEC 60332-3-24, DIN EN 60332-3-24

Low smoke and fume

ELECTRICAL CHARACTERISTICS

Nominal voltage U_0 / U 0.6/1 kV

Test voltage 4 kV

THERMAL & MECHANICAL PROPERTIES

Operating temperature -5°C to +90°C

Temperature at conductor max. +90°C

CONDUCTOR TYPES

(acc. to DIN VDE 0295)

RE round, single-wire

RM round, multi-wire

RMv round, multi-wire, compressed SM sectorial form, multi-wire

SMv sectorial form, multi-wire, compressed

No. of cores and cross section		Diameter approx. mm	Cable weight approx. kg/km	Copper index kg/km
N2XY-FR-O				
1 x 6	RE	9.0	125	58
1 x 10	RE	10.0	170	96
1 x 16	RE	11.0	235	154
1 x 25	RM	13.0	340	240
1 x 35	RM	14.0	440	336
1 x 50	RM	15.0	565	480
1 x 70	RM	17.0	775	672
1 x 95	RM	19.0	1030	912
1 x 120	RM	20.0	1270	1152
1 x 150	RM	22.0	1545	1440
1 x 185	RM	24.0	1905	1776
1 x 240	RM	27.0	2450	2304
1 x 300	RM	29.0	3020	2880
1 x 400	RM	32.0	3900	3840
1 x 500	RM	36.0	4940	4788
1 x 630	RM	41.0	6195	6048
1 x 800	RM	48.0	8160	7895
3 x 1.5	RE	12.0	215	43
3 x 2.5	RE	13.0	260	72
3 x 4	RE	14.0	330	115
3 x 6	RE	16.0	415	173
3 x 10	RE	17.0	575	288
3 x 16	RE	19.0	785	461
3 x 25	RM	25.0	1230	720
3 x 35	SM	25.0	1375	1008
3 x 50	SM	27.0	1800	1440
3 x 70	SM	31.0	2435	2016
3 x 95	SM	34.0	3280	2736
3 x 120	SM	38.0	4025	3456
3 x 150	SM	42.0	4985	4320
3 x 185	SM	47.0	6150	5328
3 x 240	SM	52.0	7915	6912
3 x 25/16	RM/RE	27.0	1490	874
3 x 35/16	RM/RE	28.0	1825	1162
3 x 50/25	SM/RM	30.0	2185	1680
3 x 70/35	SM/RM	35.0	3010	2352
3 x 95/50	SM/RM	39.0	4020	3216
3 x 120/70	SM/RM	43.0	5010	4128
3 x 150/70	SM/RM	48.0	6090	4992
3 x 185/95	SM/RM	53.0	7635	6240
3 x 240/120	SM/RM	59.0	9805	8064
3 x 300/150	SM/RM	65.0	12100	10080

Subject to changes due to technical progress and error



T.K. Kabel oHG · Geschwister-Scholl-Straße 11 · 71384 Weinstadt

Phone +49 (0) 7151/60 68 70 · Fax +49 (0) 7151/60 91 00 · info@tk-kabel.de · www.tk-kabel.de

No. of cores and cross section		Diameter approx. mm	Cable weight approx. kg/km	Copper index kg/km	No. of cores and cross section		Diameter approx. mm	Cable weight approx. kg/km	Copper index kg/km
N2XY-FR-O					N2XY-FR-J				
4 x 1.5	RE	13.0	250	58	3 x 1.5	RE	12.0	215	43
4 x 2.5	RE	14.0	300	96	3 x 2.5	RE	13.0	260	72
4 x 4	RE	15.0	395	154	3 x 4	RE	14.0	325	115
4 x 6	RE	17.0	500	230	3 x 6	RE	15.0	405	173
4 x 10	RE	19.0	700	384	3 x 10	RE	17.0	565	288
4 x 16	RE	21.0	980	614	3 x 16	RE	19.0	780	461
4 x 16	RM	23.0	1040	614	3 x 25	RM	25.0	1230	720
4 x 25	RM	27.0	1525	960	3 x 35	SM	24.0	1385	1008
4 x 35	SM	27.0	1780	1344	3 x 50	SM	27.0	1790	1440
4 x 50	SM	30.0	2320	1920	3 x 70	SM	30.0	2425	2016
4 x 70	SM	35.0	3195	2688	3 x 95	SM	34.0	3265	2736
4 x 95	SM	39.0	4270	3648	3 x 120	SM	38.0	4000	3561
4 x 120	SM	43.0	5335	4608	3 x 150	SM	42.0	4945	4320
4 x 150	SM	48.0	6515	5760	3 x 185	SM	46.0	6100	5328
4 x 185	SM	53.0	8090	7104	3 x 240	SM	52.0	7900	6912
5 x 1.5	RE	14.0	285	72	4 x 1.5	RE	13.0	250	58
5 x 2.5	RE	15.0	355	120	4 x 2.5	RE	14.0	300	96
5 x 4	RE	16.0	460	192	4 x 4	RE	15.0	385	154
5 x 6	RE	18.0	590	288	4 x 6	RE	17.0	490	230
5 x 10	RE	20.0	845	480	4 x 10	RE	19.0	690	384
5 x 16	RE	23.0	1185	768	4 x 16	RE	21.0	965	614
5 x 16	RM	24.0	1255	768	4 x 16	RM	22.0	1005	614
7 x 1.5	RE	15.0	330	101	4 x 25	RM	26.0	1470	960
7 x 2.5	RE	16.0	415	168	4 x 35	SM	27.0	1770	1362
7 x 4	RE	18.0	550	269	4 x 50	SM	30.0	2310	1920
10 x 1.5	RE	18.0	440	144	4 x 70	SM	35.0	3185	2688
10 x 2.5	RE	19.0	565	240	4 x 95	SM	39.0	4255	3648
10 x 4	RE	21.0	770	384	4 x 120	SM	43.0	5320	4608
12 x 1.5	RE	18.0	480	173	4 x 150	SM	48.0	6465	5760
12 x 2.5	RE	20.0	620	288	4 x 185	SM	53.0	8070	7104
12 x 4	RE	22.0	855	461	4 x 240	SM	59.0	10425	9216
14 x 1.5	RE	19.0	530	202	4 x 300	SM	64.0	12880	11520
14 x 2.5	RE	21.0	690	336	5 x 1.5	RE	14.0	285	72
14 x 4	RE	23.0	960	538	5 x 2.5	RE	15.0	355	120
19 x 1.5	RE	21.0	645	274	5 x 4	RE	16.0	450	192
19 x 2.5	RE	23.0	835	456	5 x 6	RE	18.0	580	288
19 x 4	RE	25.0	1200	731	5 x 10	RE	20.0	825	480
24 x 1.5	RE	24.0	800	346	5 x 16	RE	22.0	1160	768
24 x 2.5	RE	26.0	1065	576	5 x 16	RM	24.0	1215	768
30 x 1.5	RE	25.0	925	432	7 x 1.5	RE	15.0	330	101
30 x 2.5	RE	27.0	1245	720	7 x 2.5	RE	16.0	415	168
40 x 1.5	RE	28.0	1155	576	7 x 4	RE	17.0	540	269
40 x 2.5	RE	30.0	1580	960					

Subject to changes due to technical progress and error



No. of cores and cross section		Diameter approx. mm	Cable weight approx. kg/km	Copper index kg/km		No. of cores and cross section	Diameter approx. mm	Cable weight approx. kg/km	Copper index kg/km
N2XY-FR-J									
10 x 1.5	RE	18.0	440	144					
10 x 2.5	RE	19.0	565	240					
10 x 4	RE	21.0	740	384					
12 x 1.5	RE	18.0	480	173					
12 x 2.5	RE	20.0	620	288					
12 x 4	RE	22.0	825	461					
14 x 1.5	RE	19.0	530	202					
14 x 2.5	RE	21.0	690	336					
14 x 4	RE	23.0	930	538					
19 x 1.5	RE	21.0	645	274					
19 x 2.5	RE	23.0	855	456					
19 x 4	RE	25.0	1165	730					
24 x 1.5	RE	24.0	795	346					
24 x 2.5	RE	26.0	1055	576					
30 x 1.5	RE	25.0	920	432					
30 x 2.5	RE	27.0	1235	720					
40 x 1.5	RE	27.0	1145	576					
40 x 2.5	RE	30.0	1570	960					

Subject to changes due to technical progress and error





T.K. Kabel oHG



T.K. Kabel oHG · Geschwister-Scholl-Straße 11 · 71384 Weinstadt

Phone +49 (0) 7151/60 68 70 · Fax +49 (0) 7151/60 91 00 · info@tk-kabel.de · www.tk-kabel.de

N2XH-O/J 0.6/1kV

acc. to VDE 0276-604

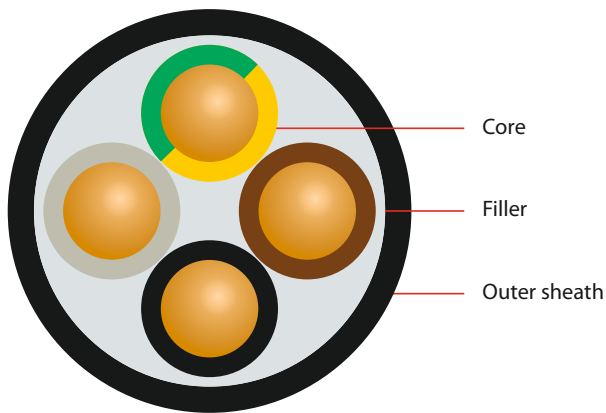

APPLICATION

Low-smoke, zero-halogen, flame retardant power cable. For fixed indoor and outdoor installation. Can be placed in concrete. Not for direct burial in earth or application in water.

CONSTRUCTION

Conductor: copper, bare, single-wire or multi-wire

Core insulation: XLPE (cross-linked polyethylene)

Core identification: colours acc. to DIN VDE 0293

Core stranding: cores twisted to layers

Outer sheath: halogen-free compound; colour: black

BEHAVIOUR UNDER FIRE CONDITIONS

Zero halogen, non corrosive gases: IEC 60754, DIN EN 50267

Fire retardant: IEC 60332-3-24 cat. C, DIN EN 50266-2-4

Smoke density: IEC 61034, DIN EN 61034

ELECTRICAL CHARACTERISTICS

Nominal voltage U_0 / U 0.6/1 kV

Test voltage 4 kV

THERMAL & MECHANICAL PROPERTIES

Temperature during installation -5°C to +70°C

Temperature stationary -30°C to +70°C

Temperature at conductor max. +90°C

Bending radius stationary 12 x diameter

CONDUCTOR TYPES

(acc. to DIN VDE 0295)

RE round, single-wire

RM round, multi-wire

RMv round, multi-wire, compressed SM sectorial form, multi-wire

SMv sectorial form, multi-wire, compressed

No. of cores and cross section		Diameter approx. mm	Cable weight approx. kg/km	Copper index kg/km
N2XH-O				
1 x 4	RE	9.0	140	38
1 x 6	RE	10.0	160	58
1 x 10	RE	11.0	210	96
1 x 16	RE	12.0	270	154
1 x 25	RM	14.0	380	240
1 x 35	RM	15.0	490	336
1 x 50	RMv	16.0	620	480
1 x 70	RMv	18.0	830	672
1 x 95	RMv	20.0	1200	912
1 x 120	RMv	22.0	1275	1152
1 x 150	RMv	24.0	1700	1440
1 x 185	RMv	26.0	2200	1776
1 x 240	RMv	29.0	2750	2304
1 x 300	RMv	30.0	3300	2880
1 x 400	RMv	32.0	4420	3840
1 x 500	RMv	37.0	4866	4800
2 x 1.5	RE	12.0	180	29
2 x 2.5	RE	12.1	210	48
2 x 4	RE	13.0	270	77
2 x 6	RE	14.0	340	115
2 x 10	RE	16.0	450	192
2 x 16	RE	18.0	600	307
2 x 25	RM	23.0	980	480
3 x 1.5	RE	12.0	200	43
3 x 2.5	RE	13.0	225	72
4 x 4	RE	15.0	352	154
4 x 6	RE	16.0	454	230
4 x 10	RE	18.0	647	384
4 x 16	RE	20.0	964	614
4 x 25	RM	26.0	1446	960
4 x 35	SM	29.0	1906	1344
4 x 50	SMv	32.0	2530	1920
4 x 70	SMv	37.0	3418	2688
4 x 95	SMv	41.0	4574	3648
4 x 120	SMv	48.0	5300	4608

Subject to changes due to technical progress and error



T.K. Kabel oHG · Geschwister-Scholl-Straße 11 · 71384 Weinstadt

Phone +49 (0) 7151/60 68 70 · Fax +49 (0) 7151/60 91 00 · info@tk-kabel.de · www.tk-kabel.de

No. of cores and cross section		Diameter approx. mm	Cable weight approx. kg/km	Copper index kg/km	No. of cores and cross section		Diameter approx. mm	Cable weight approx. kg/km	Copper index kg/km
N2XH-J					N2XH-J				
3 x 1.5	RE	12.0	179	43	7 x 1.5	RE	14.0	206	101
3 x 2.5	RE	13.0	225	72	7 x 2.5	RE	15.0	287	168
3 x 4	RE	14.0	291	115	7 x 4	RE	15.0	530	269
3 x 6	RE	15.0	371	173	10 x 1.5	RE	17.0	287	144
3 x 10	RE	16.0	523	288	10 x 2.5	RE	18.0	472	240
3 x 16	RE	20.0	773	461	12 x 1.5	RE	17.0	328	173
3 x 25	RM	22.0	1200	720	14 x 1.5	RE	17.0	383	202
3 x 35	SM	25.0	1600	1008	14 x 2.5	RE	19.0	670	336
3 x 50	SMv	26.0	1800	1440	19 x 1.5	RE	19.0	484	274
3 x 25/16	RM	24.0	1200	874	19 x 2.5	RE	21.0	840	456
3 x 35/16	SM	26.0	1640	1162	24 x 1.5	RE	22.0	603	346
3 x 50/25	SMv	32.0	2200	1680	24 x 2.5	RE	25.0	1050	576
3 x 70/35	SMv	37.0	2950	2352	30 x 1.5	RE	23.0	730	432
3 x 95/50	SMv	41.0	3900	3216	30 x 2.5	RE	26.0	1230	720
3 x 120/70	SMv	45.0	4800	4128	40 x 1.5	RE	26.0	1200	576
3 x 150/70	SMv	49.0	5750	4992					
3 x 185/95	SMv	55.0	7200	6240					
3 x 240/120	SMv	62.0	9150	8064					
4 x 1.5	RE	13.0	208	58					
4 x 2.5	RE	14.0	265	96					
4 x 4	RE	15.0	352	154					
4 x 6	RE	16.0	454	230					
4 x 10	RE	18.0	647	384					
4 x 16	RE	20.0	964	614					
4 x 25	RM	26.0	1446	960					
4 x 35	SM	29.0	1906	1344					
4 x 50	SMv	32.0	2530	1920					
4 x 70	SMv	37.0	3418	2688					
4 x 95	SMv	41.0	4574	3648					
4 x 120	SMv	48.0	5300	4608					
4 x 150	SMv	50.0	6350	5760					
4 x 185	SMv	53.0	7800	7104					
4 x 240	SMv	58.0	10300	9216					
5 x 1.5	RE	14.0	243	72					
5 x 2.5	RE	15.0	310	120					
5 x 4	RE	16.0	413	192					
5 x 6	RE	17.0	536	288					
5 x 10	RE	19.0	776	480					
5 x 16	RE	22.0	1165	768					
5 x 25	RM	25.0	1766	1200					
5 x 35	RM	28.8	2155	1680					

Subject to changes due to technical progress and error



N2XCH 0.6/1kV

acc. to VDE 0276-604

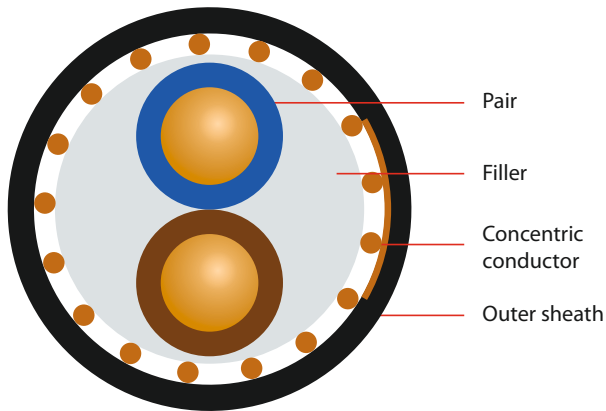

APPLICATION

Low-smoke, zero-halogen, flame retardant power cable. For fixed indoor and outdoor installation. Can be placed in concrete. Not for direct burial in earth or application in water.

CONSTRUCTION

Conductor: copper, bare, single-wire or multi-wire

Core insulation: XLPE (cross-linked polyethylene)

Core identification: colours acc. to DIN VDE 0293

Core stranding: cores twisted to layers

Concentric conductor: copper

Outer sheath: halogen-free compound; colour: black

BEHAVIOUR UNDER FIRE CONDITIONS

Zero halogen, non corrosive gases: IEC 60754, DIN EN 50267

Fire retardant: IEC 60332-3-24 cat. C, DIN EN 50266-2-4

Smoke density: IEC 61034, DIN EN 61034

ELECTRICAL CHARACTERISTICS

Nominal voltage U_0 / U 0.6/1 kV

Test voltage 4 kV

THERMAL & MECHANICAL PROPERTIES

Temperature during installation -5°C to +70°C

Temperature at conductor max. +90°C

Bending radius stationary 12 x diameter

CONDUCTOR TYPES

(acc. to DIN VDE 0295)

RE round, single-wire

RM round, multi-wire

RMv round, multi-wire, compressed SM sectorial form, multi-wire

SMv sectorial form, multi-wire, compressed

No. of cores and cross section		Diameter approx. mm	Cable weight approx. kg/km	Copper index kg/km
2 x 1.5/1.5	RE	12.0	250	52
2 x 2.5/2.5	RE	12.0	280	80
2 x 4/4	RE	14.0	320	123
2 x 6/6	RE	15.0	410	182
2 x 10/10	RE	17.0	550	312
2 x 16/16	RE	19.0	780	489
3 x 1.5/1.5	RE	12.0	250	66
3 x 2.5/2.5	RE	13.0	320	104
3 x 4/4	RE	14.0	400	161
3 x 6/6	RE	16.0	500	240
3 x 10/10	RE	18.0	750	408
3 x 16/16	RE	21.0	1000	643
3 x 25/16	RM	24.0	1600	902
3 x 35/16	SM	27.0	1900	1190
3 x 50/25	SMv	30.0	2400	1723
3 x 70/35	SMv	34.0	2615	2410
3 x 95/50	SMv	38.1	3636	3296
3 x 120/70	SMv	42.5	4606	4236
3 x 150/70	SMv	47.0	5552	5100
3 x 185/95	SMv	50.0	6680	6383
3 x 240/120	SMv	57.1	8964	8242
4 x 1.5/1.5	RE	13.0	235	81
4 x 2.5/2.5	RE	14.0	302	128
4 x 4/4	RE	15.0	411	200
4 x 6/6	RE	17.0	527	297
4 x 10/10	RE	19.0	762	504
4 x 16/16	RE	22.0	1139	796
4 x 25/16	RM	27.0	1634	1142
4 x 35/16	SM	29.0	2080	1526
4 x 50/25	SMv	33.0	2790	2203
4 x 70/35	SMv	41.0	3550	3082
4 x 95/50	SMv	46.0	4800	4208
4 x 120/70	SMv	50.0	6556	5388
4 x 150/70	SMv	55.0	7904	6540
4 x 185/95	SMv	62.0	9950	8159
4 x 240/120	SMv	68.0	12912	10546
5 x 1.5/1.5	RE	14.0	283	95
7 x 1.5/2.5	RE	16.0	380	133
7 x 2.5/2.5	RE	18.0	480	200
7 x 4/4	RE	19.0	650	315
7 x 6/6	RE	20.0	850	470
10 x 2.5/4	RE	18.0	550	286
12 x 1.5/2.5	RE	20.0	550	205
12 x 2.5/4	RE	21.0	750	334

Subject to changes due to technical progress and error



T.K. Kabel oHG · Geschwister-Scholl-Straße 11 · 71384 Weinstadt

Phone +49 (0) 7151/60 68 70 · Fax +49 (0) 7151/60 91 00 · info@tk-kabel.de · www.tk-kabel.de



T.K. Kabel oHG



T.K. Kabel oHG · Geschwister-Scholl-Straße 11 · 71384 Weinstadt

Phone +49 (0) 7151/60 68 70 · Fax +49 (0) 7151/60 91 00 · info@tk-kabel.de · www.tk-kabel.de



T.K. Kabel oHG

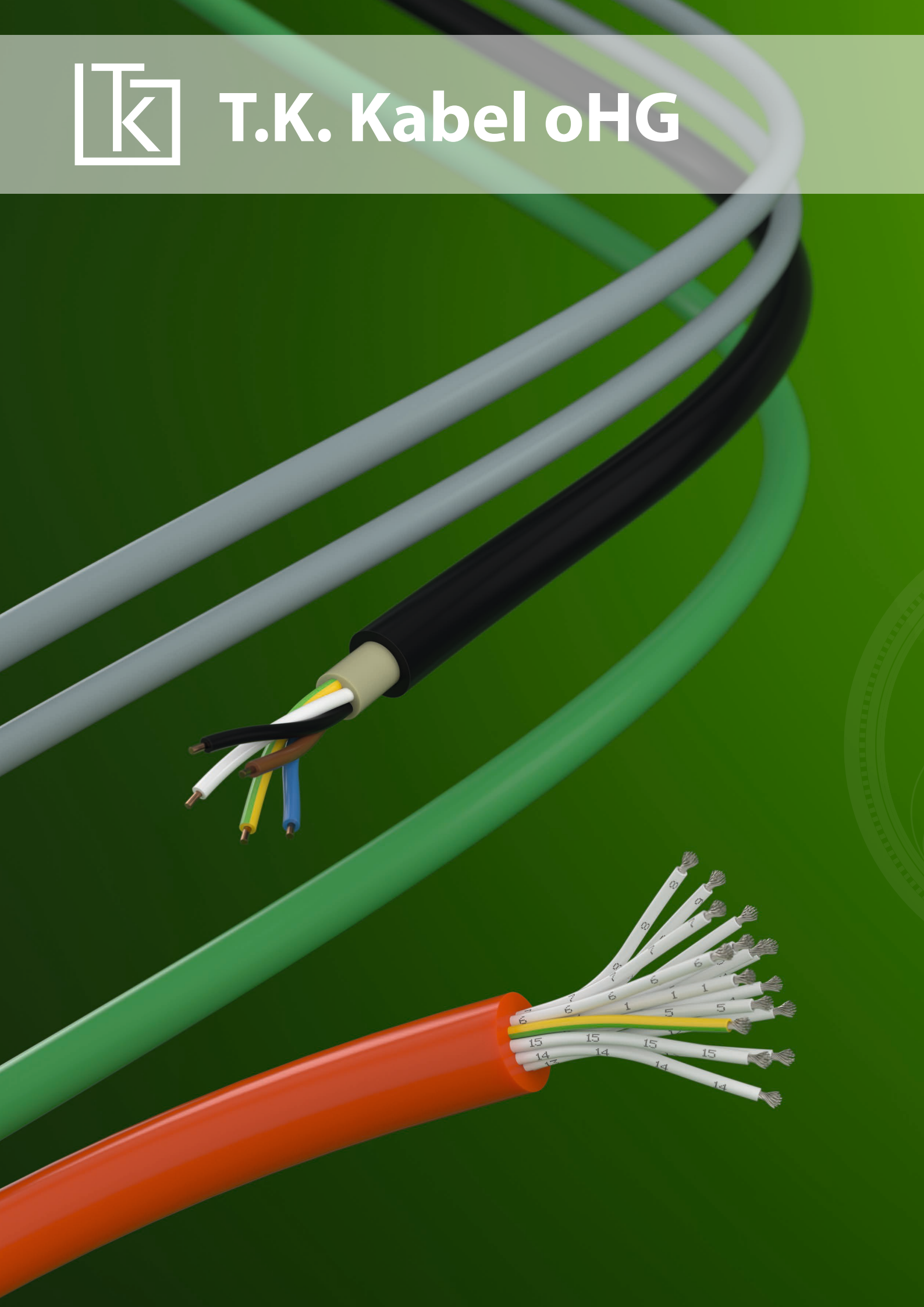

Insulated wires

H05V-U/-K
H07V-U/-K

160
161

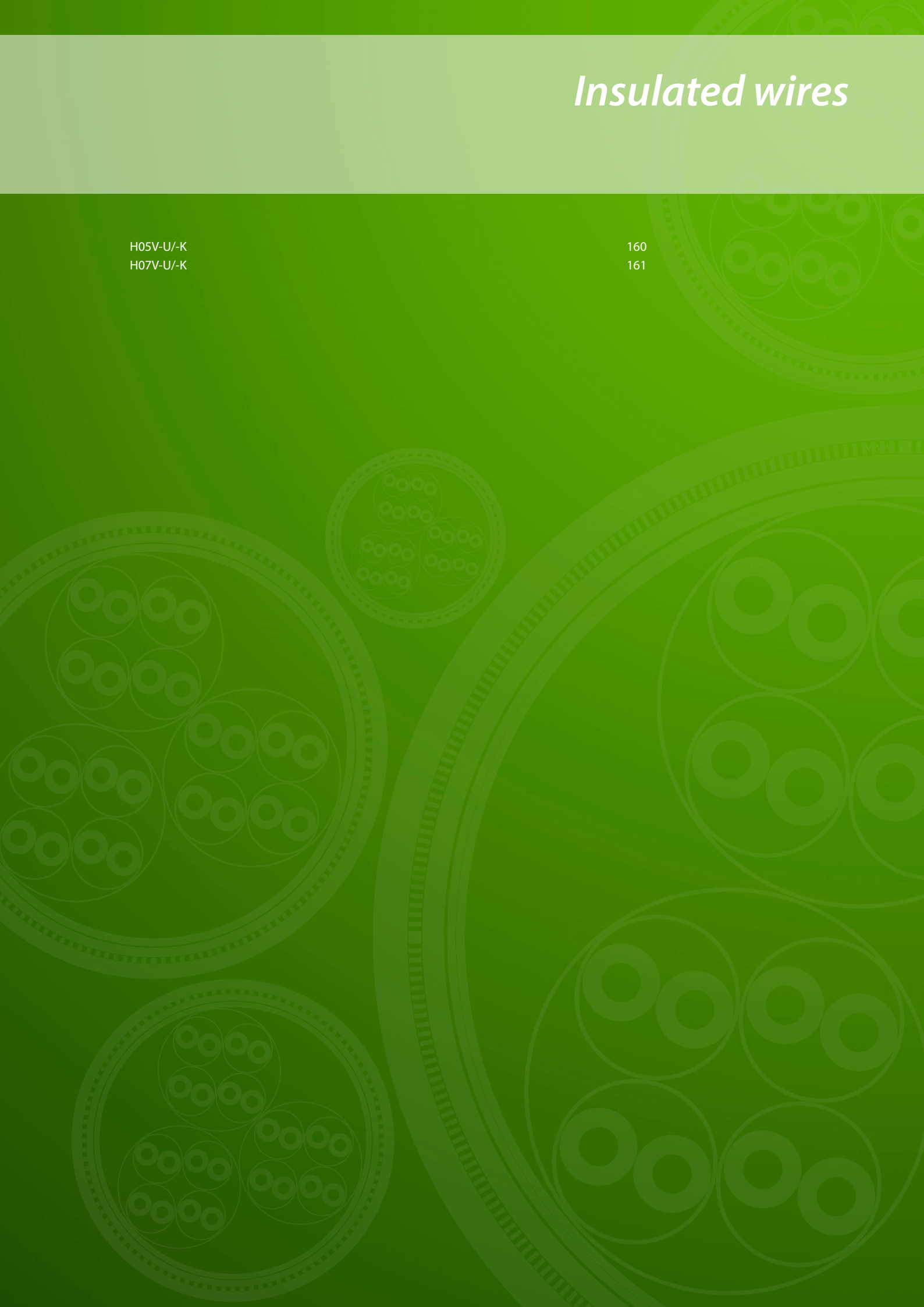

H05V-U/-K

solid (U) · fine stranded (K)
acc. VDE 0281 Part 3 / HD 21.3 S3

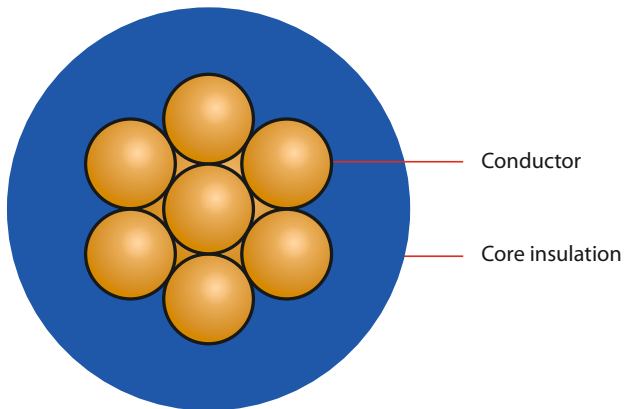

APPLICATION

These cables are intended for internal appliance wiring, as well as for protected laying in and on luminaires. Laying in conduits, on and under plaster for signalling equipment.

CONSTRUCTION

Conductor: copper solid, bare (U); copper, fine stranded (K) class 5
acc. VDE 0295

Core insulation: PVC

Core identification: acc. to VDE 0293

ELECTRICAL CHARACTERISTICS

Nominal voltage U_0 / U 300 / 500 V
Test voltage 2000 V

THERMAL & MECHANICAL PROPERTIES

Temperature during installation +5°C to +70°C
Temperature stationary -40°C to +70°C
Bending radius during installation min. 4 x diameter

Dimension	Sheath thickness approx. mm	Diameter approx. mm	Cable weight approx. kg/km	Copper index kg/km
H05V-U				
0.5	0.6	2.0	8.8	4.8
0.75	0.6	2.2	11.6	7.2
1.0	0.6	2.4	14.3	9.6
H05V-K				
0.5	0.6	2.2	8.7	4.8
0.75	0.6	2.3	11.1	7.2
1.0	0.6	2.5	13.8	9.6

Subject to changes due to technical progress and error



T.K. Kabel oHG · Geschwister-Scholl-Straße 11 · 71384 Weinstadt

Phone +49 (0) 7151/60 68 70 · Fax +49 (0) 7151/60 91 00 · info@tk-kabel.de · www.tk-kabel.de

H07V-U/-K

solid (U) · fine stranded (K)
acc. VDE 0281 Part 3 / HD 21.3 S3

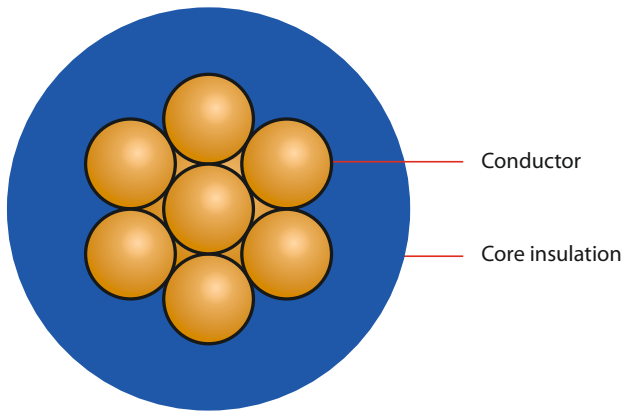

APPLICATION

These cables are intended for laying in conduits on, in and under plaster, as well as in closed installation ducts. They are also for use as potential equalisation cables directly on, in and under plaster. For internal wiring of appliances, switchgears and distributors as well as for protected laying in and on luminaires with nominal AC voltage up to 1000 V or DC voltage up to 750 V to ground. Operating DC voltage is permitted up to 900 V to ground when used in rail vehicles.

CONSTRUCTION

Conductor: copper solid, bare (U); copper, fine stranded (K);

acc. to VDE 0295 class 5

Core insulation: PVC

Core identification: acc. to VDE 0293

ELECTRICAL CHARACTERISTICS

Nominal voltage U_0 / U 450/750 V

Test voltage 2500 V

THERMAL & MECHANICAL PROPERTIES

Temperature during installation 5°C to +70°C

Temperature stationary -40°C to +70°C

Bending radius stationary min. 4 x diameter

Dimension	Sheath thickness approx. mm	Diameter approx. mm	Cable weight approx. kg/km	Copper index kg/km
H07V-U				
1.5	0.7	2.8	20.1	14.4
2.5	0.8	3.4	31.0	24
4	0.8	3.9	46.6	38
6	0.8	4.3	65.8	58
10	1.0	5.6	109.0	96
H07V-K				
1.5	0.7	3.0	19.3	14.4
2.5	0.8	3.6	30.4	24
4	0.8	4.2	45.6	38
6	0.8	4.7	63.2	58
10	1.0	6.2	110.8	96
16	1.0	7.1	163.4	154
25	1.2	8.7	252.9	240
35	1.2	10.1	345.6	336
50	1.4	12.1	490.6	480
70	1.4	14.3	677.3	672
95	1.6	16.2	889.6	912
120	1.6	17.8	1122.4	1152
150	1.8	21.0	1446.8	1440
185	2.0	22.5	1720.5	1776
240	2.2	25.0	2181.7	2304

Subject to changes due to technical progress and error





T.K. Kabel oHG

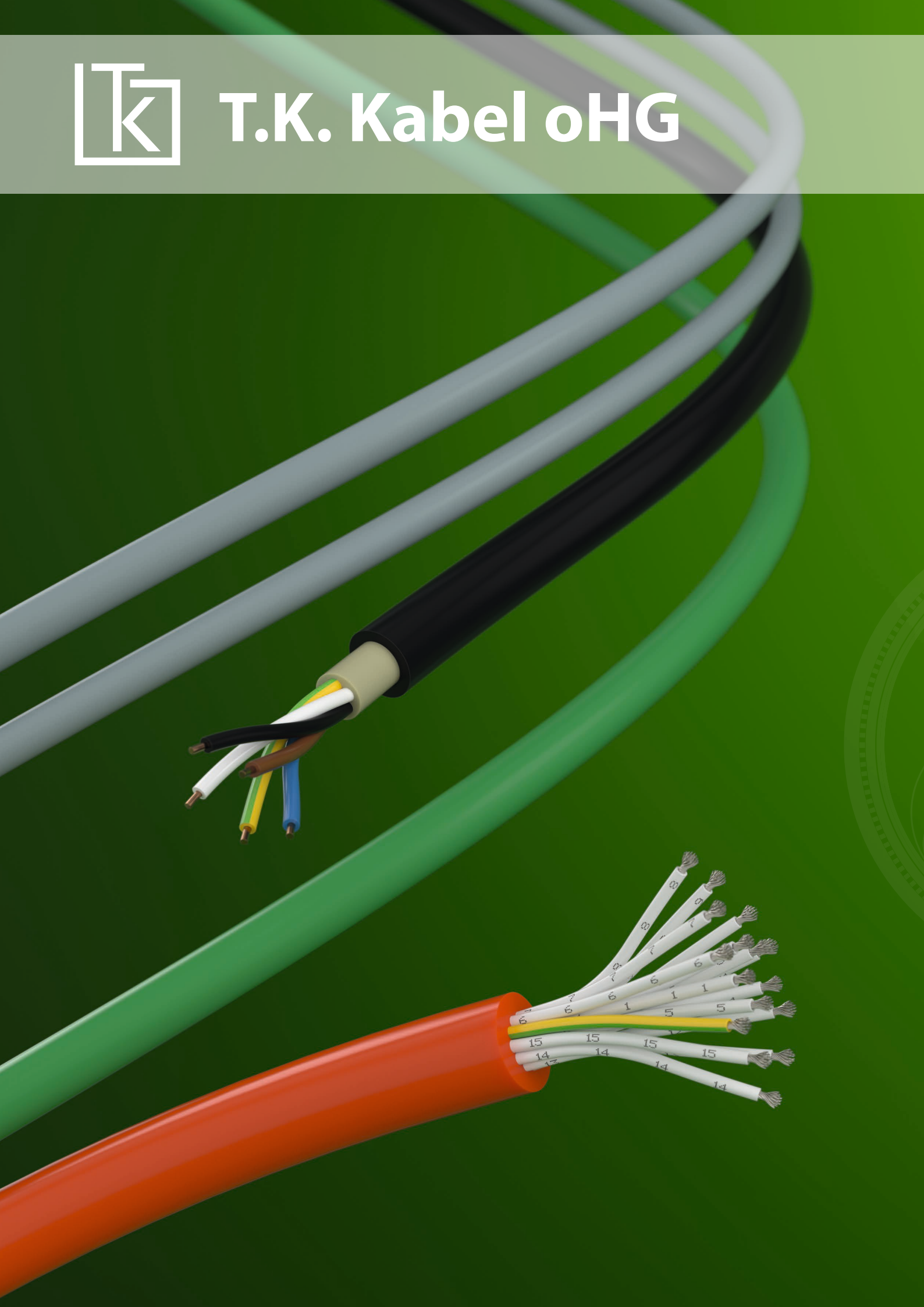

Data cables

SLAN 1000 S/FTP 4PR AWG 23/1
XLAN 1000 S/FTP 4PR AWG 23/1
XLAN 1200 S/FTP 4PR AWG 22/1
XLAN 1500 S/FTP 4PR AWG 22/1
XLAN flex 1000S/FTP 4PR AWG 26/7
XLAN flex 600 S/FTP 4PR AWG 26/7

164
165
166
167
168
169

SLAN 1000 S/FTP 4PR AWG 23/1

Category 7a · 1000 MHz

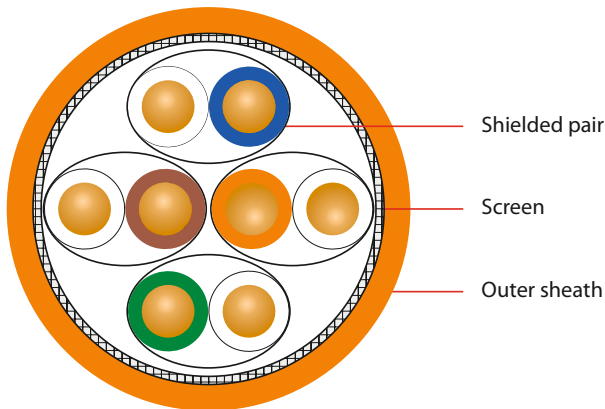

APPLICATION

Data cable for analogue and digital signal transmission in the frequency range up to 1000 MHz. It is designed for primary (campus), secondary (riser) and tertiary (horizontal) wiring.

Use: IEEE 802.3; 10/100/1000/10GBase-T; FDDI, broadband, video, ISDN, ATM, Multimedia, PoE

NORMEN

EN 50288-4-1; IEC 61156-5; EN 50173-1; ISO/IEC 11801 2nd edition; IEC 60332-1; IEC 60332-3-22; IEC 60754-2; EN 61034; IEC 61034 RoHS 2002/95/EC

CONSTRUCTION

Conductor: copper, solid, bare, AWG 23/1

Core insulation: SFS-PE

Core identification: wh-bu, wh-or, wh-gn, wh-bn

Core stranding: cores twisted to layers

Shielded pairs: each pair one layer plastic laminated aluminium foil; drain wire optional

Screen: tinned copper wire braid

Sheath: PVC or halogen-free compound (FRNC); colour: orange RAL 2003

ELECTRICAL CHARACTERISTICS

(Conductor) loop resistance max.	14.5 Ω/100 m
Insulation resistance min.	5 GΩ x km
Char. impedance 1 – 100 MHz	100 ±15 Ω
Char. impedance 100 – 250 MHz	100 ±22 Ω
Char. impedance 250 – 1000 MHz	100 ±25 Ω
Transfer impedance max. (10 MHz)	8 mΩ / m
Mutual capacitance nom.	45 nF/km
Relative propagation velocity approx.	0.78 c
Screen attenuation ≤ 1000 MHz	min. 75 dB
Test voltage	700 V-AC

Dimension	Sheath thickness approx. mm	Diameter approx. mm	Cable weight approx. kg/km	Copper index kg/km	Calorific potential MJ/km
4 x 2 x AWG23	0.60	7.6	60	26.3	610

Transmission characteristics

The stated performance data are characteristic measurements.

f MHz	Attenuation nom. dB/100m	NEXT nom. dB	ACR nom. dB/100m	EL-FEXT nom. dB/100m	RL nom. dB
1	1.8	105	103	95	25
4	3.3	105	102	93	28
10	5.3	105	100	92	30
16	6.7	105	98	91	32
20	7.5	105	97	90	34
31.25	9.6	105	95	86	35
62.5	13.8	103	89	82	34
100	17.3	100	83	77	33
155	22.6	98	75	73	30
200	24.8	95	70	70	29
300	30.7	93	62	67	27
400	35.8	90	54	64	26
500	39.7	87	47	62	24
600	44.2	85	41	60	23
800	50.8	83	32	56	22
900	56	81	25	53	21
1000	59	80	21	50	20

THERMAL & MECHANICAL PROPERTIES

Temperature range during installation	0° C to +50 °C
Temperature range stationary	-20 °C to +60 °C
Min. bending radius under tensile load	8 x diameter
Min. bending radius without tensile load	4 x diameter
Maximum traction	105 N

Subject to changes due to technical progress and error



T.K. Kabel oHG · Geschwister-Scholl-Straße 11 · 71384 Weinstadt

Phone +49 (0) 7151/60 68 70 · Fax +49 (0) 7151/60 91 00 · info@tk-kabel.de · www.tk-kabel.de

XLAN 1000 S/FTP 4PR AWG 23/1

Category 7a · 1000 MHz

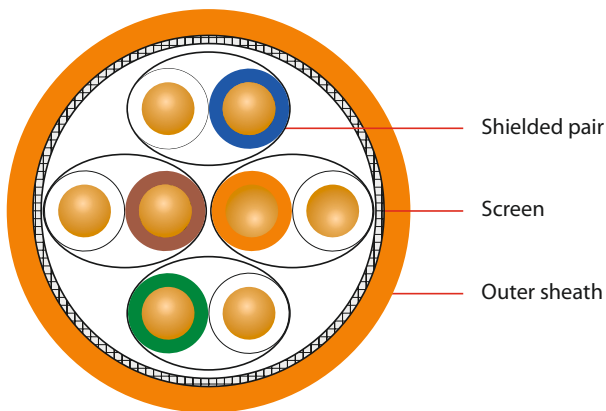

APPLICATION

Data cable for analogue and digital signal transmission in the frequency range up to 1000 MHz. It is designed for primary (campus), secondary (riser) and tertiary (horizontal) wiring.

Use: IEEE 802.3; 10/100/1000/10GBase-T; FDDI, broadband, video, ISDN, ATM, Multimedia, PoE

NORMEN

EN 50288-4-1; IEC 61156-5; EN 50173-1; ISO/IEC 11801 2nd edition; IEC 60332-1; IEC 60332-3-22; IEC 60754-2; EN 61034; IEC 61034 RoHS 2002/95/EC

CONSTRUCTION

Conductor: copper, solid, bare, AWG 23/1

Core insulation: SFS-PE

Core identification: wh-bu, wh-or, wh-gn, wh-bn

Core stranding: cores twisted to layers

Shielded pairs: each pair one layer plastic laminated aluminium foil; drain wire optional

Screen: tinned copper wire braid

Sheath: PVC or halogen-free compound (FRNC); colour: orange RAL 2003

ELECTRICAL CHARACTERISTICS

(Conductor) loop resistance max.	14.5 Ω/100 m
Insulation resistance min.	5 GΩ x km
Char. impedance 1 – 100 MHz	100 ±15 Ω
Char. impedance 100 – 250 MHz	100 ±22 Ω
Char. impedance 250 – 1000 MHz	100 ±25 Ω
Transfer impedance max. (10 MHz)	3 mΩ / m
Mutual capacitance nom.	45 nF/km
Relative propagation velocity approx.	0.78 c
Screen attenuation ≤ 1000 MHz min.	85 dB
Test voltage	700 V-AC

Dimension	Sheath thickness approx. mm	Diameter approx. mm	Cable weight approx. kg/km	Copper index kg/km	Calorific potential MJ/km
4 x 2 x AWG23	0.60	7.6	64	34	610

Transmission characteristics

The stated performance data are characteristic measurements.

f MHz	Attenuation nom. dB/100m	NEXT nom. dB	ACR nom. dB/100m	EL-FEXT nom. dB/100m	RL nom. dB
1	1.7	105	103	95	25
4	3.2	105	102	93	28
10	5.2	105	100	92	30
16	6.5	105	98	91	32
20	7.3	105	98	90	34
31.25	9.4	105	96	86	35
62.5	13.6	103	89	82	34
100	17	100	83	77	33
155	22.2	98	76	73	30
200	24.3	95	71	70	29
300	30.2	93	73	67	27
400	35.2	90	55	64	26
500	39.1	87	48	62	24
600	43.5	85	41	60	23
800	50	83	33	56	22
900	55.2	81	26	53	21
1000	58.1	80	22	50	20

THERMAL & MECHANICAL PROPERTIES

Temperature range during installation	0° C to +50 °C
Temperature range stationary	-20 °C to +60 °C
Min. bending radius under tensile load	8 x diameter
Min. bending radius without tensile load	4 x diameter
Maximum traction	105 N

Subject to changes due to technical progress and error



XLAN 1200 S/FTP 4PR AWG 22/1

Category 7a · 1200 MHz

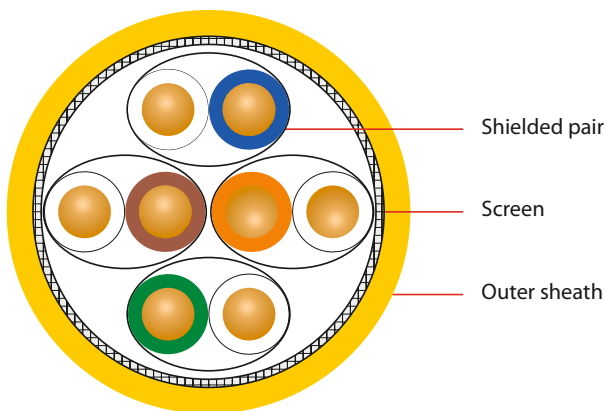

APPLICATION

Data cable for analogue and digital signal transmission in the frequency range up to 1200 MHz. It is designed for primary (campus), secondary (riser) and tertiary (horizontal) wiring.

Use: IEEE 802.3; 10/100/1000/10GBase-T; FDDI, broadband, video, ISDN, ATM, Multimedia, PoE

NORMEN

EN 50288-4-1; IEC 61156-5; EN 50173-1; ISO/IEC 11801 2nd edition; IEC 60332-1; IEC 60332-3-22; IEC 60754-2; EN 61034; IEC 61034 RoHS 2002/95/EC

CONSTRUCTION

Conductor: copper, solid, bare, AWG 22/1

Core insulation: SFS-PE

Core identification: wh-bu, wh-or, wh-gn, wh-bn

Core stranding: cores twisted to layers

Shielded pairs: each pair one layer plastic laminated aluminium foil; drain wire optional

Screen: tinned copper wire braid

Sheath: PVC or halogen-free compound (FRNC); colour: yellow RAL 1021

ELECTRICAL CHARACTERISTICS

(Conductor) loop resistance max.	13.0 Ω/100 m
Insulation resistance min.	5 GΩ x km
Char. impedance 1 – 100 MHz	100 ±15 Ω
Char. impedance 100 – 250 MHz	100 ±22 Ω
Char. impedance 250 – 1000 MHz	100 ±25 Ω
Transfer impedance max. (10 MHz)	5 mΩ / m
Mutual capacitance nom.	45 nF/km
Relative propagation velocity approx.	0.79 c
Screen attenuation ≤ 1000 MHz min.	85 dB
Test voltage	700 V-AC

Dimension	Sheath thickness approx. mm	Diameter approx. mm	Cable weight approx. kg/km	Copper index kg/km	Calorific potential MJ/km
4 x 2 x AWG22	0.60	7.9	73	42	705

Transmission characteristics

The stated performance data are characteristic measurements.

f MHz	Attenuation nom. dB/100m	NEXT nom. dB	ACR nom. dB/100m	EL-FEXT nom. dB/100m	RL nom. dB
1	1.7	105	103	105	25
4	3.2	105	102	103	28
10	5.1	105	100	100	30
16	6.4	105	99	98	30
20	7.1	105	98	95	30
31.25	9	105	96	93	30
62.5	13.1	105	92	90	30
100	16.5	102	85	85	30
155	21.6	100	78	82	29
200	23.5	98	74	78	28
300	29.1	96	67	70	27
500	37	91	54	63	26
600	41.5	88	46	60	25
1000	55.9	78	32	52	21
1200	60.8	76	15	42	19

THERMAL & MECHANICAL PROPERTIES

Temperature range during installation	0° C to +50 °C
Temperature range stationary	-20 °C to +60 °C
Min. bending radius under tensile load	8 x diameter
Min. bending radius without tensile load	4 x diameter
Maximum traction	130 N

Subject to changes due to technical progress and error



XLAN 1500 S/FTP 4PR AWG 22/1

Category 7a · 1500 MHz

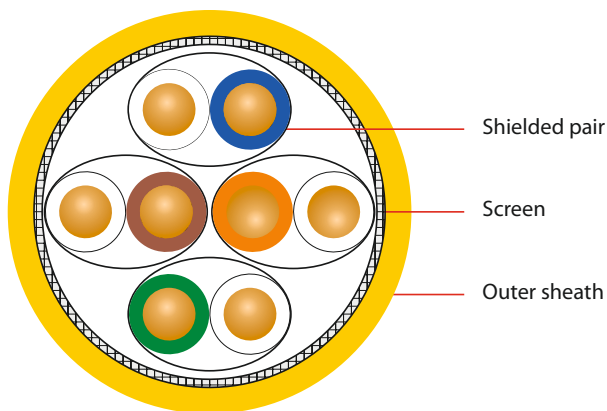

APPLICATION

Data cable for analogue and digital signal transmission in the frequency range up to 1500 MHz. It is designed for primary (campus), secondary (riser) and tertiary (horizontal) wiring.

Use: IEEE 802.3; 10/100/1000/10GBase-T; FDDI, broadband, video, ISDN, ATM, Multimedia, PoE

NORMEN

EN 50288-4-1; IEC 61156-5; EN 50173-1; ISO/IEC 11801 2nd edition; IEC 60332-1; IEC 60332-3-22; IEC 60754-2; EN 61034; IEC 61034 RoHS 2002/95/EC

CONSTRUCTION

Conductor: copper, solid, bare, AWG 22/1

Core insulation: SFS-PE

Core identification: wh-bu, wh-or, wh-gn, wh-bn

Core stranding: cores twisted to layers

Shielded pairs: each pair one layer plastic laminated aluminium foil; drain wire optional

Screen: tinned copper wire braid

Sheath: PVC or halogen-free compound (FRNC); colour: yellow RAL 1021

ELECTRICAL CHARACTERISTICS

(Conductor) loop resistance max.	11.5 Ω/100 m
Insulation resistance min.	5 GΩ x km
Char. impedance 1 – 100 MHz	100 ±15 Ω
Char. impedance 100 – 250 MHz	100 ±22 Ω
Char. impedance 250 – 1000 MHz	100 ±25 Ω
Transfer impedance max. (10 MHz)	5 mΩ / m
Mutual capacitance nom.	45 nF/km
Relative propagation velocity approx.	0,79 c
Screen attenuation ≤ 1000 MHz min.	85 dB
Test voltage	700 V-AC

Dimension	Sheath thickness approx. mm	Diameter approx. mm	Cable weight approx. kg/km	Copper index kg/km	Calorific potential MJ/km
4 x 2 x AWG22	0.60	8.4	73	42	705

Transmission characteristics

The stated performance data are characteristic measurements.

f MHz	Attenuation nom. dB/100m	NEXT nom. dB	ACR nom. dB/100m	EL-FEXT nom. dB/100m	RL nom. dB
1	1.7	105	103	105	25
4	3.2	105	102	103	28
10	5	105	100	100	30
16	6.3	105	99	98	30
20	7	105	98	95	30
31.25	8.9	105	96	93	30
62.5	13	105	92	90	30
100	16.2	102	86	85	30
155	21.2	100	79	82	29
200	23	98	75	78	28
300	28.5	96	67	70	27
500	36.2	91	55	63	26
600	40.7	88	47	60	25
1000	55	78	23	52	21
1200	59.7	76	16	42	19
1300	61	74	13	40	18
1400	62.8	73	10	35	17
1500	64.5	72	8	30	14

THERMAL & MECHANICAL PROPERTIES

Temperature range during installation	0° C to +50 °C
Temperature range stationary	-20 °C to +60 °C
Min. bending radius under tensile load	8 x diameter
Min. bending radius without tensile load	4 x diameter
Maximum traction	150 N

Subject to changes due to technical progress and error



XLAN flex 1000 S/FTP 4PR AWG 26/7

Patch cable
Category 7 · Class F · flexible cables · 1000 MHz

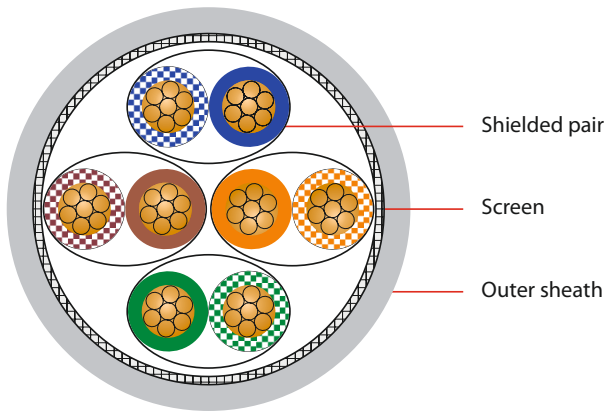

APPLICATION

Flexible data cable for analogue and digital signal transmission in the frequency range up to 1000 MHz. It is designed for wiring in workplace areas for appliance connection or as switchboard cable in patch panels.

Use: IEEE 802.3: 10/100/1000/10GBase-T; IEEE 802.5: FDDI, ISDN, ATM

STANDARDS

ISO/IEC 11801, 2nd edition, EN 50173-1; IEC 61156-5; EN 50288-4-2 IEC 60332-1; IEC 60754-2; EN 61034; IEC 61034; RoHS 2002/95/EC

CONSTRUCTION

Conductor: copper, strand, tinned, AWG 26/7

Core insulation: SFS-PE

Core identification: whbu-bu, whor-or, whgn-gn, whbn-bn

Core stranding: cores twisted to layers

Shielded pairs: each pair one layer plastic laminated aluminium foil; drain wire optional

Screen: tinned copper wire braid

Sheath: halogen-free compound (FRNC);

colour: grey RAL 7035 or acc. to customer request

ELECTRICAL CHARACTERISTICS

(Conductor) loop resistance max.	290 Ω/100 km
Insulation resistance min.	2 GΩ x km
Char. impedance 1 – 100 MHz	100 ±15 Ω
Char. impedance 100 – 250 MHz	100 ±22 Ω
Char. impedance 250 – 1000 MHz	100 ±25 Ω
Transfer impedance max. (10 MHz)	10 mΩ / m
Mutual capacitance nom.	45 nF/km
Relative propagation velocity approx.	0.77 c
Screen attenuation ≤ 1000 MHz min.	60 dB
Test voltage	700 V-AC

Dimension	Sheath thickness approx. mm	Diameter approx. mm	Cable weight approx. kg/km	Copper index kg/km	Calorific potential MJ/km
4 x 2 x AWG26/7	0.50	6.1	41	22	350

Transmission characteristics

The stated performance data are characteristic measurements.

f MHz	Attenuation nom. dB/100m	NEXT nom. dB	ACR nom. dB/100m	EL-FEXT nom. dB/100m	RL nom. dB
1	0.28	100	100	99	25
4	0.55	100	100	97	29
10	0.85	100	99	95	33
16	1.05	100	99	93	33
20	1.2	100	99	90	33
31,25	1.5	100	98	85	33
62,5	2.1	100	98	76	31
100	2.7	98	95	72	30
200	3.85	94	90	67	28
300	4.7	90	85	60	27
500	5.7	84	78	58	26
600	6.75	82	75	55	25
800	7.9	78	70	52	24
900	8.4	77	69	50	23
1000	9.2	76	67	45	22

THERMAL & MECHANICAL PROPERTIES

Temperature range during installation	0° C to +50 °C
Temperature range stationary	-20 °C to +60 °C
Min. bending radius under tensile load	8 x diameter
Min. bending radius without tensile load	4 x diameter
Maximum traction	80 N

Subject to changes due to technical progress and error



XLAN flex 600 S/FTP 4PR AWG 26/7

Patch cable
Category 7 · Class F · flexible cables · 600 MHz

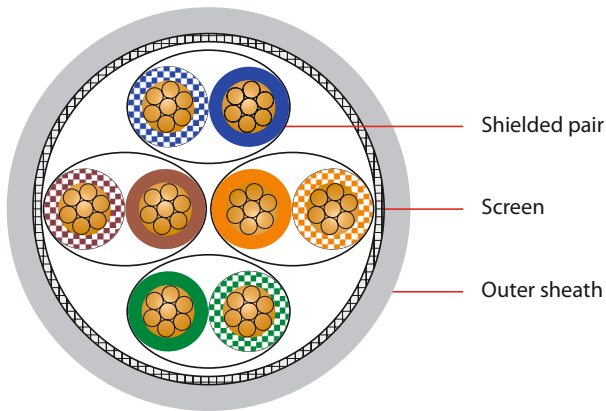

APPLICATION

Flexible data cable for analogue and digital signal transmission in the frequency range up to 600 MHz. It is designed for wiring in workplace areas for appliance connection or as switchboard cable in patch panels.

Use: IEEE 802.3; 10/100/1000/10GBase-T; IEEE 802.5: FDDI, ISDN, ATM

STANDARDS

ISO/IEC 11801, 2nd edition, EN 50173-1; IEC 61156-5; EN 50288-4-2
IEC 60332-1; IEC 60754-2; EN 61034; IEC 61034; RoHS 2002/95/EC

CONSTRUCTION

Conductor: copper, strand, tinned, AWG 26/7

Core insulation: SFS-PE

Core identification: whbu-bu, whor-or, whgn-gn, whbn-bn

Core stranding: cores twisted to layers

Shielded pairs: each pair one layer plastic laminated aluminium foil; drain wire optional

Screen: tinned copper wire braid

Sheath: halogen-free compound (FRNC);

colour: grey RAL 7035 or acc. to customer request

ELECTRICAL CHARACTERISTICS

(Conductor) loop resistance max.	290 Ω/100 km
Insulation resistance min.	2 GΩ x km
Char. impedance 1 – 100 MHz	100 ±15 Ω
Char. impedance 100 – 250 MHz	100 ±22 Ω
Char. impedance 250 – 1000 MHz	100 ±25 Ω
Transfer impedance max. (10 MHz)	10 mΩ / m
Mutual capacitance nom.	45 nF/km
Relative propagation velocity approx.	0.76 c
Screen attenuation ≤ 1000 MHz min.	60 dB
Test voltage	700 V-AC

Dimension	Sheath thickness approx. mm	Diameter approx. mm	Cable weight approx. kg/km	Copper index kg/km	Calorific potential MJ/km
4 x 2 x AWG26/7	0.50	6.1	41	22	350

Transmission characteristics

The stated performance data are characteristic measurements.

f MHz	Attenuation nom. dB/100m	NEXT nom. dB	ACR nom. dB/100m	EL-FEXT nom. dB/100m	RL nom. dB
1	0.28	100	100	99	25
4	0.55	100	100	97	29
10	0.85	100	99	95	33
16	1.05	100	99	93	33
20	1.20	100	99	90	33
31.25	1.50	100	98	85	33
62.5	2.10	100	98	76	31
100	2.70	98	95	72	30
200	3.85	94	90	67	28
300	4.70	90	85	60	27
500	5.70	84	78	58	26
600	6.75	82	75	55	25

THERMAL & MECHANICAL PROPERTIES

Temperature range during installation	0° C to +50 °C
Temperature range stationary	-20 °C to +60 °C
Min. bending radius under tensile load	8 x diameter
Min. bending radius without tensile load	4 x diameter
Maximum traction	80 N

Subject to changes due to technical progress and error





T.K. Kabel oHG

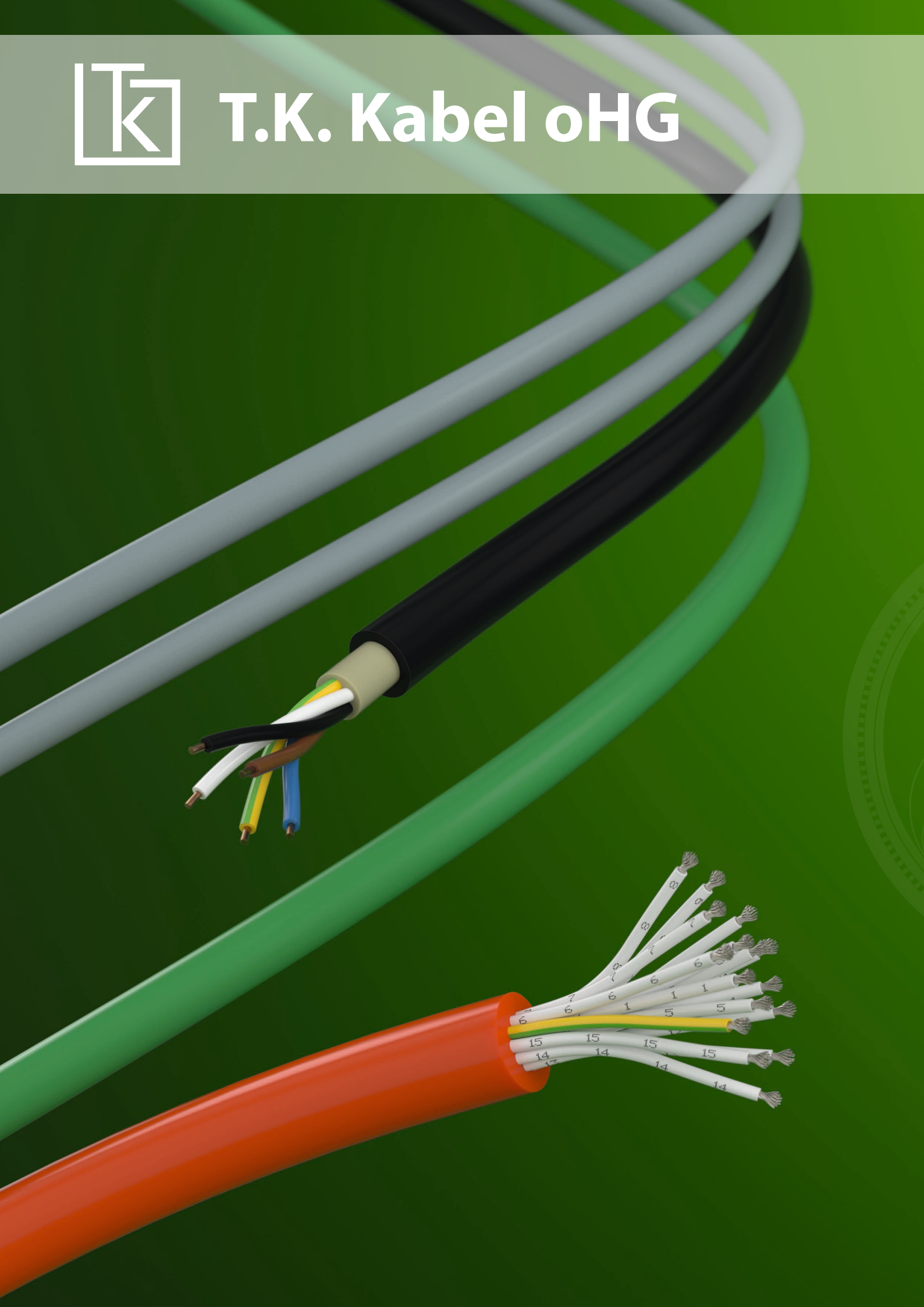

Technical Information

Core identification according to vde 0815	172	LAN - Key cable parameters	182
Core identification according to din 47100	173	Codes	184
Core identification according to din vde 0293	174	KTG - cable drums	186
Colour codes	174	Non-returnable drums	188
Strand construction & conductor resistance acc. vde 0295	175	Properties and test specifications	190
Strand conversion AWG	176	CE-Identification	192
Basic material properties	177	General	193
Intern. ident. colours for temp. measurement technology	178	Environment protection	193
LAN - Fire behaviour, fire propagation and calorific potential	179	General Terms and Conditions	194
LAN - Planning and installation advice	180	Environment protection	201
LAN - Planning and installation advice	181	General Terms and Conditions	202
LAN - Instructions for connection	181		

CORE IDENTIFICATION ACCORDING TO VDE 0815

Installation cables

JE-Y(ST)Y	JE-Y(ST)Yv	JE-Y(ST)YY	JE-YCY	RD-Y(ST)Y
JE-LIYCY	JE-LIYY	JE-LIY(ST)Y		
JE-LIHCH	JE-LIHH	JE-H(ST)H	JE-HCH	

PAIR

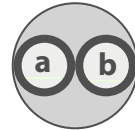

Basic colours of insulating covers in installation cables with 2 pairs as star quads								
Circuit	1		2					
Core	a	b	a	b				
Basic colour	blue	red	grey	yellow				

PAIRS FORMED TO UNITS

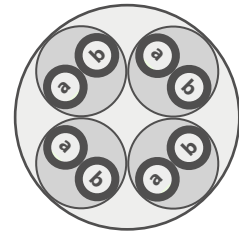

Basic colours of insulating covers of unit pairs								
Circuit	1		2		3		4	
Core	a	b	a	b	a	b	a	b
Basic colour	blue	red	grey	yellow	green	brown	white	black

To distinguish individual units, cores must be identified by smear-resistant coloured rings, or units by spirals of plastic tape with printed unit number.

When applying the ring identification to distinguish the units, the coloured cores must be identified according to table 2 above and picture 1 on the right. The dimensions in picture 1 should be observed to ensure clear distinction of the units. A slight blurring at the edge of the ring identification and a minor misalignment of the 2 semirings are permitted.

IDENTIFICATION BY RINGS

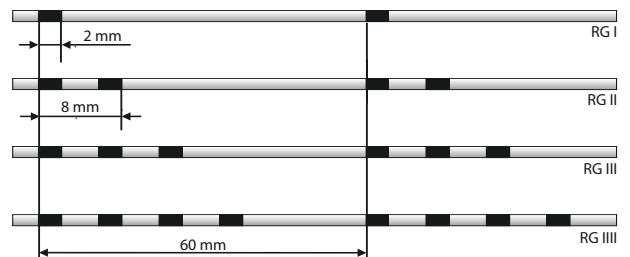

IDENTIFICATION OF UNITS BY RING GROUPS

Unit no.	Ring colour	Ring group		Spiral colour
		Units of 4 cores	Units of 8 cores/ 4 pairs	
1	pink	I	I	
2		I	II	
3		II	III	
4		II	IIII	
5	orange		I	
6			II	
7			III	
8			IIII	
9	violet		I	
10			II	
11			III	
12			IIII	

Unit no.	Ring colour	Ring group		Spiral colour
		units of 4 cores	Units of 8 cores/ 4 pairs	
13	pink		I	blue
14			II	
15			III	
16			IIII	
17	orange		I	red
18			II	
19			III	
20			IIII	

In cables with more than 12 units, additional units are identified by a coloured plastic spiral. The counting of units starts with the inner layer and continues in the same direction throughout all layers to the outside.



CORE IDENTIFICATION ACCORDING TO DIN 47100

Electronic control cables and computer cables

LIYY and LIYCY

The first colour is the basic core colour.

If cores are multi-coloured, identification is composed of one basic colour and one contemporary colour.

Counting from the outside to the inside continuing throughout all layers.

CORE STRANDING

(cables with 4 cores are stranded in the colour order white, yellow, brown, green)

Core	Colour	Core	Colour	Core	Colour	Core	Colour	Core	Colour
1	white	19	whitegrey	37	greyblue	55	greypink	73	pinkgreen
2	brown	21	pinkbrown	38	pinkblue	56	redblue	74	yellowpink
3	green	21	whiteblue	39	greyred	57	whitegreen	75	pinkgreen
4	yellow	22	brownblue	40	pinkred	58	browngreen	76	yellowblue
5	grey	23	whitered	41	greyblack	59	whiteyellow	77	greenred
6	pink	24	brownred	42	pinkblack	60	yellowbrown	78	yellowred
7	blue	25	whiteblack	43	blueblack	61	whitegrey	79	greenblack
8	red	26	brownblack	44	redblack	62	greybrown	80	yellowblack
9	black	27	greygreen	45	white	63	whitepink	81	greyblue
10	violet	28	yellowgrey	46	brown	64	pinkbrown	82	pinkblue
11	greypink	29	pinkgreen	47	green	65	whiteblue	83	greyred
12	redblue	30	yellowpink	48	yellow	66	brownblue	84	pinkred
13	whitegreen	31	greenblue	49	grey	67	whitered	85	greyblack
14	browngreen	32	yellowblue	50	pink	68	brownred	86	pinkblack
15	whiteyellow	33	greenred	51	blue	69	whiteblack	87	blueblack
16	yellowbrown	34	yellowred	52	red	70	brownblack	88	redblack
17	whitegrey	35	greenblack	53	black	71	greygreen		
18	yellowbrown	36	yellowblack	54	violet	72	yellowgrey		

PAIRED STRANDING

Pair	Core	Colour	Pair	Core	Colour	Pair	Core	Colour	Pair	Core	Colour		
1	45	a b	white brown	12	56	a b	whitered brownred	23	a b	white brown	34	a b	whitered brownred
2	46	a b	green yellow	13	57	a b	whiteblack brownblack	24	a b	green yellow	35	a b	whiteblack brownblack
3	47	a b	grey pink	14	58	a b	greygreen yellowgrey	25	a b	grey pink	36	a b	greygreen yellowgrey
4	48	a b	blue red	15	59	a b	pinkgreen yellowpink	26	a b	blue red	37	a b	pinkgreen yellowpink
5	49	a b	black violet	16	60	a b	greenblue yellowblue	27	a b	black violet	38	a b	pinkgreen yellowblue
6	50	a b	greypink redblue	17	61	a b	greenred yellowred	28	a b	greypink redblue	39	a b	greenred yellowred
7	51	a b	whitegreen browngreen	18	62	a b	greenblack yellowblack	29	a b	whitegreen browngreen	40	a b	greenblack yellowblack
8	52	a b	whiteyellow yellowbrown	19	63	a b	greyblue pinkblue	30	a b	whiteyellow yellowbrown	41	a b	greyblue pinkblue
9	53	a b	whitegrey greybrown	20	64	a b	greyred pinkred	31	a b	whitegrey greybrown	42	a b	greyred pinkred
10	54	a b	whitepink pinkbrown	21	65	a b	greyblack pinkblack	32	a b	whitepink pinkbrown	43	a b	greyblack pinkblack
11	55	a b	whiteblue brownblue	22	66	a b	blueblack redblack	33	a b	whiteblue brownblue	44	a b	blueblack redblack



CORE IDENTIFICATION ACCORDING TO DIN VDE 0293

CORE IDENTIFICATION IN MULTICORE CABLES

Number of cores	Cables with green-yellow marked core (protection core) Code "J"					Cables without green-yellow marked core (protection core) Code "O"				
	Protection core	Active core				Active core				
2	-					blue	brown			
3	green-yellow	blue	brown			-	brown	black	grey	
4	green-yellow	-	brown	black	grey	blue	brown	black	grey	
5	green-yellow	blue	brown	black	grey	blue	brown	black	grey	black

COLOUR CODES

CODE COLOUR IDENTIFICATION

acc. to IEC 757 Colour	Code		RAL
	old	new	
black	sw	BK	9005
white	ws	WH	9010
blue	bl	BU	5015
red	rt	RD	3000
brown	bn	BN	8003
grey	gr	GY	7001
yellow	ge	YE	1021
green	gn	GN	6018
violet	vio	VT	4005
green-yellow	gnge	GNYE	6018/1021
orange	org	OG	2003
pink	rs	PK	3015
darkblue	dbl		5010
darkbrown	dbn		8014
transparent	tr		-
ultramarine blue	ubl		5002

COLOUR CODE FOR VEHICLE CABLES

Cores	Core colours
1	rd
2	wh, bk
3	wh, bk, bn
4	wh, bk, bn, ye
5	wh, bk, bn, ye, gn
6	wh, bk, bn, ye, gn, rd
7	wh, bk, bn, ye, gn, rd, bu
8	wh, bk, bn, ye, gn, rd, bu, vt

COLOUR CODE FOR YR-CABLES

Cores	Core colours
2 x 0.8	bk, bu
3 x 0.8	bk, bu, bn
4 x 0.8	bk, bu, bn, ye
5 x 0.8	bk, bu, bn, ye, gn
6 x 0.8	bk, bu, bn, ye, gn, vt
8 x 0.8	bk, bu, bn, ye, gn, vt, wh, og
10 x 0.8	bk, bu, bn, ye, gn, vt, wh, og, tr, gy
12 x 0.8	bk, bu, bn, ye, gn, vt, wh, og, tr, gy, rd, lbu
14 x 0.8	bk, bu, bn, ye, gn, vt, wh, og, tr, gy, rd, lbu, cog, lgn
16 x 0.8	bk, bu, bn, ye, gn, vt, wh, og, tr, gy, rd, lbu, cog, lgn, lrd, lye

COLOUR CODE FOR YYSCH-CABLES

Cores	Core colours
2 x 0.6	ye, bn
3 x 0.6	ye, gn, bn
4 x 0.6	ye, gn, bn, bk
5 x 0.6	ye, gn, bn, bk, bu
6 x 0.6	ye, gn, bn, gy, pk, wh
10 x 0.6	wh, bk, hbu, bn, gn, ye, gy, pk, bu, rd
16 x 0.6	1st layer: wh, bk, lbu, bn, gn 2nd layer: ye, lgy, pk, bu, rd, tr, gy, vt, lgn, og, elf
26 x 0.6	core: wh, bk + 2 drain wires 1st layer: lbu, bn, gn, ye, lgy, pk, bu, rd, tr 2nd layer: gy, vt, lgn, og, elf, whbu, whye, whgn, whbn, whbk, rdbu, rdye, rdgn, rdbn, rdbk



STRAND CONSTRUCTION & CONDUCTOR RESISTANCE ACC. VDE 0295

CONSTRUCTION OF STRANDED WIRES

	1	2	3	4	5	6	7
Cross-section	Stranded wires	Multi-stranded wires	Fine-stranded wires	Fine-stranded wires			
	VDE 0295		VDE 0295	VDE 0295			
mm ²	class 2		class 5	class 6			
0.14				18 x 0.10	18 x 0.10	36 x 0.07	72 x 0.05
0.25			14 x 0.16	32 x 0.10	32 x 0.10	65 x 0.07	128 x 0.05
0.34		7 x 0.25	19 x 0.16	42 x 0.10	42 x 0.10	88 x 0.07	174 x 0.05
0.38		7 x 0.27	12 x 0.21	21 x 0.16	48 x 0.10	100 x 0.07	194 x 0.05
0.5	7 x 0.30	7 x 0.30	16 x 0.21	28 x 0.16	64 x 0.10	131 x 0.07	256 x 0.05
0.75	7 x 0.37	7 x 0.37	24 x 0.21	42 x 0.16	96 x 0.10	195 x 0.07	384 x 0.05
1.0	7 x 0.43	7 x 0.43	32 x 0.21	56 x 0.16	128 x 0.10	260 x 0.07	512 x 0.05
1.5	7 x 0.52	7 x 0.52	30 x 0.26	84 x 0.16	192 x 0.10	392 x 0.07	768 x 0.05
2.5	7 x 0.67	19 x 0.41	50 x 0.26	140 x 0.16	320 x 0.10	651 x 0.07	1290 x 0.05
4	7 x 0.85	19 x 0.52	56 x 0.31	224 x 0.16	512 x 0.10	1040 x 0.07	
6	7 x 1.05	19 x 0.64	84 x 0.31	192 x 0.21	768 x 0.10	1560 x 0.07	
10	7 x 1.35	49 x 0.51	80 x 0.41	320 x 0.21	1280 x 0.10	2600 x 0.07	
16	7 x 1.70	49 x 0.65	128 x 0.41	512 x 0.21	2048 x 0.10		
25	7 x 2.13	84 x 0.62	200 x 0.41	800 x 0.21	3200 x 0.10		
35	7 x 2.52	133 x 0.58	280 x 0.41	1120 x 0.21			
50	19 x 1.83	133 x 0.69	400 x 0.41	705 x 0.31			
70	19 x 2.17	189 x 0.69	356 x 0.51	990 x 0.31			
95	19 x 2.52	259 x 0.69	485 x 0.51	1340 x 0.31			
120	37 x 2.03	336 x 0.67	614 x 0.51	1690 x 0.31			
150	37 x 2.27	392 x 0.69	765 x 0.51	2123 x 0.31			
185	37 x 2.52	494 x 0.69	944 x 0.51	170 x 0.41			
240	61 x 2.24	627 x 0.70	1225 x 0.51	1905 x 0.41			
300	61 x 2.50	790 x 0.70	1530 x 0.51	2385 x 0.41			
400	61 x 2.89		2035 x 0.51				
500	61 x 3.23		1768 x 0.61				

The number of wires in columns 3 to 7 is free from obligation.

The VDE 0295 only lays down the maximum diameter of the single wire and the maximum resistance which is related to the cross-section.

ELECTRIC RESISTANCE OF CONDUCTORS

Cross-section mm ²	Tinned wires		Bare wires		Cross section mm ²	Tinned wires		Bare wires	
	Class 1/2	Class 5/6	Class 1/2	Class 5/6		Class 1/2	Class 5/6	Class 1/2	Class 5/6
0.14		142		138	25	0.734	0.795	0.727	0.78
0.25		82		79	35	0.529	0.565	0.524	0.554
0.34		59		57	50	0.391	0.393	0.387	0.386
0.38		46		44	70	0.27	0.277	0.268	0.272
0.5	36.7	40.1	36	39	95	0.195	0.21	0.193	0.206
0.75	24.8	26.7	24	26	120	0.154	0.164	0.153	0.161
1.0	18.2	20	18.1	19.5	150	0.126	0.132	0.124	0.129
1.5	12.2	13.7	12.1	13.3	185	0.1	0.108	0.0991	0.106
2.5	7.56	8.21	7.41	7.98	240	0.0762	0.0817	0.0754	0.0801
4	4.7	5.09	4.61	4.95	300	0.0607	0.0654	0.0601	0.0641
6	3.11	3.39	3.08	3.3	400	0.0475	0.0495	0.047	0.0486
10	1.84	1.95	1.83	1.91	500	0.0369	0.0391	0.0366	0.0384
16	1.16	1.24	1.15	1.21					



STRAND CONVERSION AWG

AWG No.	Construction of strands acc. to AWG concentric	Construction of strands acc. to VDE bunched	Solid wire acc. to AWG or VDE mm	Conductor cross-section mm ²	Conductor resistance Ω/km	Copper index
28				0.08	216	0.80
28	7 x 0.127		0.321	0.09		0.89
28		10 x 0.10		0.08		0.79
28		10 x 0.12		0.11		1.13
VDE			0.40	0.13		1.26
26			0.405	0.13	130	1.28
26	7 x 0.160			0.14		1.41
26		18 x 0.10		0.14		1.41
VDE			0.50	0.20		1.96
24			0.511	0.21	87	2.05
24	7 x 0.203			0.23		2.27
24	19 x 0.127			0.24		2.41
24		11 x 0.16		0.22		2.21
24		14 x 0.15		0.25		2.47
23			0.574	0.259	66.5	2.30

AWG No.	Construction of strands acc. to AWG concentric	Construction of strands acc. to VDE bunched	Solid wire acc. to AWG or VDE mm	Conductor cross-section mm ²	Conductor resistance Ω/km	Copper index
VDE			0.60	0.28		2.83
22			0.644	0.33	53	3.25
22	7 x 0.254			0.35		3.55
22	19 x 0.160			0.38		3.82
22		7 x 0.25		0.34		3.44
20			0.812	0.52	33	5.03
20	7 x 0.320			0.56		5.63
20	19 x 0.203			0.61		6.15
20		7 x 0.32		0.56		5.63
18			1.024	0.82	20	8.23
18	7 x 0.404			0.90		8.97
18	19 x 0.254			0.96		9.63
18		19 x 0.26		1.00		10.09
16			1.290	1.31	13	13.07
16	7 x 0.510			1.43		14.30
16	19 x 0.320			1.53		15.28
16		30 x 0.25		1.47		14.73

Conversion AWG (28-16) into Metric Dim.: In US-American areas of influence and in the computer industry it is customary to define the dimensions of copper wires and strands in AWG(American Wire Gauge). The table shows bunched strands and wires acc. to VDE (regular typeface) in comparison with concentric AWG strands and AWG solid wires (boldface).

BASIC MATERIAL PROPERTIES

Material	Code	VDE	Temperature range (°C)	Tensile strength (N/mm ²)	Elongation (%)	Density (g/cm ³)	Volume resistance (Ω x cm)
Polyvinylchloride	PVC	Y	-30...+70	10...25	150...300	1.2...1.5	10 ¹² ...10 ¹⁵
Polyvinylchloride, heat resistant	PVC	Y	-20...+90	10...25	150...300	1.3...1.4	12 ¹² ...10 ¹⁵
Polyvinylchloride, cold resistant	PVC	Y	-40...+70	10...25	150...300	1.4...1.5	10 ¹² ...10 ¹⁵
Polyvinylchloride, flammwidrig	PVC	Y	-30...+70	10...25	150...250	1.3...1.6	10 ¹² ...10 ¹⁵
High pressure polyethylene	HDPE	2Y	-50...+70	20...30	500	0.95...0.98	10 ¹⁷
Low pressure polyethylene	LDPE	2Y	-50...+100	30	800	0.918...0.935	10 ¹⁷
Polyamide	PA	4Y	-40...+80	50...180	200...300	1.10...1.15	10 ¹⁴
Polybutylen terephthalate	PBTP	-	-60...+110	50...100	50...300	1.3	10 ¹⁶
Polytetrafluorethylene	PTFE	5Y	-190...+260	14...40	240...400	2.0...2.3	10 ¹⁸
Tetrafluorethylene-hexafluorpropylene copolymer	FEP	6Y	-100...+200	20...25	250...350	2.0...2.3	10 ¹⁸
Ethylen-tetrafluorethylen	ETFE	7Y	-100...+150	40...50	100...300	1.6...1.8	10 ¹⁶
Polypropylene	PP	9Y	-50...+90	30...50	300	0.91	10 ¹⁷
Polyurethane	PUR	11Y	-40...+100	30...45	300...600	1.15...1.20	10 ¹²
Thermoplastic polyolefin elastomer	TPE	12Y	-70...+125	3...25	280...650	0.9...1.2	10 ¹²
Silicone rubber	SI	2G	-60...+180	5...10	200...350	1.2...1.3	10 ¹⁵
Ethylene propylen rubber	EPM/EPDM	3G	-30...+125	5...20	200...450	1.3...1.6	10 ¹⁴
Ethylen vinyl acetate	EVA	4G	-30...+125	5	200	1.3...1.5	10 ¹³
Chloropren-rubber	CR	5G	-40...+100	25	450	1.4...1.7	10 ¹³
Flame retardant Polyethylene	FRPE	H	-30...+70	5...10	100...150	1.4...1.6	10 ¹³

Material	Code	Shore-hardness A.D	Resistance to weathering (t)	Fuel resistance	Oil resistance	Flammability
Polyvinylchloride	PVC	70...95	moderate	moderate	good	self-extinguishing
Polyvinylchloride, heat resistant	PVC	70...95	moderate	moderate	good	self-extinguishing
Polyvinylchloride, cold resistant	PVC	70...95	moderate	moderate	good	self-extinguishing
Polyvinylchloride, flammwidrig	PVC	80...90	moderate	moderate	good	not flammable
High pressure polyethylene	HDPE	60...62	good	poor	moderate	flammable
Low pressure polyethylene	LDPE	43...50	moderate	poor	moderate	flammable
Polyamide	PA	60...70	good	moderate	good	flammable
Polybutylen terephthalate	PBTP	80 (D)	good	good	good	flammable
Polytetrafluorethylene	PTFE	55...65	very good	very good	very good	not flammable
Tetrafluorethylene-hexafluorpropylene copolymer	FEP	55...60	very good	very good	very good	not flammable
Ethylen-tetrafluorethylen	ETFE	70...75	very good	very good	very good	not flammable
Polypropylene	PP	55...60	moderate	moderate	moderate	flammable
Polyurethane	PUR	80...100	very good	good	good	self-extinguishing
Thermoplastic polyolefin elastomer	TPE	50...90	very good	good	very good	flammable
Silicone rubber	SI	40...80	very good	poor	moderate	high ignition temp.
Ethylene propylen rubber	EPM/EPDM	65...85	good	poor	poor	flammable
Ethylen vinyl acetate	EVA	70...80	good	poor	poor	flammable
Chloropren-rubber	CR	55...70	very good	poor	good	self-extinguishing
Flame retardant Polyethylene	FRPE	45...50	good	moderate	moderate	self-extinguishing



INTERNATIONAL IDENTIFICATION COLOURS FOR TEMPERATURE MEASUREMENT TECHNOLOGY

THERMOCOUPLES

Type	Pole	Material	Standard				
			 IEC 60584-3	 DIN 43714	 ISA MC 96.1	 BS 4937	 NF C 42-324
T	+	Copper (Cu)					
	-	Copper-Nickel (Cu Ni)					
U	+	Copper (Cu)					
	-	Copper-Nickel (Cu Ni)					
J	+	Iron (Fe)					
	-	Copper-Nickel (Cu Ni)					
L	+	Iron (Fe)					
	-	Copper-Nickel (Cu Ni)					
E	+	Nickel-Chrome (Ni Cr)					
	-	Copper-Nickel (Cu Ni)					
K	+	Nickel-Chrome (Ni Cr) KCA: Iron (Fe) KCB: Copper (Cu)					
	-	Nickel (Ni) KCA: Copper-Nickel (Cu Ni) KCB: Copper-Nickel (Cu Ni)					
N	+	Nickel-Chrome-Silicon (Ni Cr Si) NC: Copper (Cu)					
	-	Nickel-Silicon (Ni Si) NC: Copper-Nickel (Cu Ni)					
R	+	Platinum-13% Rhodium (Pt 13 Rh) RCA/RCB: Copper (Cu)					
	-	Platinum (Pt) RCA/RCB: Copper-Nickel (Cu Ni)					
S	+	Platinum-10% Rhodium (Pt 10 Rh) SCA/SCB: Copper (Cu)					
	-	Platinum (Pt) SCA/SCB: Copper-Nickel (Cu Ni)					
B	+	Platinum-30% Rhodium (Pt 30 Rh) BC: Copper (Cu)					
	-	Platinum-6% Rhodium (Pt 6 Rh) BC: Copper (Cu)					



LAN - FIRE BEHAVIOUR, FIRE PROPAGATION AND CALORIFIC POTENTIAL

The European standards EN 50167, EN 50168 and EN 50169 require not only screens but also halogen-free outer sheaths for data cables. Consideration and adherence to these standards is particularly recommended for public facilities like hospitals, schools and airports. Moreover, the use of halogen-free cables is recommended for buildings with a high concentration of persons or material goods.

Cables with PVC sheath

PVC standard materials can propagate flames under fire conditions, and in combination with moisture (e.g. extinguishing water) they can generate hydrochloric acid (HCl) by splitting off hydrogen chloride gas. In addition, burning PVC (polyvinyl chloride) causes strong smoke development, and corrosive damage to buildings and equipment can often reach a degree far more severe than the actual fire damage.

All **LAN and XLAN-data cables** are manufactured in compliance with fire propagation behaviour according to IEC 60332-1. Manufacturing in accordance with the stricter IEC 60332-3 is possible on demand.

Cables with halogen-free sheath

For these cables, materials are used which do not contain halogens (e.g. chlorine) and do not release corrosive gases under fire conditions. The content of toxic gases is also reduced to a minimum, and smoke development and flame propagation are barely present or possible. Designation notes on the cable are e.g. the abbreviations FRNC or LSOH.

In detail these designations have the following meaning:

FR	flame-retardant (inhibiting flame propagation)
NC	non-corrosive (no corrosive constituents)
LS	low-smoke (low smoke development)
OH	zero-halogen (halogen-free)

Using these materials is safety-relevant because free vision in corridors and escape routes is maintained. This, however, requires the use of such materials for other products as well, e.g. for energy cables or cable routing ducts.

All our data cables can be supplied with these halogen-free and flame-retardant sheath materials upon request. These versions are necessary where utmost importance is ascribed to safety. Additional costs for these cables are relatively low.

Calorific potential (kWh/m), (MJ/m)

There are many different combustible installations or products in every building. Some of them are cables and wires, which, although perhaps concealed in intermediate ceilings or ducts, can represent a substantial component, especially in administration buildings. These cables have different energy (calorific) values and can increase the total calorific potential of a building significantly. This fact should already be considered at the planning stage in order to minimise the fire load amounts.



LAN - PLANNING AND INSTALLATION ADVICE

PLANNING ADVICE

- Fibre-optic cables (FOC) are recommended for establishing the PRIMARY area, whereby the site distributor is usually star-connected to the individual building distributors
- The SECONDARY area can be established using both fibreoptic and copper cables (FOC is recommended), and the structure can be star- or ring-connected.
- The TERTIARY area is designed as star connection consisting of copper cables. 4 pairs covered with a foil screen and a conductor diameter of 0.51 mm are the minimum recommendation.
- In order to cover future applications and requirements, cables with individual pair screening and an overall braid screen are preferable. (higher near-end-crosstalk attenuation and better EMC behaviour)
- Halogen-free cables are recommended for buildings with a high concentration of material goods or persons.
- When selecting the cable type, the system reserves should be designed for an application period of 10-15 years.

- It is also important that all contained components are either screened or unscreened. Existing standards are for facilitation and safety and should be observed.
- In the TERTIARY area sufficiently dimensioned cable runs should be planned due to the high cable density in this section.

INSTALLATION ADVICE

- In the tertiary area a maximum cable length of 90 m between the storey distribution boards and the workplace sockets should be observed.
- Attention should also be paid to the grounding balance. The grounding potential difference between any grounding points may not exceed 1 V.
- In combined cable runs energy and telecommunication cables are to be separated by a metallic middle web.
- The cables should be used in closed and dry rooms, and the cable runs should be protected against aggressive chemicals and rodents.
- At storey breakthroughs a subsequent fire barrier is necessary to protect the riser.

INSTALLATION GUIDELINES

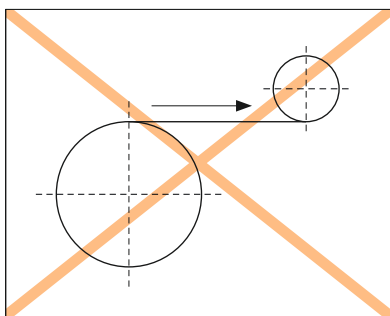

Do not unwind cables from the drum against their original running direction

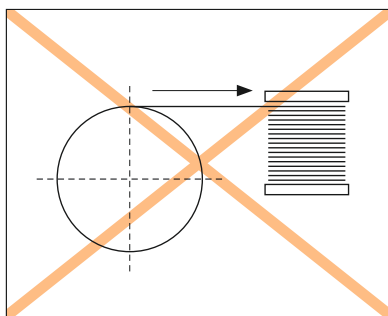

Deflecting the cables is also impermissible.

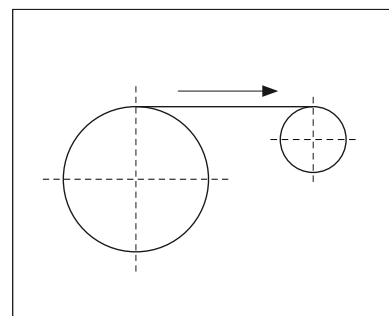

The drum should always be laid horizontally, perhaps on a balancing stand, to avoid mechanical loads.

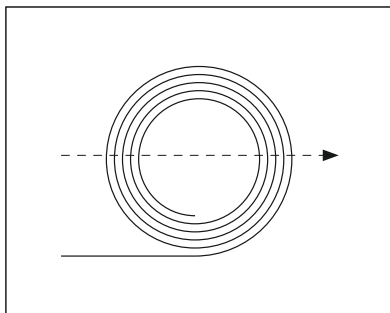

Cable coils should always be placed in a vertical position and unrolled on the floor to avoid a deflecting effect. If there is not enough space for unwinding the required length, a sufficient bending must be observed when feeding back the cable.

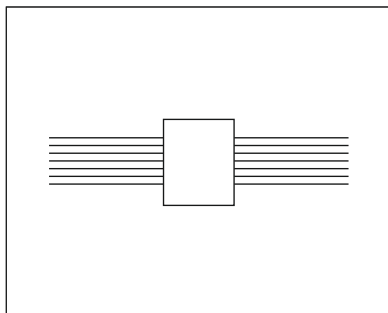

A cable bunch should always lie stretched to avoid potential jammings during installation. If several cables are laid parallel in cable trays, it is recommended to bunch them using a cable tie or insulating tape.

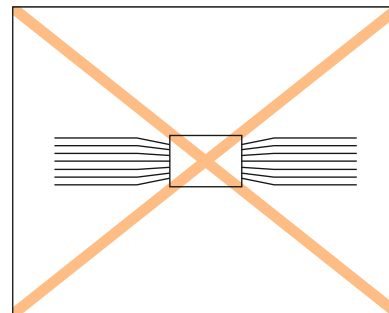

Crushing the individual cables should be avoided when assembling them into bunches.

LAN - PLANNING AND INSTALLATION ADVICE

TENSILE LOAD DURING AND AFTER INSTALLATION

Data cables should be subjected to the lowest possible mechanical loads. In relevant standards 5 daN / qmm² Cu conductor are indicated as maximum permissible traction. Depending on the number of pairs and the overall screen construction, the maximum tensile load values are as follows:

Conductor dimension	Ø NW (mm)	without braid		with braid	
		2 Pairs	4 Pairs	2 Pairs	4 Pairs
AWG 26/7	7 x 0.16	30 N	60 N	70 N	100 N
AWG 24	0.51	50 N	90 N	90 N	150 N
AWG 23	0.57	-	-	130 N	190 N
Ø 0.6	0.6	70 N	120 N	160 N	240 N
AWG 22	0.64	80 N	150 N	170 N	250 N

Attention should be paid to the fact that cables should not be pulled too strongly when bending them around sharp corners or edges. A mechanical load which is too strong can affect the transmission characteristics.

The minimum bending radius may not be less than the octuple cable diameter under installed conditions.

The radius can be reduced to the quadruple cable diameter. In both development and production of LAN cables care is taken to achieve the most solid and compact cable construction so that substantial losses of transmission parameters do not occur, even if these installation guidelines cannot be observed due to local conditions.

LAN - INSTRUCTIONS FOR CONNECTION

SCREENED CABLES (FOIL)

The cable ends are to be stripped approx. 10 cm. Then the individual pairs can be straightened corresponding to the pin connection and cut to the required length. The dismantled cable length should be as short as possible to maintain the original twisting. For cable types with aluminium-clad plastic foil care should be taken that the coloured (usually the outer) side is non-conducting. The foil is to be folded back approx. 15 mm over the sheath (so that the conducting side is outside) and fixed with the drain wire. According to EN 50173 maximum untwisting of the pairs may be 13 mm for contacting.

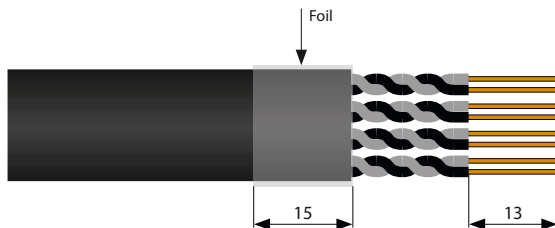

SCREENED CABLES (FOIL + BRAID)

The screen should always be applied as largely as possible. A possibly present drain wire is only to be used for fixing and not for exclusive contacting. The braid is the only component to be folded back, the foil is not required for screen continuity and can be cut off.

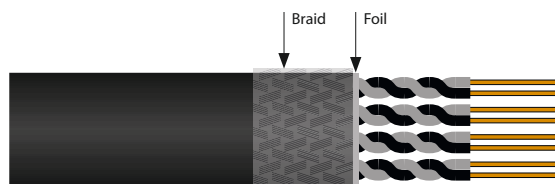

PIN CONNECTION

The combination of pins and pairs is described in the applicable standards as follows:

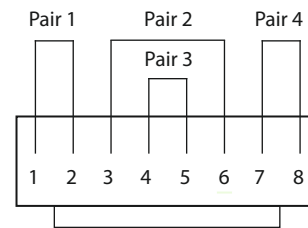

Norm	Pair 1	Pair 2	Pair 3	Pair 4
ISO/IEC 11801 EN 50173	Pair numbers and colours are not defined			
EIA/TIA-568-B.2 (T568A) EIA/TIA-568-B.2 (T568B)	whbu-bu	whor-or	whgn-gn	whbn-bn

See installation guidelines of the respective component manufacturer for corresponding pair application to the connection system.

LAN - KEY CABLE PARAMETERS

Characteristic impedance – Z (Ω)

Characteristic impedance describes the terminal resistance of the cable without any line reflections, i.e. the total electrical power fed into a cable by a signal source is transmitted to the output impedance, only reduced by the cable attenuation. The main function of a data cable is to transfer electrical pulse groups. The higher the data bit rate required, the higher the frequency bandwidth of the transmission channel (e.g. cable) to be selected. The output and input impedance values of devices connected to the cable are to be the same as the cable itself (= adapted). Otherwise transmission can be incorrect due to impulse distortions. The characteristic impedance of balanced cables for telecommunications is standardised according to EN 50173-1 bzw. ISO/IEC 11801:

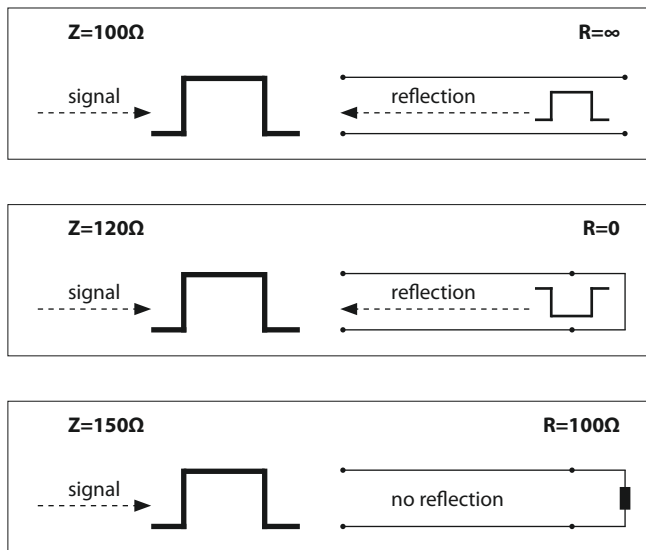

Attenuation – α (dB)

The cable attenuation reduces the incoming signal amplitude at the output and thereby, among other things, limits the applicable free cable length. Ohmic loss resistances in longitudinal direction are generated depending on the conductor material and cross-sectional area. Additionally the skin effect (current displacement) reduces the effective conductor cross-section depending on the frequency increase. The frequency-dependence of the selected core insulation material causes additional capacitive loss resistances between conductors. The cable attenuation, which is usually indicated for a reference length of 100 m, defines the transmission ratio between send and receive level.

Near-End Crosstalk Attenuation – NEXT (dB)

Crosstalk describes the unintended crossing of signal energy into an adjacent circuit. In this case the electromagnetic field generated by the useful signal of a pair of cores creates a spurious signal in an adjacent pair at the same cable end (NEAR END). The near-end crosstalk attenuation (NEXT) results from the performance ratio „power input at the disturbing pair“ to „power output at the disturbed pair“ at the same cable end.

FAR-End Crosstalk Attenuation – FEXT (dB)

The electromagnetic field of the useful signal at the input of a pair of cores creates a spurious signal on the output side (FAR END) of an adjacent pair. The far-end crosstalk attenuation (FEXT) results from the performance ratio „power input at the disturbing pair“ to „power output at the disturbed pair“ at the.

ELFEXT (dB)

ELFEXT (Equal-Level Far-End Crosstalk) describes the difference between FEXT and attenuation and could also be designated as Far-End ACR. ELFEXT is a calculated value defining the ratio between crosstalk interference level and receive level.

$$ELFEXT_{(f)} = FEXT_{(f)} - \alpha_{(f)}$$

Power Sum NEXT – PSNEXT (dB)

Power sum NEXT is the total near-end crosstalk power sum, i.e. the amount of all spurious signals coupled into a pair of conductors. For twin cables PSNEXT is equal to NEXT. For cables with more than two pairs the difference increases continuously due to the fact that the spurious signals of all adjacent pairs of cores are coupled into one pair of conductors.

Attenuation to Crosstalk Ratio – ACR (dB)

ACR is a characteristic variable for basic transmission quality rating of a cable. It describes the ratio between the strength of the incoming useful signal and the disturbing noise signal of an adjacent pair of cores.

$$ACR_{(f)} = NEXT_{(f)} - \alpha_{(f)}$$

It is important that the useful signal is always stronger than the noise signal, which is indicated by a positive ACR value. At the highest transmission frequency the recommended ACR value of a LINK should be ≥ 4 dB.

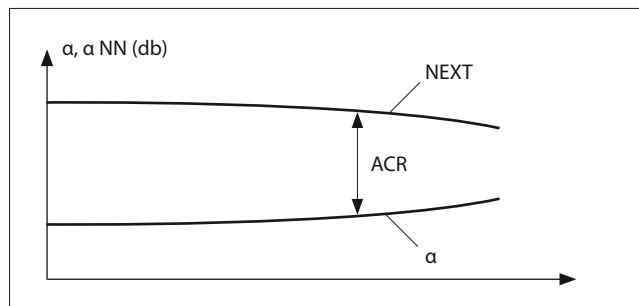

LAN - KEY CABLE PARAMETERS

Return Loss – RL (dB)

If different characteristic impedance values or inhomogeneities occur within a cable system (e.g. between the cable and a component), the fed signal energy at this disturbing point is partially reflected (= backscatter). Return loss is the ratio between fed and backscattered energy and reflects the homogeneity of a cable or a transmission path. These reflections should be minimised in order to ensure faultless transmission.

Delay Skew (ns)

Delay Skew describes the difference between signal transit times in the individual pairs of a cable (caused by different twisting lengths of the pair). This value - it should be as low as possible - is important for multistage transfer methods because the transit time difference is to be balanced by the receiver.

Nominal Velocity of Propagation – NVP (%)

This value indicates the propagation speed of the electrical signal in the cable. Expressed in %, this value is related to light speed in vacuum. The NVP value is also required for length determination of installed cables.

$$\text{NVP} = \frac{\text{expansion speed of the signal}}{\text{speed of light in vacuum}} \times 100 \%$$

$$\text{NVP} = 77 \% \text{ expresses a transit time of approx. } 0,33 / \text{NVP} = 4,2 \text{ ns / m}$$

Transfer impedance – R_k (Ω/m)

Electromagnetic compatibility (EMC) gains more and more significance along with increasing transmission frequencies in data cables. In order to protect cables against unwanted noise influence and surrounding electrical equipment against interfering transmissions of cables respectively, for today's data cables more and more attention is paid to a sufficient field screen.

Each current-carrying conductor creates an electromagnetic field. The magnetic field of a pair of cores is to a large extent compensated by twisting the cores, while the electric field is compensated by applying a foil and/or braid screen. The transfer impedance (coupling resistance) is frequency-dependent and increases linearly with the cable length. It is indicated in mΩ/m; the value should be as low as possible. The lower the transfer impedance, the more efficient is the screening effect and thus contributes substantially to the EMC value optimisation of an overall system.

The selection and quality of the earthing point, which should be as low-ohmic as possible for the entire frequency range, is also important for the screening effect.

Using a double screen (foil and overall screen) results in better screening effects especially in the higher frequency range. The transfer impedance can describe the effectiveness of the cable screen: the lower its value the better the screening effect.



CODES

CODES FOR CONTROL CABLES



1 Identification	Z flat twin flexible cord
N VDE standard	GL glass fibre yarn
(N) in resembl. to VDE	Li bunched conductor acc. to VDE 0812
X in resembl. to VDE	LiF bunched conductor acc. to VDE 0812, extra fine stranded
2 Insulation	4 Particularities
Y PVC	T support wire
X cross-linked, thermoplastic synthetic materials	Ö enhanced oil-resistance
G elastomers	U flame-resistant
HX cross-linked, halogen-free materials	w heat resistant
H halogen-free materials	FE insulation integrity
2Y PE	C copper wire braid
3 Type of cable	D copper wire spinning (weir)
A insulation cable	S steel wire braid
D solid cable	5 Sheath
AF flexible stranded cable	Y PVC
F flexible cable for fittings	X crosslinked, thermoplastic synthetic materials
L flourescent tube cable	G elastomers
LH direct line, minor mechanical stress	H halogen-free materials
MH MH direct line, medium mechanical stress	PUR polyurethane
SH direct line, heavy mechanical stress	6 Core identification
SSH direct line, specific stress	O without protective conductor
SL control cable/welding cable	J with protective conductor
S control cable	Z cores with number-printing
LS control cable with minor mechanical stress	B cores with colour-coding
FL flat flexible cable	7 Number of cores
Si silicone cable	8 Nominal conductor cross-section (mm²)

CODES FOR TELECOMMUNICATION LINES



1 Basic Type	6 Number of stranding elements
A outdoor cable	7 Stranding element
G mining cable	1 Single conductor
J installation cable	2 Pair
S switchboard cable	3 Triple
T distribution cable	4 Quad
2 Additional Information	5 Five
B lightning protection	8 Conductor diameter or Conductor cross-section
J induction protect.	9 Stranding element
E electronics	St 0 star-quad (in general)
LI stranded wire	St I star-quad (tele- comm. cable)
3 Insulation	St III star-quad (local cable)
Y PVC	St IV star-quad for trans mission up to 120 kHz
2Y PE	St V star-quad for trans mission up to 550 kHz
02Y Foam-PE	St VI star-quad for trans mission up to 17 MHz
02YS Foam-Skin PE	TF carrier frequency
5Y PTFE	P paired
6Y FEP	Kx coaxial pair
7Y ETFE	DM Dieselhorst-Martin-quad
9Y PP	PimF pair in metal foil
09YS Foam-Skin PP	VimF quad in metal foil
4 Construction over conductor stranding	10 Type of stranding
F petroleum jelly filling	Lg layer-stranding
L aluminium Sheath	Bd unit stranding
C copper wire braid	Bd Si unit stranding, simatic colour code
D copper wire spinning (weir)	EXAMPLES FOR CODE DESIGNATION
S steel wire braid	200 paired outdoor telephone cable for local grids, foam-skin PE-sheathed, composite layer sheath from coated aluminium tape and PE outer sheath, star-quad unit stranding, conductor diameter 0.4 mm
DS steel wire spinning (weir)	A-02YS(L)2Y 200x2x0.4 STIII Bd
(K) copper tape screen	
(L) aluminium tape	
(St) metal foil screen (Al/PE)	
(mS) magnetic screen	
(Z) strain bearing element	
5 Sheath	
Y PVC	
Y-FR PVC flame retardent IEC 332.3	
Yv PVC reinforced	
Yw PVC heat resistant	
2Y PE	
H halogen-free flame retardant	



CODES

CODE FOR HARMONISED CABLES ACC. TO DIN 57 292/ VDE 0292

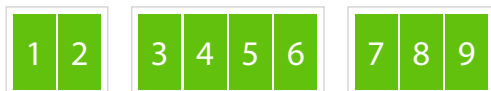

1 Identification according designation

- H** harmonised designation
- A** national type

2 Nominal voltage (U₀ / U)

- 03** 300/300V
- 05** 300/500V
- 07** 450/750V

3 Insulation

- V** PVC
- R** natural and/ or synthetic rubber
- S** silicone rubber

4 Sheath

- V** PVC
- R** natural and/ or synthetic rubber
- N** chloroprene rubber
- J** glass fibre braid
- T** textile braid

5 Particularities in construction

- without
- H** flat, divisible cable
- H2** flat, non-divisible cable

6 Conductor

- U** solid
- R** multi-wired
- K** fine-wired for fixed installation
- F** fine-wired for flexible installation
- H** extra fine-wired
- Y** tinsel wire

7 Number of cores

8 Protective conductor

- X** without protective conductor
- G** with protective conductor

9 Nominal conductor cross-section in mm²

EXAMPLES FOR CODE DESIGNATION

PVC-sheathed wire 2.5 mm ² , green-yellow	H07V-U 2.5 gnye
Light tough-rubber sheathed wires	
3 cores, 1.5 mm ² ,	
with protective conductor, green-yellow	H05RR-F 3G1.5
2 cores, 1.5 mm ² ,	
without protective conductor	H05RR-F 2G1.5
PCV-sheathed wire	
round, 4 cores, 2.5 mm ²	H05VV-F 4G2.5

CODE FOR POWER CABLES ACC. TO VDE 0276

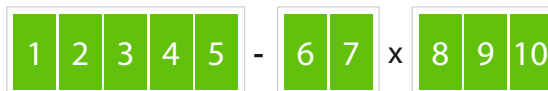

1 Identification

- N** VDE-standard
- X** in resemblance to VDE

2 Type of conductor

- A** aluminium conductor
- copper conductor

3 Insulation

- Y** PVC
- 2X** cross-linked polyethylene (XLPE, german: VPE)

4 Concentric conductor, screen

- C** concentric copper conductor (helical)
- CW** concentric copper conductor (wave-form)

5 Sheath

- Y** PVC
- 2Y** PE

6 Protective conductor

- O** without protective conductor
- J** with protective conductor

7 Number of cores

8 Nominal conductor cross-section in mm²

9 Conductor

- R** circular conductor
- S** sector-shaped conductor
- E** solid-wired
- M** multi-wired conductor cross section (mm²)

10 Nominal voltage

U₀ / U

EXAMPLES FOR CODE DESIGNATION

Power cable acc. to standard, insulation and sheath from PVC, with green-yellow core, 3 cores, nominal cross-section 16 mm², solid circular conductor, nominal voltage 0.6/1 kV

NY-Y-J 3 x 16 RE 0.6/1 kV

Power cables acc. to standard, aluminium conductor, insulation and sheath from PVC, with protective conductor, 3 cores, with wave-form concentric conductor, nominal cross-section 25 mm², solid sector-shaped conductor, nominal voltage 0.6/1 kV

NACWY-J 3 x 25 SE 0.6/1kV



KTG - CABLE DRUMS

DRUM-TABLE

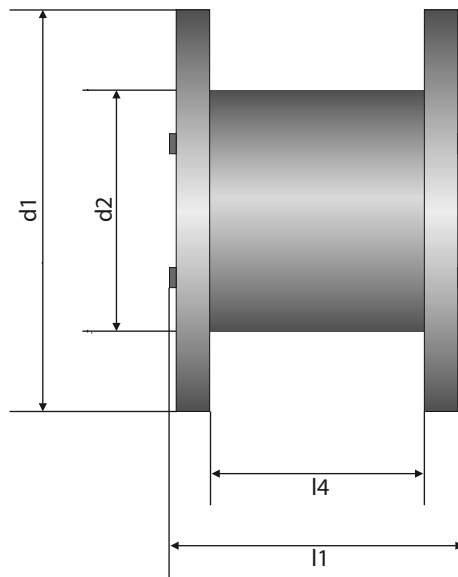

Nominal size of drum	d1 Flange-Ø	d2 Core-Ø	l1 Width overall	l4 Width internal	Approx. drum weight	Max. carrying capacity
	mm	mm	mm	mm	kg	kg
plastic drums						
050	500	150	456	404	4	100
070	710	355	510	400	15	250
080	800	400	510	400	16	350
090	900	450	680	560	23	400
100	1000	500	704	560	32	500
wooden drums						
051	500	150	470	410	8	100
071	710	355	520	400	25	250
081	800	400	520	400	31	400
091	900	450	690	560	47	750
101	1000	500	710	560	71	900
121	1250	630	890	670	144	1700
141	1400	710	890	670	175	2000
161	1600	800	1100	850	280	3000
181	1800	1000	1100	840	380	4000
wooden drums with iron hooping						
120	1250	630	890	670	165	170



KTG - CABLE DRUMS

CAPACITY (windable cable length in metres)

Ø Cable mm	Nominal size of KTG - cable drum													Ø Cable mm
	051	071	081	091	101	121	141	161	181	201	221	251	281	
3	5324													3
4	2466													4
5	1578													5
6	1508	2328	3080	5679										6
7	1105	1706	2257	4165	5286									7
8	844	1303	1724	3183	4040									8
9	665	1026	1358	2510	3186									9
10	537	829	1097	2029	2576	5038								10
11	443	683	904	1674	2125	4157	5296							11
12	371	573	758	1404	1782	3488	4444							12
13	315	487	644	1194	1516	2967	3780							13
14	271	418	554	1028	1304	2555	3255	5595						14
15	235	364	481	893	1134	2222	2831	4868	5639					15
16	206	319	422	784	995	1950	2484	4274	4959					16
17	182	281	373	693	880	1724	2197	3781	4380					17
18	162	250	331	617	783	1536	1957	3368	3902	5287				18
19		224	297	553	701	1376	1753	3019	3498	4740				19
20		202	267	498	632	1240	1580	2722	3153	4274	5949			20
21		179	238	444	565	1112	1419	2448	2836	3845	5357			21
22		160	212	398	507	1002	1279	2211	2563	3474	4845	5857		22
23		143	191	359	458	906	1159	2006	2325	3153	4401	5322		23
24		128	172	324	414	823	1053	1826	2118	2871	4012	4854		24
25		115	155	294	376	750	961	1669	1935	2624	3670	4443		25
26		104	140	267	342	685	879	1529	1774	2406	3368	4079	5869	26
27			128	243	313	625	807	1406	1631	2212	3100	3757	5409	27
28			116	223	287	577	742	1296	1504	2039	2861	3469	4998	28
29			106	204	263	532	685	1197	1390	1885	2647	3211	4630	29
30				187	242	491	633	1109	1288	1746	2454	2980	4300	30
31				172	223	454	587	1029	1196	1612	2281	2771	4002	31
32				159	206	424	545	957	1112	1508	2125	2582	3732	32
33				147	191	391	507	892	1037	1406	1982	2411	3487	33
34				136	177	364	472	833	968	1313	1853	2255	3265	34
35				126	164	340	441	779	906	1228	1735	2112	6061	35
36				117	153	317	412	730	848	1150	1627	1982	2875	36
37				108	142	296	386	684	796	1079	1529	1863	2704	37
38				101	133	277	362	643	748	1014	1438	1753	2548	38
39					124	260	339	605	704	954	1354	1653	2403	39
40					116	244	319	570	663	899	1277	1560	2270	40
41					108	229	300	537	625	848	1206	1473	2146	41
42					101	216	283	507	591	801	1140	1394	2032	42
43						203	267	479	558	757	1079	1320	1926	43
44						192	252	453	528	716	1022	1251	1827	44
45						181	238	429	500	678	969	1187	1736	45
46						171	225	407	474	643	920	1128	1650	46
47						161	213	386	450	610	874	1072	1570	47
48						153	202	367	428	579	813	1020	1495	48
49						145	192	331	406	551	791	971	1425	49
50						137	182	315	387	524	753	926	1360	50



NON-RETURNABLE DRUMS

DRUM-TABLE

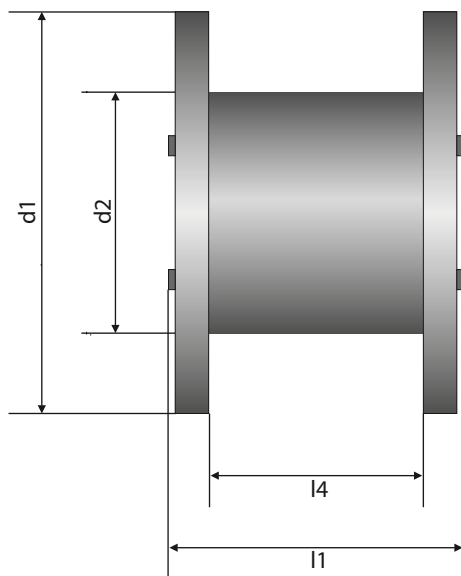

Nominal size of drum	d1 Flange-Ø	d2 Core-Ø	l1 Width overall	l4 Width internal	Weight
	mm	mm	mm	mm	kg
plywood drums					
040	400	150	420	404	3.3
050	500	150	420	404	3.5
060	600	150	420	404	6.0
076	755	315	420	396	9.3
wooden drums					
70	710	355	502	400	24.0
80	800	400	502	400	30.0
90	900	450	662	560	40.0
100	1000	500	662	560	54.0
120	1250	630	830	710	140.0
140	1400	710	860	710	170.0
160	1600	800	1050	900	260.0
180	1800	1000	1100	840	360.0
200	2000	1250	1350	1045	550.0
220	2240	1400	1450	1140	710.0
250	2500	1400	1450	1140	875.0



NON-RETURNABLE DRUMS

CAPACITY (windable cable length in metres)

Ø Cable mm	Nominal size of cable drum												Ø Cable mm
	EW40	EW50	EW60	EW76	NG8	NG9	NG10	NG12	NG14	NG16	NG18	NG20	
2	5737												2
3	2550	6181	9615										3
4	1434	3477	5409	6246									4
5	756	1833	2851	3998	4800								5
6	525	1273	1980	2776	3300	5300							6
7	386	935	1454	2040	2400	3900							7
8	295	700	1100	1562	1800	2900							8
9	233	566	880	1200	1400	2300	2700						9
10	176	425	662	928	1100	1700	2100						10
11		352	547	767	900	1400	1800						11
12		295	460	644	780	1200	1500	2600					12
13		252	392	549	660	1000	1200	2200					13
14		217	338	473	570	900	1100	1900					14
15		189	294	412	500	780	950	1600	2700				15
16				363		660	850	1400	2400				16
17				321		570	750	1300	2100				17
18				286		500	670	1100	1900				18
19				257			600	1000	1700				19
20				232			500	940	1500	2200	3300		20
21								850	1400	2000	3000		21
22								780	1200	1800	2700		22
23								700	1100	1600	2500		23
24								650	1000	1500	2300		24
25								600	950	1400	2000		25
26								560	900	1300	1900		26
27								500	850	1200	1800		27
28									750	1100	1700		28
29									700	1000	1600		29
30									680	980	1500		30
31									600	900	1400	2000	31
32									550	850	1300	1970	32
33									500	800	1200	1850	33
34										750	1100	1750	34
35										700	1150	1650	35
36										680	1000	1550	36
37										640	980	1450	37
38										600	930	1400	38
39										580	890	1300	39
40										550	840	1250	40
41										520	800	1200	41
42										500	760	1150	42
43											730	1100	43
44											700	1000	44
45											660	990	45
46											640	950	46
47											610	910	47
48											580	870	48
49											560	840	49
50											530	800	50



PROPERTIES AND TEST SPECIFICATIONS

BEHAVIOUR UNDER FIRE CONDITIONS

The flammability of cables and wires is judged in accordance with a variety of standards.

Flame resistance acc. to

- DIN VDE 0482 part 332-1
- EN 60332-1
- IEC 60332 part 1

Flame resistance describes the ability of a cable to resist flame propagation. This ability is demonstrated by testing the flammability.

The test is conducted on single cores or cables vertically secured and exposed to a standard test flame for a specified time period of 60 seconds.

The test is considered to be passed where flaming of the specimen ceases of its own accord within a determined length of time.

Flame retardant acc. to

- DIN VDE 0482 part 332-2
- EN 60332-3
- IEC 60332 part 3

Contrary to flame resistance, a cable is designated as flame-retardant if it is capable of retarding flame propagation after a flaming period of 20 minutes. For this practice-oriented test a cable bunch attached to a vertically arranged ladder is used. The test is considered to be passed where flaming of the specimens ceases of its own accord after a flaming period of 20 minutes.

CORROSIVE GASES

Combustion gases developing during fire are very problematic. They can be extremely toxic and very dangerous for people and animals. In combination with extinguishing water these combustion gases also generate aggressive reaction products (acids), which can cause serious damage to facilities and buildings.

The test for **corrosiveness of combustion gases is conducted** acc. to

- DIN VDE 0482 part 267
- EN 50267
- EN 60754

The pH-value and conductivity are to be determined in order to judge the corrosiveness of developing gases. This test also allows the detection of very small amounts of halogen-free components. The combustion of synthetic materials, e.g. PVC, causes dense smoke development and a drastic deterioration of visibility conditions. As a consequence, escape routes may be impassable, and the work and rescue efforts of fire brigades more difficult.

The **density of smoke** developing under fire conditions is judged acc. to

- DIN VDE 0482 Part 1034
- IEC 61034

This test method allows smoke density measurement of burning cables under practice-oriented conditions. The smoke density of various materials is determined by means of comparative testing. A photometric system equipped with a light source (100W) and a selenium photocell records the light obscuration caused by developing smoke.



PROPERTIES AND TEST SPECIFICATIONS

INSULATION INTEGRITY

Many conventional cables malfunction due to melting of synthetic materials under fire conditions. As a consequence, short circuits cause downtime of necessary equipment. Applicable constructive measures and the use of appropriate materials can help maintain the insulation integrity of a cable for a certain time period. Testing is conducted acc. to

- DIN VDE 0472 Part 814
- DIN VDE 0482 Part 200
- EN 50200

This test method determines the insulation integrity of cables and insulated wires under direct fire exposure. Cables tested in accordance with this standard are marked with **FE 180** behind the abbreviated construction designation, whereas **FE** is the abbreviation for fire exposure, not for functional endurance.

The specimen of a single cable is secured above the burner in a horizontal position and connected to a voltage source (power cables and insulated wires are tested at 400 V, telecommunication cables and wires at 110 V). Metallic screens are connected together and earthed.

The burner is ignited, and the flame is adjusted to a temperature of at least 750°C by means of a temperature sensor. The energised specimen is then lowered into the flame, and a timer is started. Unless otherwise specified in the relevant product specifications, the test period shall be 180 minutes.

The test is considered to be passed where no short circuit or current flow interruption occurs within the scheduled duration.

FUNCTIONAL ENDURANCE

The test of insulation integrity **FE** should not to be mistaken for the test of **functional endurance E acc. to DIN 4102-12**. In this case an entire cable system is tested instead of a single cable. Cable systems are cables and wires (power cables and lines, installation cables for telecommunication and information processing systems) together with their corresponding connection elements, cable trays and mountings.

The necessity of functional endurance is required by law, which, among other things, stipulates a functional endurance of at least 30 minutes (E 30) for

- fire alarm systems
- security lighting and
- passenger lift systems

Furthermore, functional endurance over a period of 90 minutes is required for

- extinguishing water pumps
- ventilation systems
- smoke outlets and
- fire brigade lifts

The test is generally conducted by an officially recognised testing centre. The test stand is to be in accordance with DIN 4102 Part 2 and must have a minimum length of 3 metres. The test temperature follows the standard temperature-time curve.

Several test specimens from each cable construction with integrated functional endurance are to be tested, namely

- power cables
2 specimens 4 x 1.5 and 2 specimens 4 x 50 or greater
- telecommunication cables
2 specimens of the smallest permissible number of cores or pairs

The test specimens are to be suspended using practical means, applied to supporting structures provided for this purpose or attached directly to the ceiling or wall. The test voltage is to be 400 V for power cables and 110 V for telecommunication cables.

Functional endurance is proven where no short circuit or current flow interruption occurs in the cable system throughout the fire test. The following classes are distinguished depending on the measured duration of functional endurance:

- E30 > 30 minutes
- E60 > 60 minutes
- E90 > 90 minutes



CE-IDENTIFICATION

General terms

The Single European Market requires a variety of regulations regarding free commodity exchange. Several EC directives for reducing technical trade barriers were enacted to take different national guidelines into account, e.g.

- Construction Products Directive
- Machinery Directive
- EMC Directive
- Low-voltage Directive etc.

EC Low-voltage Directive

Cables and wires fall within the scope of the Low-voltage Directive 2006/95/EC of the European Parliament and the Council from 12th December 2006 on the harmonisation of the laws of Member States relating to Electrical Equipment designed for use within certain voltage limits.

Certificate of Conformity

The manufacturer is required to verify products regarding compliance with existing standards and specifications. The EC Certificate of Conformity certifies this inspection. It contains:

- name and address of the manufacturer
- equipment description
- reference to harmonised standards

- reference to specifications forming the basis of conformity
- year of CE symbol identification

T.K. Kabel oHG issues this Certificate of Conformity for cables and wires falling within the scope of the Low-voltage Directive on demand.

CE identification

The CE identification certifies the conformity of a product with the corresponding EC directives. The requirement for CE marking has been in effect since January 1st, 1997, and relates to all electrical equipment falling within the scope of the Low-voltage Directive.

Identification is made by the manufacturer, thus declaring that all directives applicable to the product are observed.

T.K. Kabel oHG applies the CE symbol using either ink-jet printing on the cable or label marking.



GENERAL

Price basis

Price quotations apply for 1000 metres of cable. Current prices are calculated according to quotations of the non-ferrous metal-working industry using electrolytic copper for conducting purposes (DEL notice), valid on the day of order receipt, plus purchase costs.

Copper price

Cables and wires are sold at daily copper prices (DEL). DEL is the stock exchange listing for German electrolytic copper for conducting purposes, that is 99.5% pure copper. DEL is indicated in EUR/100 kg.

Copper index

Copper index describes the copper weight of each article. If the listed copper index is 68, the corresponding cable contains 68 kg of copper in a length of 1000 metres.

Copper addition

The copper addition (EUR/km) is calculated as follows:

$$\text{copper addition} = \text{copper index} \times \frac{(\text{DEL} + 1\% \text{ purchase costs}) - \text{copper basis}}{100}$$

(kg/km)

VAT

Prices are calculated excluding VAT. It will be charged additionally according to the fiscal regulations currently in force.

Pricing terms

Freight costs included within Germany for a net merchandise value of EUR 1,500.- or more. If the net merchandise value is less than EUR 1,500.-, freight costs will be charged.

Inland payment terms

Payable within 14 days net.

Divergences in measurement, weight, quantity and construction

Divergences related to raw materials or production remain reserved. Trade-customary over- or under-deliveries are permitted.

Short lengths

We reserve the right to deliver up to 10 % of the ordered quantity in short lengths.

Dimensions metre marking

The metre marking is a guide value and not calibration-capable. It does not serve for verifying the delivered length indicated by the cable manufacturer. Only calibrated measuring instruments are to be used for this purpose.

ENVIRONMENT PROTECTION

In product manufacturing we refrain from using hazardous substances according to Directive 2002/95/EC - RoHS. We use only lead-free materials in order to protect our environment. Cable residues, pilot and rejection products are mainly reused at our production sites. Residues of synthetic materials are re-employed in the production process. Furthermore we use recyclable materials for all our packaging and support materials.

Our return service for wooden drums can also help contribute to environment protection. We return your empty wooden drums free of charge, and we can use them repeatedly without losing quality, or without wasting valuable resources.

For drum return please contact:

T.K. Kabel oHG
Geschwister-Scholl-Straße 11
71384 Weinstadt

phone: +49 (0) 7151 60 68 70
fax: +49 (0) 7151 60 91 00
email: info@tk-kabel.de



1. SCOPE

1.1 The following conditions apply to any business relations with our customers (hereinafter referred to as "the Purchaser") as far as they are entrepreneurs in terms of § 14 German Civil Code, legal entities of public law or special funds under public law. The conditions apply particularly to contracts on the sale and/or the delivery of movable goods, regardless of whether we produce the goods or purchase them from subcontractors. The present conditions in their respective version also provide the master agreement to future contracts on the sale and/or the delivery of movable goods with the same Purchaser, excluding the necessity to refer to them in each particular case.

1.2 The Purchaser's General Terms and Conditions of Purchase are hereby expressly vetoed. They shall in no case be mandatory to us, even if we do not expressly contradict them at the conclusion of a contract. The sales terms below apply, even if we implicitly execute the Purchaser's order despite being aware of adverse or divergent conditions.

2. SALES TERMS

2.1 Any order of goods by the Purchaser shall be deemed a binding contractual offer. Unless otherwise indicated in the order, we shall be entitled to accept this contractual offer within 8 business days upon receipt. Acceptance shall be effected by means of order acknowledgement. Orders shall not be regarded as accepted until they have been confirmed by us. Our sales agents act as negotiators, not as contracting representatives. The Purchaser shall not be permitted to assign claims arising out of the contractual relationship established with us to any third parties.

2.2 Prices indicated in our order acknowledgement shall prevail to the account of services rendered.

2.2.1 The price basis of any order acknowledgement is formed by the price list valid on the respective day of acknowledgement in correspondence with the metal quotation agreed upon (usually the day of order receipt). If the metal quotation is omitted on that day, the subsequent metal quotation shall apply.

2.2.2 If we have received a purchase offer in the form of an order we are able to finally acknowledge including the scheduled delivery date (cleared order), we shall calculate the price according to the price list and metal quotation agreed upon. Any final order acknowledgement requires clarification of the customer, the customer's address, the address for invoicing and delivery, the order content stating article quantities and types to be delivered, discounts, delivery requests or delivery dates respectively and special conditions, where applicable.

2.2.3 For business to be processed within 4 months after contract conclusion we shall be entitled to increase prices agreed upon with regard to a short-term change in the metal quotation. The reason for this is that significant variations compared to prices indicated in the order acknowledgement may arise due to the daily redefinition of the metal quotation.

2.2.4 The metal quotation forms the basis of the raw material calculation or the raw material accounting respectively. It is calculated on the basis of the quotation of the Basis UB notice from Südkupfer plus incurred purchase costs.

2.2.5 If stocking up on metal and procurement on Basis UB notice is impossible or not ensured at full volume, we shall account for the actual metal procurement prices plus purchase costs incurred.

2.2.6 For delivery ex distribution centre, prices from the price list valid on the date of distribution and the metal quotation (Basis UB notice or metal procurement price) on the date of distribution shall apply.

2.2.7 If copper is provided to the supplier by the Purchaser, we shall charge the hollow price. The copper shall be consigned to the supplier's control no later than 5 weeks prior to the acknowledged delivery date.

2.3 Our prices are based on the cost conditions of raw material market procurement costs stated to us at the time of order acknowledgement. If these cost conditions change, we shall be entitled to implement a subsequent price adjustment or, as the case may be, to rescind from the aggregated or remaining order, provided that we notify the Purchaser immediately after the changed conditions have become

known to us and, in case of rescission, return payments already received from the Purchaser.

2.4 Call orders

If delivery on call is agreed, the Purchaser undertakes to determine and communicate the time of complete delivery within an appropriate period of one month maximum from the date of order acknowledgement. This shall also apply in case of delivery arrangements for certain acceptance dates. Unless a separate agreement on call-off dates is concluded, call orders shall always be delivered within 3 months from the date of order acknowledgement. If the Purchaser does not adhere to the call commitment, we shall be entitled to sue for acceptance and payment. After expiration of the call commitment the prices of the company T.K. Kabel oHG., valid at the time of delayed calls, shall apply to further call arrangements.

3. DELIVERY TERMS

3.1 Our delivery commitment implies that we are able to stock up with raw materials necessary for the order on raw material quotations prevailing on the date of order acknowledgement. If this precondition is not given, paragraph 2.3 of our General Terms and Conditions shall apply.

3.2 Periods and dates of delivery are always approximated statements. Any delivery period shall start with the despatch of our written order acknowledgement and the delivery date stated therein at the earliest, but, however, not prior to the provision of documents to be procured or materials to be provided by the Purchaser and the observance of payment terms agreed upon.

3.3 The delivery period shall be deemed observed after the delivery item has left our factory or warehouse or if the readiness for shipment is communicated prior to its expiration.

3.4 If subsequent changes or amendments of the delivery contract are agreed, a new delivery period shall be agreed at the same time if the original period cannot be observed due to the changes or amendments. The new delivery period shall not start prior to the despatch of our new order acknowledgement.

3.5 Events of force majeure shall authorise us to delay performance of services for an appropriate period of time or to rescind because of contractual parts not yet fulfilled, provided that we notify the Purchaser immediately after these conditions have become known to us and, in case of rescission, return payments already received from the Purchaser. Strike, lockout, mobilisation, war, embargo, ban on exports and imports, shortage of raw materials and fuels, fire, traffic blockage, interruption of operations or transport as well as similar conditions, even if such conditions occur on the part of sub-suppliers, shall be deemed equivalent to force majeure. Indemnity claims of the Purchaser shall be excluded in cases of force majeure, provided that neither intent nor an act of culpable negligence occurred on our part. This limitation of liability shall not apply to damages resulting from injuries inflicted to the body, life or health.

3.6 The aforementioned conditions shall not even be covered by us if they occur during a current event of default. We shall notify the Purchaser of the beginning and end of such impediments at earliest convenience.

3.7 Delivery commitments and delivery periods shall only be agreed reserving correct and due receipt of the subcontractor's deliveries. If this is not ensured, we shall be entitled to rescind from the contract without compensation, provided that we notify the Purchaser immediately after these conditions have become known to us and, in case of rescission, return payments already received from the Purchaser. We shall not assume any risk of procurement.

3.8 If any delivery period is exceeded, the Purchaser shall be committed to grant us an appropriate grace period, which may not be less than three weeks.

3.9 After expiration of any acceptance period in accordance with the provision stipulated under paragraph 2.4 of these General Terms and Conditions, we shall no longer be committed to deliver. In this case we reserve the discretionary decision to rescind from the contract, to demand advance payment or to condition our delivery on adequate collateral. This shall also apply in the case of conditions becoming known to us, which justify doubts about the Purchaser's creditworthiness, particularly if the Purchaser does not pay

promptly or immediately, despite reminders and overdue claims.

3.10 We reserve the right to deliver up to 10 % of the order quantity in excess or short lengths. Divergences related to raw materials or production remain reserved. Customary excess or short lengths shall be permitted.

3.11 Orders on special services shall exclusively be delivered in manufacturing lengths according to the production conditions.

3.12 Shipping charges

We deliver free to the door for a net merchandise value of € 2500,- or more (on metal basis) or free station of the recipient respectively, this shall apply to inland shipment (mainland). In case of international shipment we deliver free up to the German border. We shall charge additional freight for small orders with a net merchandise value of less than € 2500,- (on metal basis).

3.13 Packaging charges

Packaging shall be free of charge for a net merchandise value of € 250,- or more. Packaging shall be charged at cost price if the value is less than € 250,-.

3.13.1 Returnable drums and barrels belonging to T.K. Kabel and loaned to the Purchaser with our deliveries shall be charged separately. Barrels and drums shall be taken back and credited with 2/3 of the charged value if they are in a good and reusable condition. Any delivery of skeleton containers and euro-pallets shall be effected on exchange. In case of exchange delays caused by the Purchaser, the Purchaser will be charged with the costs incurred by it.

3.13.2 KTG drums (flange diameter 50 to 280 cm) for cables and wires are the property of Kabeltrommel GmbH & Co. KG (KTG), Cologne, and shall be provided to the Purchaser according to KTG's conditions on the transfer of cable drums.

3.13.3 We shall not grant any freight reimbursement for the collection of goods.

3.13.4 The Purchaser shall indemnify the supplier from the obligation to accept returnable products according to § 4 of the Packaging Directive.

4. PAYMENT TERMS

4.1 Invoicing shall be made upon delivery or completion notification. We shall be entitled to assign claims arising out of our business connection.

4.2 Invoices issued to the Purchaser shall be payable as indicated in the invoice.

4.3 In the event of non-compliance with the payment terms we shall be entitled to add interest in the amount of the legal default interest rate currently in force to the invoice amount. The right to enforce further damages, particularly proven increased interest rates, shall remain unaffected thereof. The default consequences shall arise automatically, i.e. independent from the enforcement of default. In the event of default all our accounts receivable, including bills accepted but not yet discharged, shall become due in cash immediately. The Purchaser shall no longer be entitled to sell goods being in our ownership or co-ownership (see clause 6 Retention of title) and shall be committed to provide adequate collateral to us. We reserve the same right in the event of reasonable doubts regarding the Purchaser's creditworthiness. In this case we shall furthermore be entitled to make the delivery of other goods only after the provision of adequate collateral and/or cash in advance.

4.4 Payment shall principally be made in the form of bank transfer. Any payment shall be made with the effect of discharging the debt and exclusively to the bank indicated in the invoice, to which we have assigned our claims arising out of our business connection.

4.5 The Purchaser shall only be entitled to offset or retain payments if the Purchaser's counterclaim(s) is/ are not disputed and legally ascertained. The retention arising out of the same contractual relationship shall, however, remain unaffected thereof.



5. TRANSFER OF RISK

5.1 Any risk shall be transferred to the Purchaser after the Purchaser has been notified by us that the goods are reported to be ready for collection or shipment, but no later than on the date on which the goods have left our factory or have been taken over by the Purchaser in our factory. This shall also apply in the event of carriage paid delivery and if the goods are shipped by us upon request of the Purchaser. In the event of shipment being delayed at the Purchaser's request or due to reasons attributable to the Purchaser, the risk shall be transferred to the Purchaser for the duration of the delay.

6. RETENTION OF TITLE

6.1 We reserve the title to the property in goods supplied until full payment of any accounts, including accounts accruing in the future, arising out of the business connection, even if payments referring to particularly identified accounts are made. In the event of open account the reserved property shall be deemed collateral to our current account balance claims.

6.2 Goods subject to retention of title may only be sold according to the rules of business transactions. This shall no longer apply in the event of the Purchaser being on default. The Purchaser shall not be entitled to pledge or assign goods as collateral. Pledging on the part of any third parties shall immediately be notified to us.

6.3 Any manipulation, processing or connection of our goods performed by the Purchaser shall in all cases be made for us without the event of liabilities accruing to us. In the event of processing, manipulation or connection to other items not under our ownership, we reserve the right of co-ownership to the new item in an amount resulting from the ratio of the invoice value of processed, manipulated or connected goods subject to retention of title to the value of the new item.

6.4 For collateral purposes the Purchaser shall fully assign to us all claims against any third parties, including any current account balance claims on an open item basis, attributable to the Purchaser in connection with the use of goods subject to retention of title, particularly through resale, manipulation and processing or due to another legal cause (e.g. unlawful act) in the amount of the invoice value of our goods. Any assignment shall act as collateral to any of our claims and particularly to indemnity claims raised against the Purchaser. The Purchaser shall be entitled to collect assigned claims prior to our revocation. In the event of default or other indications of the Purchaser's financial difficulties, the direct debit authorisation shall expire without express revocation.

6.5 If the total realisable value of existing collateral exceeds our claims by more than 10 %, we shall in this extent be committed to release collateral selected by us on the Purchaser's request.

6.6 In the event of default, the Purchaser shall, upon our request, be committed to provide particulars suitable for the enforcement of our rights of retention of title, in particular to issue a statement on goods subject to retention of title and their destination.

6.7 If the Purchaser fails to accomplish the Purchaser's commitments arising out of the mutual business connections, the Purchaser's right to own goods subject to retention of title shall expire. We shall in such cases be entitled to take back goods subject to retention of title. We shall also be entitled to enter the Purchaser's company grounds or other premises for the purpose of taking possession of goods subject to retention of title. Taking back goods subject to retention of title shall constitute rescission from the contract. We shall be entitled to commercialise goods subject to retention of title after their return. Proceeds resulting from the valorisation shall be reduced by reasonable valorisation costs and then be offset against amounts owed by the Purchaser.

7. WARRANTY

Unless other directives or references based on special written agreements are to be observed and become an integral part of the contract, we deliver subject to and in accordance with the requirements stipulated by the regulations of the Association for Electrical, Electronic and Information Technologies (VDE).

7.1 The Purchaser's claims for defects shall only be in force if the Purchaser duly observes the Purchaser's obligation stipulated by § 77 HGB (Code of Commercial Law) to inspect the goods and give notice of defects. The Purchaser shall conduct factual and functional inspection and testing of incoming goods immediately upon receipt and by reference to our shipping documents. The Purchaser cannot be exonerated of the obligation to perform inspection. Costs incurring to the Purchaser due to processing of goods without prior inspection shall always be borne by the Purchaser.

7.2 Shortfall quantities and/or apparent defects shall only be warranted upon written notice of the complaint specifying the order and delivery note data and within a period of 10 workdays after distribution.

7.3 If apparent defects have not been contested within the aforementioned period, any claims of the Purchaser in this respect shall be excluded.

7.4 Unapparent defects emerging in the course of time shall immediately be communicated to us by the Purchaser.

7.5 The return of goods necessary in the event of defect requires our prior consent. In this respect the legal regulation on the taxing of costs applies. Returns made without our prior consent shall not require our acceptance. In this case the Purchaser shall solely bear the total costs of return.

7.6 In the event of supplementary performance in the form of a new delivery due to a justified notice of defects, the provisions on the delivery period apply accordingly. We require an appropriate period of time of at least three weeks to be granted to us for rectifying the defects in the form of subsequent improvement.

7.7 The presence of a defect shall constitute the following rights to the Purchaser:

7.7.1 In the event of defectiveness, the Purchaser shall first of all have the right to demand supplementary performance from us. Any supplementary performance can according to the Purchaser's choice be effected by means of removal of the defect or delivery of new goods. We reserve the right to refuse the form of supplementary performance chosen by the Purchaser, if it would only be possible at disproportional cost.

7.7.2 In the event of failed efforts to provide supplementary performance, we reserve the additional right to undertake further supplementary performance according to the conditions indicated under 7.7.1 and within an appropriate period of time. The Purchaser shall have the right to rescind from the contract or to abate the purchase price only if the repeated supplementary performance has failed.

7.7.3 Claims of the Purchaser due to expenditures required for the purpose of supplementary performance, particularly for carriage, route, labour and material costs, shall be excluded insofar as the expenditures are increasing because the delivery item has subsequently been transferred to a location other than the Purchaser's establishment, unless the transfer corresponds to its intended use.

7.7.4 Unless the defect has been fraudulently concealed by us, the warranty period shall principally last one year from the date of delivery of the goods. The Purchaser shall in any case furnish proof of the defect being already present on delivery.

7.7.5 Warranty claims shall principally be excluded if inappropriate modifications, repairs or other interventions have been performed by the Purchaser or any third parties without absolute necessity and the contested defect was caused, or may have been caused, in this way.

8. RIGHTS IN TOOLS

8.1 The Purchaser or any third parties shall not acquire any rights (transitional right, rights of use etc.) by reimbursing portions of the costs for tools. In the event of industrial property rights of third parties being infringed due to deliveries according to drawings or other information provided by the Purchaser, the Purchaser shall indemnify us against any claims thereto.

9. LIABILITY

9.1 Unless otherwise specified in these General Terms and Conditions including the provisions below, we shall be liable for any breach of contractual and noncontractual obligations according to the relevant legal regulations.

9.2 Unless none of the regulations below applies, we shall in the event of damages – for whatever legal reason – principally be liable only in case of malice and culpable negligence: In the event of ordinary negligence we shall only be liable:

a) for damages resulting from injuries to the body, life or health;

b) for damages resulting from the violation of an integral contractual obligation (i.e. an obligation of such importance that its accomplishment facilitates due execution of the contract in the first place and its observance is and may regularly be trusted by the contractual partner); in this case our liability shall, however, be limited to the reimbursement of the predictable damage typically occurring.

9.3 The limitation of liability according to subparagraph 9.2 shall not apply if we have fraudulently concealed any defect or have assumed warranty for the quality of the goods. The same shall apply to claims of the Purchaser according to the Product Liability Law.

10. EXPORT REGULATIONS

If a national Purchaser exports goods abroad, the Purchaser is committed to verify whether the exported goods are subject to restrictions of the German Foreign Trade and Payments Act. The exporter of the goods bears the sole responsibility for observing the respective export regulations. This also applies to the provisions of US foreign trade legislation. We shall in no case assume any warranty that products supplied by us comply with such regulations.

11. PLACE OF JURISDICTION

As far as the customer is a merchant in accordance with the Code of Commercial Law, a legal entity of public law or a special fund under public law, our company headquarters shall be the exclusive place of jurisdiction for any legal action taken against us.

In the event of legal action against the Purchaser, we shall also be entitled to bring legal proceedings before a court locally competent for the headquarters or a subsidiary of the Purchaser.

12. APPLICABLE LAW

These General Terms and Conditions and any legal relationships between us and the Purchaser shall exclusively be governed by the law of the Federal Republic of Germany.

The UN Convention on Contracts for the International Sale of Goods (CISG) shall be excluded.

13. FINAL PROVISIONS

In the event of any regulation under these General Terms and Conditions being void or becoming unenforceable, the effectiveness of the other conditions shall remain unaffected thereof. In this case both parties shall be committed to introduce an effective and enforceable clause, corresponding as far as possible to the economic and non-material goals within the legal restrictions, in place of the void and unenforceable clause.





T.K. Kabel oHG

Geschwister-Scholl-Straße 11 71384 Weinstadt

Phone +49 (0) 7151/60 68 70

Fax +49 (0) 7151/60 91 00

info@tk-kabel.de · www.tk-kabel.de

Catalogue download: catalogue.tk-kabel.de

QR-Code scannen und Produkt-
katalog direkt auf dem Handy
anschauen:

